



MEDESY[®]
ITALY



GENERAL CATALOGUE | CATALOGO GENERALE

HIGH QUALITY DENTAL INSTRUMENTS

MEDESYS is the **story of a family**.
MEDESYS is the **story of a great passion forged in steel**.
MEDESYS sums up the **history of an entire village** which has been handling and transforming steel for more than 600 years.

At MEDESYS fundamental values are passed on from generation to generation: devotion to work, special attention to detail, respect and even self-denial, truly necessary for attaining constant improvements, these are indeed our main drivers.

At MEDESYS we all give our best every day, as we all know that just by giving our best we can satisfy our customers providing excellent quality products and dedicated service: we cannot be just good, we must be the best.

If today we are a much larger family it is mainly because of your preference, we feel grateful and proud for your loyalty, thanks and **welcome in our family!**

MEDESYS è la **storia di una famiglia**.
MEDESYS è la **storia di una passione forgiata nell'acciaio**.

MEDESYS è la storia di un intero paese che da 600 anni lavora l'acciaio

In MEDESYS si trasmettono da generazioni i valori fondamentali che rendono unica la nostra produzione: la dedizione per il lavoro, la cura per i dettagli, il rispetto e anche il sacrificio, necessario per potersi costantemente migliorare.

Ogni persona in MEDESYS dà il meglio di se stessa, perché sappiamo che solo dando il massimo possiamo soddisfare i nostri clienti con la qualità dei nostri prodotti ed il nostro servizio: non basta essere bravi, bisogna essere i migliori.

Se siamo diventati una grande famiglia è grazie a voi ed alla vostra preferenza per i nostri strumenti: grazie e **benvenuti nella nostra famiglia!**

Claudio Ghezzi, Ceo & President

Guglielmo Ghezzi, MEDESYS founder
Guglielmo Ghezzi, fondatore di MEDESYS



Claudio Ghezzi with daughter Lisa and son Diego
Claudio Ghezzi con i figli Lisa e Diego



MEDESYS TODAY

MEDESYS OGGI

- Italian craftsmen
- More than 3.000 high quality instruments
- 600 Years of history and tradition
- 105 Countries presence
- 16 the network of companies which contribute to the realization of the MEDESYS instruments

- Artigiani italiani
- Oltre 3.000 strumenti di alta qualità
- 600 anni di storia e tradizione
- Presente in 105 Paesi
- 16 le aziende che contribuiscono alla realizzazione degli strumenti MEDESYS





105 COUNTRIES

105 PAESI

Nowadays MEDESYS is firmly present and appreciated in more than 105 international markets for the excellent quality of its products refined in all the details, from a technical point of view and in terms of design.

Al giorno d'oggi MEDESYS è radicata in 105 Paesi ed altamente apprezzata a livello internazionale per l'eccellente qualità dei suoi prodotti, rifiniti in ogni singolo dettaglio, sia dal punto di vista tecnico, sia prettamente di design.



30 INTERNATIONAL EXHIBITIONS

30 PRESENZE IN FIERE INTERNAZIONALI

Every year MEDESYS actively participates to more than 30 international exhibitions and scientific congresses, autonomously as MEDESYS trademark or in support of the activity of its precious partners during national dental events.

Ogni anno MEDESYS partecipa a più di una trentina tra fiere internazionali, congressi scientifici e conferenze, sia in autonomia sia in supporto all'attività svolta dai preziosi partner.



BEYOND THE INSTRUMENT: MEDESYS IS MORE

DIETRO GLI STRUMENTI: MEDESYS È MOLTO DI PIÙ

These are the **core values** and pillars which define and sustain MEDESYS and each single MEDESYS product is the essence of this precious heritage. The perfect combination and balance of these elements are the key factors enabling us to keep on creating unique and original high-quality instruments.

The **most important asset is our 600 years tradition**: there is no **better guarantee** for our customers, perfection of design and superior performance are not pure chance, but the patient distillation of our generous history and long tradition.

Questi sono i **valori fondamentali** che caratterizzano MEDESYS e si concretizzano in ogni suo strumento. La perfetta combinazione di questi elementi è il fattore chiave che ci permette di creare gli strumenti di qualità unici nel mercato.

L'ingrediente più importante ed unico è **la nostra tradizione di 600 anni**: **assoluta garanzia** sulla qualità e precisione dei nostri prodotti.



WHY CHOOSE MEDESYS?

PERCHÉ SCEGLIERE MEDESYS?



Lucia
Export dept. / Ufficio Export

“Because you can breathe **our Italian heart and passion** in all our products and in our service.”

“Per lo stile italiano che contraddistingue il nostro servizio e i nostri prodotti.”



Alba
Accounting Manager / Responsabile contabilità

“For the **excellent service**. We all bend over backwards to cover the needs and find the most precise solutions for our customers.”

“Per l'ottimo servizio. Tutti ci facciamo in quattro per dare servizio e trovare soluzioni al fine di accontentare in tutto e per tutto i clienti.”



Veronica
Logistic dept. / Reparto spedizioni

“We are very flexible and we take pleasure in covering also specific requests such as **customized products** or personalized laser etching on the instruments.”

“Siamo molto disponibili alle esigenze di personalizzazione dei clienti, come strumenti realizzati su richiesta del cliente e marcature personalizzate.”



Marinella
Production dept. / Reparto produzione

“Because it is a most reliable Company providing very good quality products: **each item is carefully checked** during each single manufacturing phase.”

“Per la serietà dell'azienda e la qualità degli strumenti: il prodotto è seguito in ogni singola fase, controllata nei minimi dettagli.”



Franca – Chief of Quality control dept.
Responsabile controllo qualità

“Because we **are a TEAM**, and as they say, never change a winning team.”

“Perché siamo una squadra e squadra che vince non si cambia!”



Sandra
Chief Logistics Officer / Responsabile logistica

“Because more than **105 Countries** keep on choosing us every day, we invite you to test us!”

“Perché ci hanno già scelto 105 Paesi! Metteteci alla prova!”



Mario
Production Chief / Responsabile produzione

“Because the company has a **solid historical background** and looks to the future with the great enthusiasm of young generations.”

“Perché è un'azienda con una bella storia alle spalle e che guarda al futuro con occhi giovani e pieni di entusiasmo.”



Stefano
Sharpening & finishing dept. / Reparto affilatura

“Because the Company carries on the value of **traditional artisanal work** and the **MADE IN ITALY** worldwide.”

“Perché mantiene la tradizione che per anni ha reso il prodotto made in Italy eccellente, ineguagliabile e vantato da tutti: l'Artigianato.”



Dylan
Production dept. / Reparto produzione

“Because we have adopted precise and **highly sophisticated processes** for the production, a real guarantee for efficiency and outstanding durability of our products.”

“Per gli svariati e sofisticati processi impiegati per la realizzazione dei suoi prodotti che ne garantiscono l'affidabilità e la durata nel tempo.”

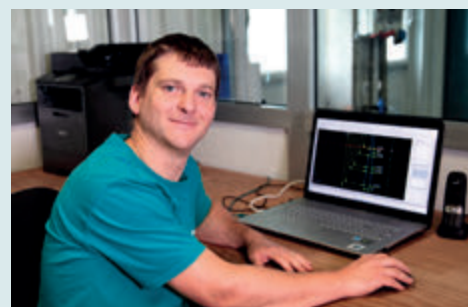

Ferruccio
CNC dept. / Reparto macchinari CNC

“Because it is a **dynamic Company** in constant evolution aiming at improving its products and services day by day.”

“Perché è un'azienda in continua evoluzione che punta al continuo miglioramento.”

BACK TO THE ORIGIN OF THE LEGEND OF MANIAGO

QUANDO NASCE LA LEGGENDA DI MANIAGO



An old legend says that Maniago was already famous during the Roman period for its skills in the manufacture of knives and similar tools and that many Roman soldiers had their arms fabricated by these gifted smiths of the far North East. Maniago was so renowned that a nearby village dating back to around 1.000 AD, sited at the edge of the ancient Roman road linking Julia Concordia and the Alps, is still called today “Poffabro”, which means *pratum fabri* (smiths field).

La leggenda narra che la bravura di Maniago nel costruire coltelli ed altri attrezzi ad essi connessi fosse già famosa ai tempi dei Romani, i quali si facevano costruire le loro armi d’asta proprio a Maniago: tale era la sua fama che un villaggio ad esso confinante e risalente al 1.000 d.C., dove passava la strada Romana che da Julia Concordia si inoltrava nelle Alpi, si chiama ancor oggi ‘Poffabro’, ovvero *pratum fabri*.



600 YEARS OF HISTORY

600 ANNI DI STORIA

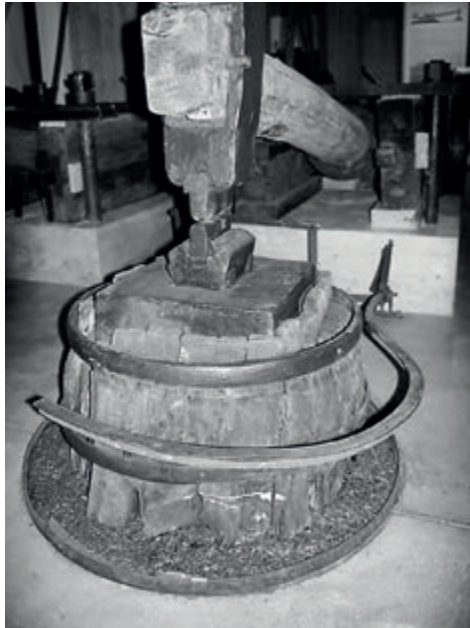

1380 AD

The beginning
L'inizio

31st March 1380: 600 years ago the chiefs of the most important families of Maniago met to discuss and to take decisions on various matters: among them there was Nicolussio, the first smith of Maniago.

31 marzo 1380: 600 anni fa i capi famiglia di Maniago si incontrarono per deliberare su varie tematiche: tra essi c'era Nicolussio, il primo fabbro di Maniago.

1400 AD

Water as an essential source of energy
L'acqua, una fonte di energia indispensabile

Thanks to water which gave power to an increasing number of helve hammers, the smiths' anvils, Maniago's blacksmiths increased their production and became more skilled day by day: at the beginning it was mostly tools related to agrarian work, such as ploughshares, axes and scythes, afterwards the technique rapidly progressed and specialized into what was later renowned as 'the smiths'art & craft workshop'.

Grazie all'acqua che alimentava un numero crescente di battiferri chiamati magli a testa d'asino, il lavoro dei fabbri di Maniago aumentò sensibilmente e soprattutto divenne più articolato e specializzato: dall'iniziale produzione degli attrezzi legati al lavoro agricolo, come vomeri, falci, coltellacci e roncole, la tecnica progredì rapidamente, si specializzò e pose le basi allo sviluppo dell'arte fabbrile e delle botteghe artigiane.

1450 AD

The blacksmiths' anvils
I battiferro

1492

Italian navigator Cristoforo Columbus discovers the land today known as America. Il navigatore italiano Cristoforo Colombo scopre quella che oggi è l'America.

During the Middle Ages water had become an essential source of energy since it supplied power to drive mills, sawmills, bellows, spinning-mills and forges. The first anvil started to operate in Maniago thanks to the authorization given to Count Nicolò of Maniago by the Venetian Republic for the canalization of the Colvera stream into an irrigation ditch.

Nel Medioevo l'acqua diventò un'essenziale fonte di energia poiché alimentava mulini, segherie, mantici, filande e fucine. Il primo battiferro iniziò a lavorare a Maniago su autorizzazione attribuita dalla Serenissima Repubblica di Venezia al Conte Nicolò di Maniago.



1500 AD

Arms for the Venetian Republic
Armi per la Repubblica di Venezia

During the XVI century the blacksmiths of Maniago were able to produce also tools of very great prestige, such as arms for the Venetian Republic. Nowadays the excellent ability of these skilled craftsmen is renowned even in Hollywood where the tool-creations of Maniago have been used for many movies, such as Braveheart, Robin Hood and The Lord of the Rings.

Durante il XVI secolo i fabbri di Maniago erano già in grado di realizzare prodotti di un certo prestigio, come le armi per la Repubblica di Venezia. Oggi le eccellenti abilità degli ingegnosi artigiani sono ammirate perfino a Hollywood, dove le riproduzioni di armi fatte a Maniago sono utilizzate in film famosi, come Braveheart, Robin Hood e Il Signore degli Anelli.



1700 AD

The craft workshops
Le botteghe artigiane

The craft workshop appeared to satisfy a new demand of working tools increasingly small in size and dedicated to specific uses, such as pocket-knives, scissors and surgical instruments. These new small tools had to be extremely precise and also have a nice design: precision and an esthetical style defined the new production parameters of the smiths, then called '*fâvri da fin*'.

La crescente domanda di strumenti da lavoro sempre più piccoli, perfetti in ogni particolare e dediti a specifici utilizzi, come coltelli da tasca, forbici e strumenti chirurgici, diede l'input alla nascita delle botteghe artigiane: questi nuovi strumenti dovevano essere estremamente precisi ed allo stesso tempo gradevoli dal punto di vista del design; precisione e gusto estetico definirono i nuovi parametri per il lavoro dei fabbri, chiamati così '*fâvri da fin*'.



1800 AD

The great economic growth
Il grande sviluppo economico

The work of smiths became so predominant as to further increase the importance of Maniago; since then the town has been renowned as 'the city of the cutleries'. As iron was not easily available on the territory, Maniago smiths preferred to focus on the concept of highest quality rather than on quantity and developed a superior technique: Maniago's products were indeed of a higher quality if compared with the production of other Countries.

L'arte fabbrile assunse sempre più prevalenza all'interno della comunità, tanto da far identificare Maniago come 'la città delle coltellerie'. Data la scarsità in loco del ferro, Maniago preferì focalizzarsi sull'elevata qualità delle sue creazioni, piuttosto che sulla quantità, sviluppando così una tecnica avanzata: i prodotti di Maniago erano sicuramente di qualità e design più elevato rispetto a quelli di altri Paesi.

600 YEARS OF HISTORY

600 ANNI DI STORIA

Grinding wheels / Finitura alle mole



1900 AD

**Smiths' art in Maniago
L'arte dei fabbri di Maniago**

1935 AD

At the beginning of the XX Century metals started to be transformed into tools indispensable for surgery and agriculture: incandescent iron was wrought and shaped into rough tools which were then finished into well-refined instruments by skillful hands.

Agli inizi del XX secolo il metallo veniva lavorato per creare strumenti indispensabili per l'agricoltura e la chirurgia: il metallo incandescente era modellato in strumenti grezzi che venivano poi rifiniti in utensili raffinati da mani abili.



Technical drawings of surgical instruments made by Guglielmo Ghezzi in 1935.

Disegni tecnici di strumenti chirurgici realizzati da Guglielmo Ghezzi nel 1935.

Fine smith / Fâvri da fin



The forgers / Forgiatori



Coarse smith / Fâvri da gros



1970 AD

Great economic expansion
Grande espansione economica

In the 70s the introduction of modern specific and precise machines brought about a huge increase in the overall production, Maniago was dynamic and blooming with more than 200 artisanal firms, 15 medium size enterprises and 4 industries. The new technologies paved the way to a diversification and specialization of the production to include other products in addition to classic knives, such as dental and surgical instruments, scissors and shears, kitchenware, corkscrews, potato-peelers, sports and sub knives, turbine-engine blades, fine arts spatulas and many more. In those years Maniago supplied the German Federal Republic Army with more than 380.000 bayonets.

Gli anni '70 furono caratterizzati da un incremento della produzione grazie all'inserimento di macchine moderne specializzate; la realtà produttiva era costituita da 200 aziende artigiane, 15 imprese di media dimensione e 4 aziende industriali. La produzione, non più limitata alla coltelleria, si diversificò specializzandosi in altri ambiti, come gli strumenti dentali, la posateria, le forbici, i pelapatate, i cavatappi, le pale per turbine, le spatole per belle arti, i coltelli per attività sportive, le forbici per giardinaggio e via dicendo. In quegli anni Maniago fornì l'Esercito della Repubblica Federale Tedesca di ben 380.000 baionette.



MANIAGO

MANIAGO

City of cutlery
Città delle coltellerie



Founded in 981 d.C. / Fondato nel 981 d.C.

Maniago's talent for blacksmith art has grown to the point that the town today is identified as the "**City of knives**" by definition.

In the last decades the ability and know-how of Maniago's smiths have been reshaped and adjusted to meet the current needs of modern market: diversification was the key to successfully face the new challenges; Maniago's manufacturers are nowadays leaders in the following sectors:

- Cutleries
- Surgical instruments
- Blades for turbines
- Spatulas for fine arts
- Corkscrews of refined design

L'abilità di Maniago nell'arte fabbrile è tale da avergli attribuito l'identificazione di "Maniago – Città delle coltellerie".

Negli ultimi anni le straordinarie abilità dei fabbri maniaghesi si sono adattate ai bisogni di un mercato sempre più esigente e la diversificazione è stata la chiave per poter affrontare con successo le nuove sfide; i produttori maniaghesi sono infatti leader mondiali nei seguenti settori:

- Coltellerie
- Strumenti chirurgici
- Pale per turbine
- Spatole per belle arti
- Cavatappi di design raffinato



MUSEUM

Museum of cutlery

Il Museo delle coltellerie

The Museum of smith's art and cutlery is housed inside the building which was the first big cutlery industry in Maniago. The museum reconstructs the work environments and tools used from the beginning to the present day thus documenting the historical and technological evolution of the centenary cutlery tradition of Maniago, the different ways of working iron are widely illustrated. The Museum, hosting also several congresses, seminars and conferences, represent a great resource for the town Maniago because it strengthens the collective identity and transmits the values and the knowledge of the ancient blacksmiths to the new generations.

Il Museo dell'arte fabbrile e delle coltellerie è allestito all'interno della prima vera industria di Maniago: all'interno sono ricostruiti strumenti e ambienti di lavoro che documentano l'evoluzione storica e tecnologica della tradizione secolare di Maniago, con i vari metodi di lavorazione dell'acciaio. Il museo, sede anche di numerosi congressi, seminari e conferenze, è una risorsa importante per Maniago: sviluppa il senso di identità collettiva e trasmette alle generazioni a venire i valori e le conoscenze della secolare tradizione dei fabbri di Maniago.



OUR 600 YEARS OF TRADITION ARE THE UTMOST GUARANTEE OF QUALITY FOR OUR CUSTOMERS

**I NOSTRI 600 ANNI DI TRADIZIONE
SONO LA MIGLIORE GARANZIA
DI QUALITÀ PER I NOSTRI CLIENTI**

- MEDESYS is the admirable result of 600 years of knowledge, skill and culture in the creation of surgical instruments.
- History smoothly flows in our products, tradition and culture the fundamental background for our work.
- 600 years of experience: the utmost guarantee for the quality of our products.
- For 600 years artisans have been forging and shaping: driven by passion to produce tools as an expression of art.

- MEDESYS è la concretizzazione di 600 anni di esperienza, abilità e cultura nella produzione di strumenti chirurgici.
- Noi siamo la nostra storia: noi siamo 600 anni di tradizione e cultura.
- I nostri 600 anni di esperienza: sono la tua miglior garanzia di ricevere qualità.
- Da 600 anni i nostri artigiani si dedicano al loro lavoro come se fosse un'arte.



We have refreshed our logo to better enhance the core elements featuring MEDESYS:

- Proud to be an **Italian** Company.
- Our **tradition** covering more than 600 years.

The word “guarantee” on our previous shield was restrictive and did not fully express the concept of essential historical and cultural heritage on which MEDESYS has laid its foundations.

Abbiamo rinnovato il logo focalizzando maggiormente questi elementi fondamentali che caratterizzano MEDESYS:

- L'**italianità** di MEDESYS.
- La **tradizione** di 600 anni.

La parola ‘garanzia’ in precedenza nello scudo era limitativa e non esprimeva bene il concetto di importante eredità storica e culturale di cui MEDESYS è l'espressione.



600
YEARS
TRADITION

®

MEDESYS COMMITDENT

A better world begins with each of us every day! Join our CommitDent philosophy too!

Un mondo migliore inizia ogni giorno con ognuno di noi. Partecipa anche tu alla filosofia CommitDent!

PERSONAL COMMITDENT COMMITDENT PERSONALE

Our employees are the most precious asset for MEDESYS. For this purpose, MEDESYS has acquired a **next-generation semiautomatic defibrillator** and hosted a utilization training course for the entire staff.

I nostri collaboratori sono la risorsa più preziosa di MEDESYS. A tal fine MEDESYS si è dotata di un **defibrillatore di nuova generazione semiautomatico** ed ha fatto un **corso di formazione al suo personale** per l'utilizzo dello stesso.



SOCIAL COMMITDENT COMMITDENT SOCIALE

We are extremely proud to be participating to the **AMS Foundation** project, founded by Dr Alejandro Méndez Silva, which offers a fully free multidisciplinary program focusing on the treatment of children born with cleft palate or lip cleft condition.

Siamo fieri di partecipare al progetto della **Fondazione AMS**, fondata dal Dr Alejandro Méndez Silva, che mette a disposizione a titolo totalmente gratuito un programma multidisciplinare focalizzato nella cura dei bambini affetti da labbro leporino.



For additional information on the project contact by:
Per maggiori informazioni contattare:

@ drmendez.fundacionams@gmail.com
fundacion.ams@gmail.com

f **Fundación AMS para labio y paladar hendido AC**

📷 **#fundacionams**

ENVIRONMENTAL COMMITMENT COMMITMENT AMBIENTALE

A full respect for nature and environment are core themes of MEDESYS philosophy, to list some of them:

Il rispetto per la natura e l'ambiente è da sempre al centro della filosofia MEDESYS. Per citare alcuni esempi:

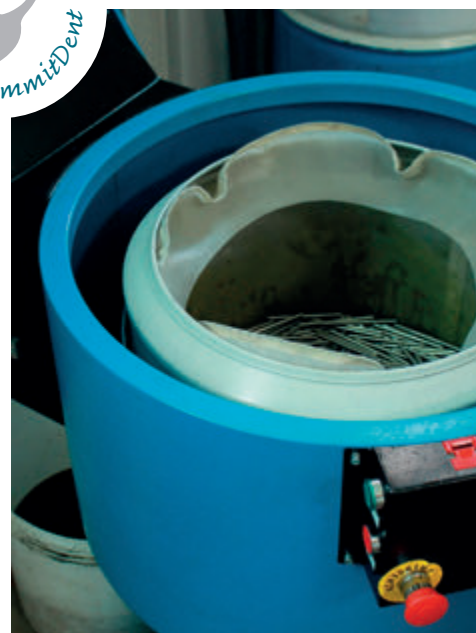

NEW PACKAGING: we have selected a new packaging entirely made with paper certified FSC®, sourced exclusively from well-managed forests in compliance with strict Forest Stewardship Council standards.

NUOVO PACKAGING: abbiamo scelto un nuovo packaging interamente costituito da carta certificata FSC® questo marchio (Forest Stewardship Council®) identifica che il prodotto proviene da foreste gestite in maniera corretta.

GREEN ENERGY: MEDESYS invests on renewable and sustainable sources, green energy such as photovoltaic panels.

ENERGIA PULITA: MEDESYS investe nelle risorse rinnovabili e nell'energia pulita, come i pannelli fotovoltaici.

CENTRIFUGES: MEDESYS has adopted some devices which clean the instruments from manufacturing residual oils, which are then recycled.

CENTRIFUGHE: MEDESYS si è dotata di alcune macchine che attraverso la forza centrifuga ripuliscono gli strumenti dall'olio utilizzato in precedenti fasi lavorative che viene poi riciclato.



MEDESYS INNOVATION

INNOVAZIONE MEDESYS

MEDESYS is anchored to the values of the past but also oriented to the future: the huge investments on sophisticated technological machineries confirm MEDESYS commitment on constant innovation.

MEDESYS ha il cuore ben saldo nella propria cultura ma è al futuro che volge il suo sguardo: gli ingenti investimenti in nuovi sofisticati macchinari confermano l'impegno di MEDESYS nell'innovazione continua.

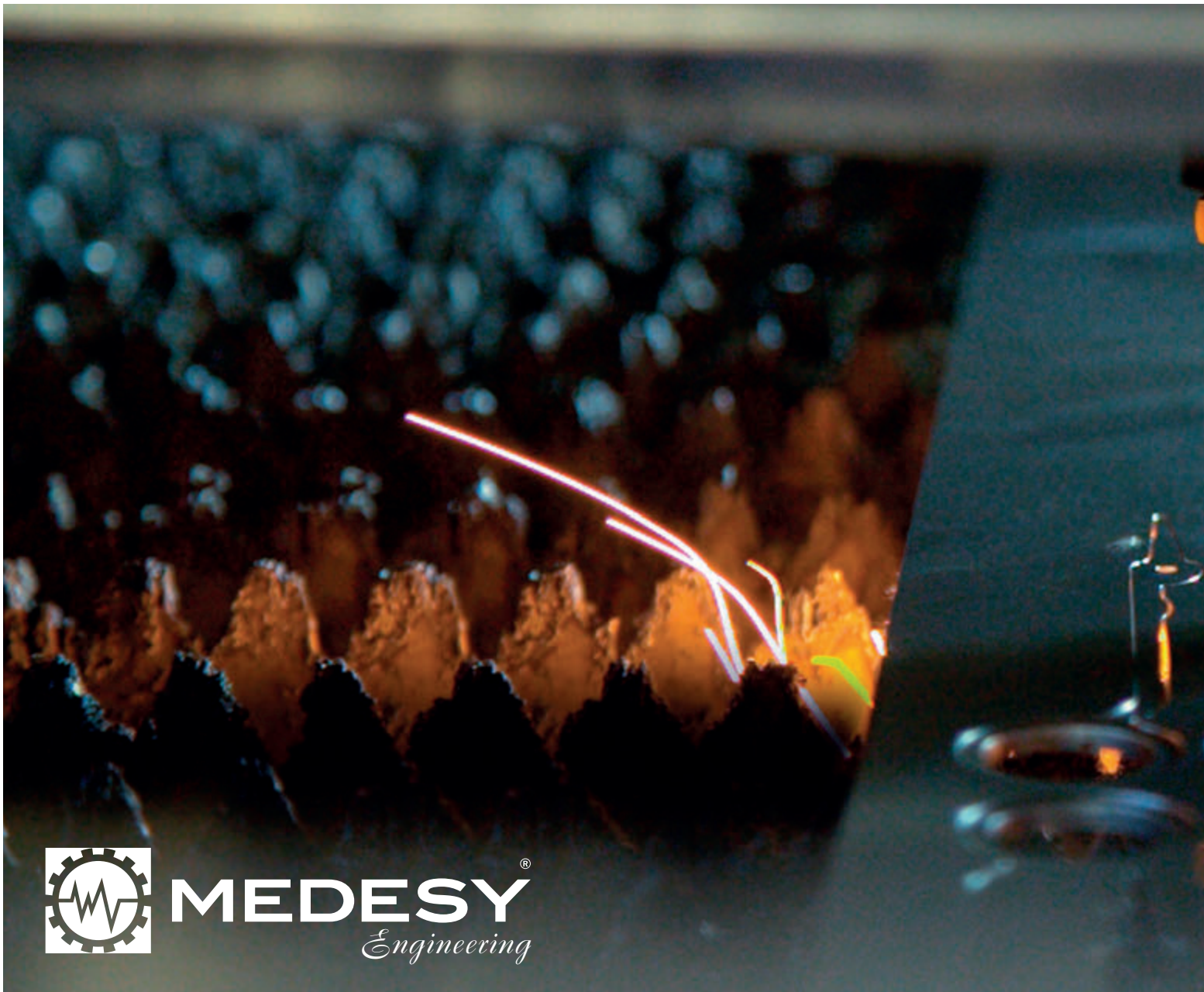

MEDESYS[®]
Engineering

Laser cut / Taglio laser



OUR RESEARCH

LA NOSTRA RICERCA

From a daily contact with our customers and the special attention we confer to our partners' needs we draw the motivations and the suggestions to keep on improving our instruments with the purpose of facilitating the techniques and the daily tasks of dental practitioners. MEDESYS works in close cooperation with opinion leaders and professors of worldwide universities in order to design and produce the best innovative instruments, such as Dr. F. Comella's drop shape mirror, the new Inox syringe or the High Tech BLK.

We are constantly working on the research and development of:

- New instruments
- New materials
- Different surface treatments
- New surgical techniques

The huge investments on last generation technological machineries as well as the opening of a new production factory prove the great ambition and strong will of MEDESYS Management to keep on improving the Quality Standard.

Il quotidiano contatto con i nostri clienti e la speciale attenzione che dedichiamo alle singole esigenze dei nostri partner ci danno le motivazioni ed i giusti input per migliorare continuamente i nostri strumenti, con lo scopo ultimo di agevolare le tecniche e le attività quotidiane dei professionisti. MEDESYS lavora in stretta collaborazione con opinion leader e professori di università di tutto il mondo, al fine di progettare e produrre strumenti migliori ed innovativi, come lo specchio a forma di goccia Dr. F. Comella, la nuova siringa in inox e le nuove forbici High Tech BLK.

Lavoriamo ed investiamo costantemente su:

- Sviluppo di nuovi strumenti
- Sviluppo di nuovi materiali
- Sviluppo di differenti trattamenti di superficie
- Sviluppo di nuove tecniche chirurgiche

Gli enormi investimenti in macchinari di ultima generazione tecnologicamente avanzati e l'apertura del nuovo stabilimento di produzione dimostrano la forte volontà e l'orientamento del MEDESYS Management nel voler aumentare costantemente lo standard qualitativo dei nostri prodotti.

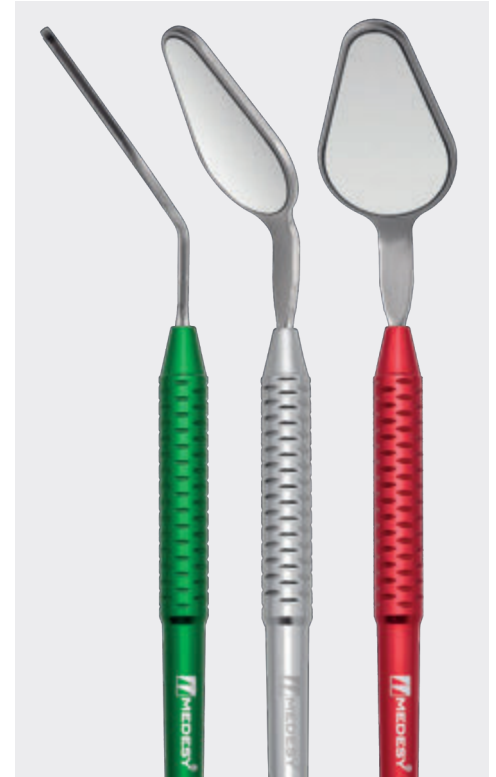

DALILA[®]

MEDESYS HANDLE

MANICO MEDESYS

Our heritage and background are the pillars as well as the engine of MEDESYS production where each single instrument is the perfect combination between artisanal expertise and technological approach: the added value of our handle, DALILA, is the expression of our artisanal culture and a strong investment in innovation and research. Our purpose: offering you high-performance instruments which may improve and fully respond to your daily needs.

La nostra cultura e la nostra secolare esperienza sono i pilastri e la principale energia della produzione MEDESYS: ogni singolo strumento è la concretizzazione del perfetto equilibrio tra esperienza artigianale e sviluppo tecnologico; il valore aggiunto di DALILA, il nostro manico, testimonia sia la nostra cultura sia il nostro costante investimento in innovazione e ricerca, così da potervi offrire strumenti sempre più rispondenti alle vostre esigenze.

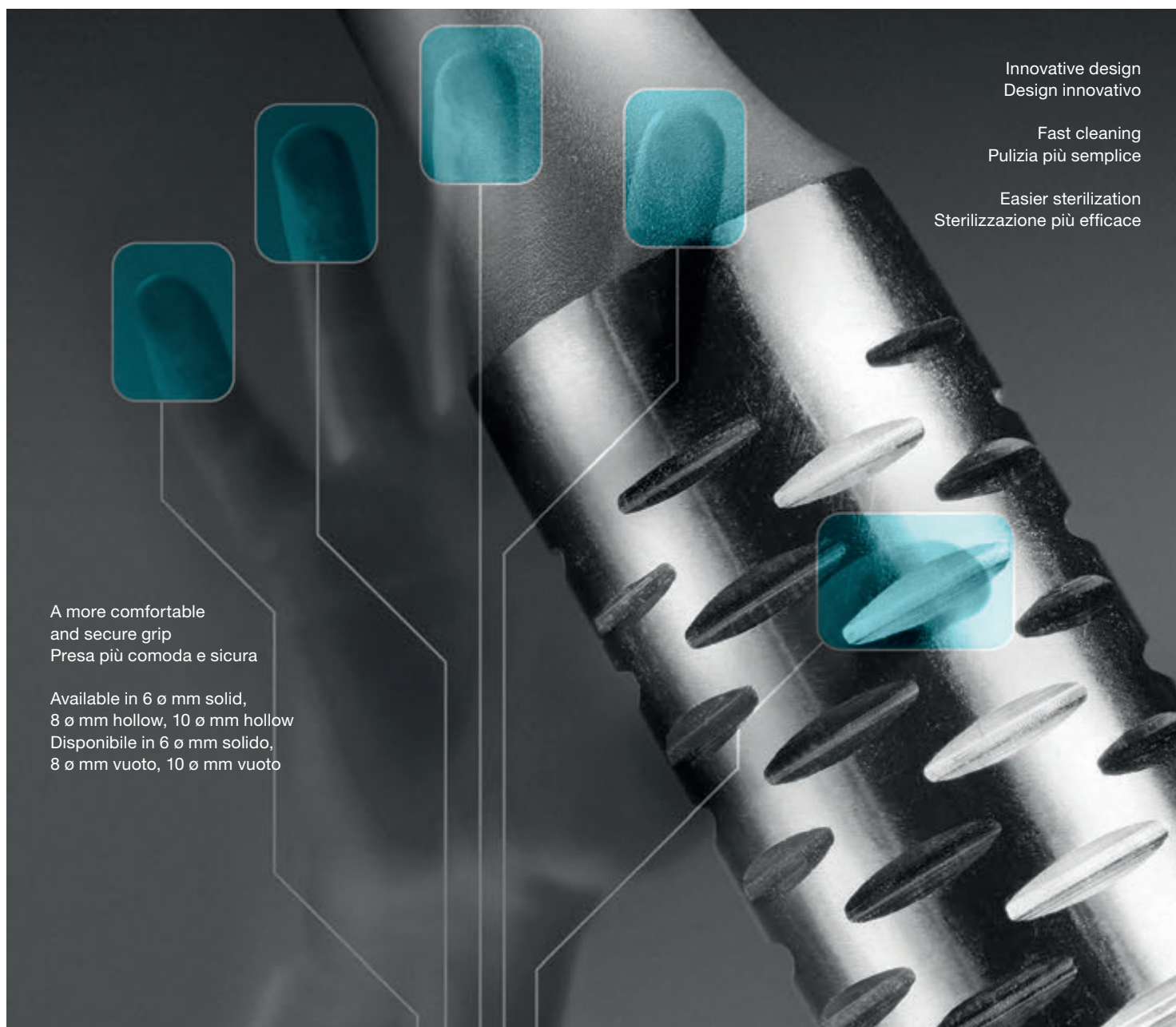

Innovative design
Design innovativo

Fast cleaning
Pulizia più semplice

Easier sterilization
Sterilizzazione più efficace

A more comfortable
and secure grip
Presa più comoda e sicura

Available in 6 ø mm solid,
8 ø mm hollow, 10 ø mm hollow
Disponibile in 6 ø mm solido,
8 ø mm vuoto, 10 ø mm vuoto

Current edition of the catalogue is indicated on the catalogue spine and on the last spine.

L'edizione corrente del catalogo è indicata sul dorso dello stesso e in ultima pagina.



Yellow colour identifies instruments having working or cutting ends reinforced with Tungsten Carbide inserts.
Il colore giallo indica strumenti aventi parte lavorante o tagliente rinforzata con inserti TC.

Thickness of wire and length of the instrument.
Spessore del filo e lunghezza dello strumento.

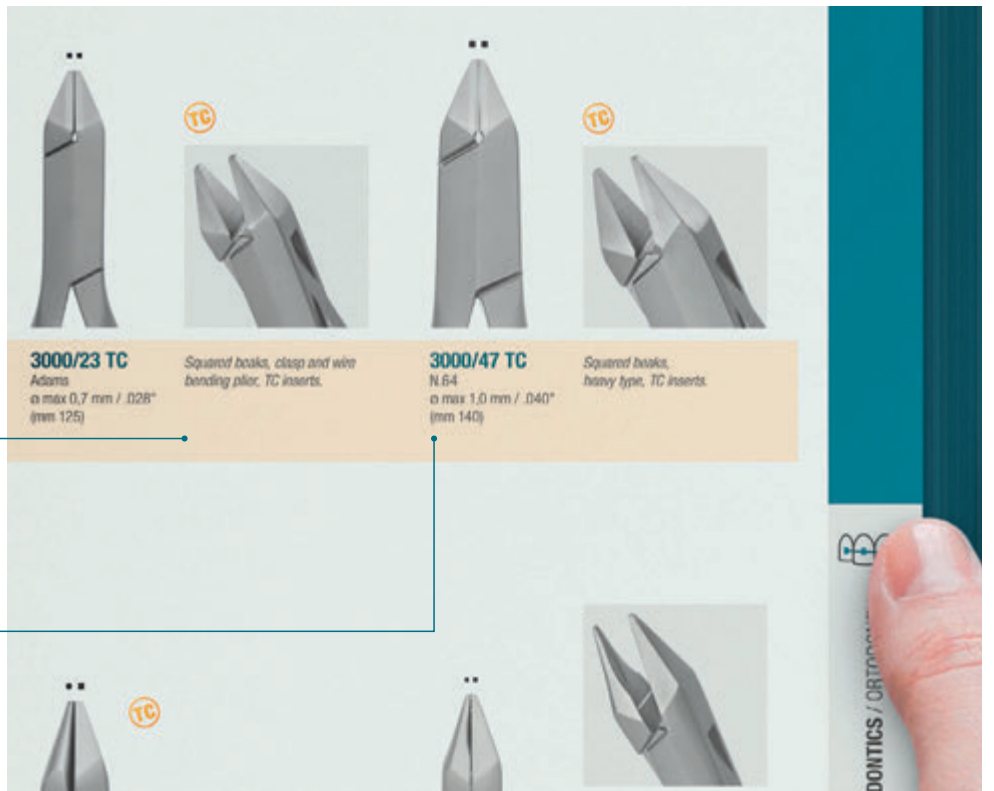



For a faster consultation we grouped the products by category as shown at page A87. Coloured tabs on the edge of the pages refer to each category section.
 Per una veloce consultazione abbiamo raggruppato gli strumenti per categoria, si veda pagina A87: markers colorati a margine pagina indicano le diverse sezioni per categoria.

Below each image you can find code/type of item and other useful information for a better comprehension of the product.
 Sotto ogni immagine sono indicati codice/modello ed alcuni dettagli per una migliore comprensione del prodotto.

Code and model.
 Codice e modello strumento.

1854 (mm 170)
 Mathieu

Suggested needles' sizes.
 Misure suggerite degli aghi.

2-0, 3-0, 4-0

Grey colour identifies standard instruments without Tungsten Carbide inserts.
 Il colore grigio indica gli strumenti standard senza inserti in TC.



SURGICAL / CHIRURGIA

“ MEDESYS IN SPOT

The internal locking hook prevents the needle holder from catching and possibly breaking the glove.

La chiusura interna alta per evitare di pizzicare e rompere i guanti in lattice.

”

Highlighted KEY-SPOTS offer additional information and tips to the final user.
 Riquadri KEY-SPOTS forniscono info e suggerimenti all'utente finale.



SURGICAL / CHIRURGIA

A



DIAGNOSTIC / DIAGNOSTICA

B



PERIODONTAL / PARODONTOLOGIA

C



RESTORATIVE / CONSERVATIVA

D



IMPLANTOLOGY / IMPLANTOLOGIA

E

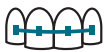

ORTHODONTICS / ORTODONZIA

F



LABORATORY / LABORATORIO

G

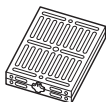

ACCESSORIES / ACCESSORI

H



PERFECT ALVEOLUS with Minimal Trauma!

Alveolo perfetto con minimo trauma!

Clinical Case – Caso Clinico

Extraction of the root
1st premolar (tooth 14)

Estrazione della radice
del 1° premolare (dente 14)



Focus on the perfectly NEAT ALVEOLE and ABSOLUTELY UNDAMAGED and FULLY INTACT GUM.
Notare l'alveolo: nessun trauma, assolutamente integro!

- ✓ Exomed® is designed to perform extractions with minimal trauma.
- ✓ Exomed® is recommended to perform alveolar extractions of teeth with or without crown.
- ✓ Exomed® è progettato per la realizzazione di estrazioni minimamente traumatiche.
- ✓ Exomed® è indicato per l'estrazione alveolare di radici e denti con e senza corona.



Exomed® KIT

Contains / Contiene

- | | |
|----|--|
| 1 | BS – Supports / Basi di appoggio |
| 2 | Extractor / Estrattore |
| 3 | RS 16 – Root screw \varnothing 16 / Viti per radici \varnothing 16 |
| 4 | RS 18 – Root screw \varnothing 18 / Viti per radici \varnothing 18 |
| 5 | COK – Kevlar cord / Cordini in Kevlar |
| 6 | Pliers / Pinze |
| 7 | PUEX – Universal tips / Punta universali |
| 8 | PRA – Prismatic tips for roots / Punta per radici |
| 9 | EL & EC – Manual Root extractors / Estrattori manuali per radici |
| 10 | KL & KC – Screwdrivers / Giraviti |
| 11 | PRS – Bur extender / Prolunga per fresa |

7500/KIT

Clinical Case – Caso Clinico

Extraction of the tooth 36 (1st inferior molar)

Estrazione del dente 36
(1° molare inferiore)

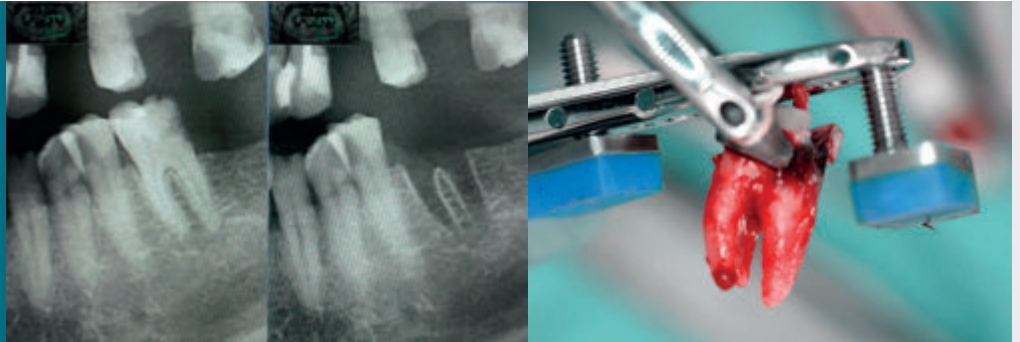

X-ray PRIOR and POST extraction, highlighted is the internal bone which is fully intact and above all the ALVEOLE SITE is PERFECTLY and TOTALLY UNDAMAGED.

Raggi X PRIMA e DOPO l'estrazione, dove si evidenzia l'osso interno perfettamente intatto. ALVEOLO perfettamente INTEGRO.

1 The periodontal and alveolar tissues remain **fully undamaged** after the extraction, no lacerations, no huge bleeding, the neighboring tissues are practically perfect after the operation! I tessuti parodontali ed alveolari rimangono **perfettamente intatti** dopo l'estrazione, assenza di lacerazioni e sanguinamento copioso, anche i tessuti adiacenti rimangono praticamente perfetti!

2 It is a fully reliable alternative technique allowing the immediate insertion of the implant in a perfect and undamaged alveolus. Possibilità di inserimento di un impianto subito dopo l'estrazione: questo perché l'alveolo rimane perfettamente integro.

3 No need to perform a syndesmotomie and luxation before the extraction. Non è necessario effettuare la sindesmotomia e la lussazione prima dell'estrazione.

4 Smaller in size than a forceps: no need for the patient to remain full open mouth as required with conventional techniques. Permette una minor apertura della bocca rispetto alla tecnica tradizionale che impiega le pinze per estrazione, quindi maggior comfort per il paziente.

5 The extraction of **roots** and **damaged teeth** or **partially ruined teeth** is really easier and faster. L'estrazione di **denti**, anche **completamente o parzialmente scoronati**, è effettivamente più semplice e veloce.

6 The extraction made with Exomed® does not require any special high pulling force of the dentist. Le estrazioni con Exomed® sono ottenute esclusivamente con la forza delle due dita: non è necessario pertanto alcuno sforzo.



... and smaller in size than a forceps!
... ed è più piccolo di una pinza!



For additional information about Exomed and to see all clinical cases visit www.exomed.it or address your questions to exomed@medesy.it

Per maggiori informazioni riguardo Exomed e per vedere tutti i casi clinici visitare il sito www.exomed.it o scrivi a exomed@medesy.it

PEDODONTIC TOOTH FORCEPS, SPRINGS LOADED HANDLE

PINZE PER ESTRAZIONE PER BAMBINI, SISTEMA CON MOLLA

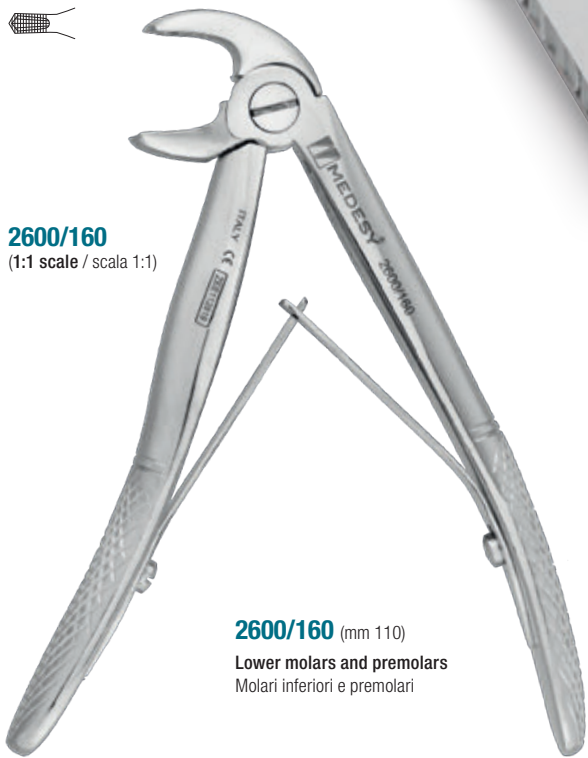

2600/160
(1:1 scale / scala 1:1)

2600/160 (mm 110)
Lower molars and premolars
Molari inferiori e premolari



2600/150 (mm 110)
Lower incisors and canines
Incisivi inferiori e canini



2600/170 (mm 110)
Lower roots
Radici inferiori



2600/101 (mm 115)
Upper incisors
Incisivi superiori



2600/111 (mm 110)
Upper premolars
Premolari superiori

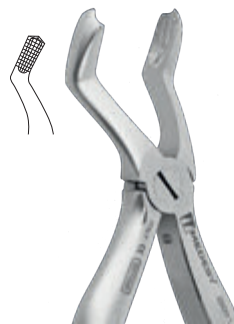

2600/115 (mm 120)
Upper molars
Molari superiori



2600/122 (mm 125)
Upper roots
Radici superiori



SURGICAL / CHIRURGIA

PEDODONTIC TOOTH FORCEPS, ENGLISH PATTERN

PINZE PER ESTRAZIONE PER BAMBINI, FORMA INGLESE

2500/163

(1:1 scale / scala 1:1)



2500/138

Upper teeth and roots, for children
Superiori e radici, per bambini



2500/163

Upper centrals, for children
Superiori centrali, per bambini



2500/37

Upper incisors, for children
Incisivi superiori, per bambini



2500/29-S

Upper roots, for children
Radici superiori, per bambini



2500/159

Upper premolars, for children
Premolari superiori, per bambini



2500/157

Upper molars, for children
Molari superiori, per bambini



2500/158

Upper premolars and molars, for children
Premolari e molari superiori, per bambini



2500/39

Upper molars, for children
Molari superiori, per bambini



2500/39-A

Upper molars, for children
Molari superiori, per bambini



2500/39-R

Upper molars right, for children
Molari superiori destri, per bambini



2500/39-L

Upper molars left, for children
Molari superiori sinistri, per bambini

2500/160
(1:1 scale / scala 1:1)



2500/38

Lower incisors and canines, for children
Incisivi inferiori e canini, per bambini



2500/162

Lower roots and centrals, for children
Radici e incisivi inferiori, per bambini



2500/123

Lower teeth and roots, for children
Inferiori e radici, per bambini



2500/13-S

Lower premolars, for children
Premolari inferiori, per bambini



2500/22-S

Lower molars, for children
Molari inferiori, per bambini



2500/160

Lower molars, for children
Molari inferiori, per bambini



2500/161

Lower molars, for children
Molari inferiori, per bambini



2500/40

Lower molars, for children
Molari inferiori, per bambini



The company was using this tooth forceps "Master sample exposer" in 1930s, to verify dimensions and shapes along production process. Displayed today at the museum, in Maniago.
Espositore utilizzato negli anni '30 per verificare forme e dimensioni delle pinze in produzione. Esposto attualmente presso il museo, a Maniago.

PEDODONTIC TOOTH FORCEPS, SQUARED BEAKS PATTERN

PINZE PER ESTRAZIONE PER BAMBINI, PUNTE A PROFILO QUADRO

2400/133-BC
(1:1 scale / scala 1:1)

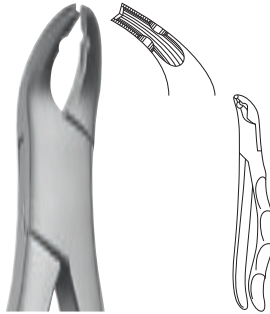
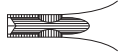

2400/133-BC (mm 125)
Lower teeth, for children
Denti inferiori, per bambini

2400/151-BC (mm 150)
Lower teeth, for children
Denti inferiori, per bambini

2400/101-BC (mm 150)
Upper teeth, for children
Denti superiori, per bambini

PEDODONTIC TOOTH TWEEZERS

PINZETTE PER ESTRAZIONE PER BAMBINI



1029 (mm 160)
Albrecht
Pointed
Appuntite

1030 (mm 160)
Albrecht
Rounded
Arrotondate



Tooth forceps hot forging process.
Fase di stampaggio a caldo di una tenaglia per estrazioni.

PEDODONTIC TOOTH FORCEPS, AMERICAN PATTERN

PINZE PER ESTRAZIONE PER BAMBINI, FORMA AMERICANA



2650/151 Pedo (Cryer, mm 135)

Lower premolars, incisors, roots, universal
Premolari inferiori, incisivi, radici inferiori, universale



2650/203 Pedo (mm 135)

Lower premolars, incisors, and roots, either side
Premolari inferiori, incisivi e radici inferiori, ambo i lati

2650/SET PEDO

Content / Contenuto:

2650/65-69-16-17-18R-18L-203-150-151

Set Pedo tooth forceps, American pattern (9 forceps)

Set pinze modello americano per bambini (9 pinze)



2650/16 Pedo (Harris, mm 135)

Lower molars, cow-horn beak, either side
Molari inferiori, corna di bue, ambo i lati



2650/17 Pedo (mm 135)

Lower molars, either side
Molari inferiori, ambo i lati



2650/65 Pedo (mm 135)

Upper incisors and roots
Incisivi superiori e radici superiori



2650/150 Pedo (Cryer, mm 135)

Upper premolars, incisors, roots, universal
Premolari superiori, incisivi, radici superiori, universale



2650/18-R Pedo (Harris, mm 135)

Upper molars, right
Molari superiori destri



2650/18-L Pedo (Harris, mm 135)

Upper molars, left
Molari superiori sinistri



2650/69 Pedo (Tomes, mm 135)

Fragments, upper and lower
Frammenti superiori e inferiori



SURGICAL / CHIRURGIA

ANATOMIC TOOTH FORCEPS, ENGLISH PATTERN

PINZE PER ESTRAZIONE ANATOMICHE, FORMA INGLESE

2500/1
(1:1 scale / scala 1:1)



2500/1

Upper centrals and canines, wide
Incisivi centrali e canini superiori, larghi



2500/2

Upper laterals and canines
Incisivi laterali, canini



2500/3

Upper crowded incisors and canines
Incisivi superiori scoronati e canini uniti



2500/107

Upper canines
Canini superiori



2500/180

Special for upper centrals and canines deep gripping
Speciale per incisivi e canini superiori attacco profondo



2500/181

Special for upper premolars deep gripping
Speciale per premolari superiori attacco profondo



2500/7

Upper premolars
Premolari superiori



2500/136

Upper centrals premolars and roots
Premolari centrali e radici superiori



2500/4

Lower incisors and canines
Incisivi e canini inferiori



2500/75

Lower incisors and premolars
Incisivi e premolari inferiori



2500/75-A

Lower incisors and premolars
Incisivi e premolari inferiori



2500/137

Lower centrals and roots
Incisivi, canini inferiori e radici



2500/122

Lower centrals and roots
Centrali inferiori e radici



2500/182

Lower centrals canines and premolars deep gripping
Incisivi, canini e premolari inferiori attacco profondo



2500/13

Lower premolars either side
Premolari inferiori destri e sinistri



2500/8

Lower premolars either side
Premolari inferiori destri e sinistri

2500/17
(1:1 scale / scala 1:1)



2500/17
Upper molars, right
Molari superiori destri



2500/18
Upper molars, left
Molari superiori sinistri



2500/18-A
Upper molars either side
Molari superiori destri e sinistri



2500/89
Upper molars, right
Molari superiori destri



2500/90
Upper molars, left
Molari superiori sinistri

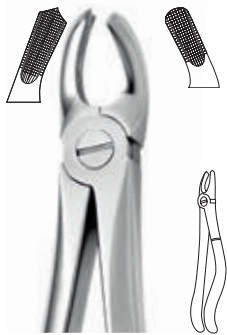

2500/94
Upper molars right
Molari superiori destri



2500/95
Upper molars left
Molari superiori sinistri

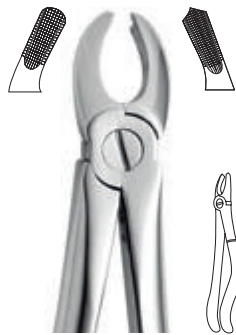

2500/96
Upper molars right
Molari superiori destri



2500/97
Upper molars left
Molari superiori sinistri

2500/96 and 2500/97 have slightly shorter points than 2500/94 and 2500/95.
2500/96 e 2500/97 hanno le punte leggermente più corte di 2500/94 e 2500/95.



2500/67
Upper third molars and upper wisdoms either side
Terzo molare superiore e denti giudizio superiori



2500/67-A
Upper third molars and upper wisdoms either side
Terzo molare superiore e denti giudizio superiori

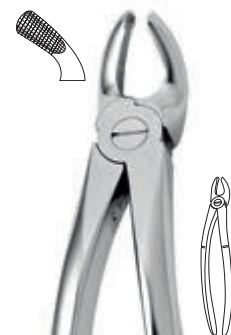

2500/19
Upper third molars and upper wisdoms either side
Terzo molare superiore e denti giudizio superiori



2500/54
For separating upper molars
Per separare molari superiori



2500/55
For separating upper molars
Per separare molari superiori

2500/73

(1:1 scale / scala 1:1)



2500/73

Lower molars
Molari inferiori



2500/73-S

Lower molars
Molari inferiori



2500/73-L

Lower molars
Molari inferiori



2500/21

Lower molars
Molari inferiori



2500/22

Lower molars
Molari inferiori



2500/148 (Balding)

Lower molars
Molari inferiori

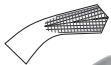

2500/23

Lower molars, right
Molari inferiori destri

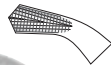

2500/24

Lower molars, left
Molari inferiori sinistri



2500/20

Lower third molars
Terzo molare inferiore



2500/79

Lower third molars and lower
wisdoms either side
Terzo molare inferiore denti
giudizio inferiori destri e sinistri



2500/79-A

Lower third molars
Terzo molare inferiore

COW HORN BEAK
CORNO DI BUE



2500/86

Lower molars decayed
or broken down crowns
Molari inferiori scoronati



2500/86-C

Lower molars decayed
or broken down crowns
Molari inferiori scoronati



2500/91 (Rowney)

For separating lower molars
Per separare molari inferiori



2500/99 (Wood)

Lower molars
Molari inferiori



2500/87

Lower molars decayed
or broken down crowns
Molari inferiori scoronati



2500/51
(1:1 scale / scala 1:1)



2500/51
Upper roots
Radici superiori



2500/51-A
Upper roots
Radici superiori



2500/51-L
Upper roots
Radici superiori



2500/139
Upper roots
Radici superiori



2500/52
Upper roots
Radici superiori



2500/189
Fragments upper roots
Frammenti radici superiori



2500/190
Fragments upper roots
Frammenti radici superiori



2500/41
Upper roots
Radici superiori



2500/49
Upper roots
Radici superiori



2500/30
Upper roots
Radici superiori

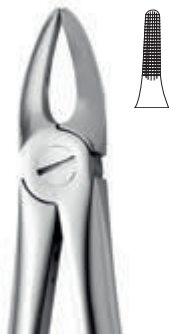

2500/29
Upper roots and incisor
Radici superiori e incisivi



2500/113
Upper roots
Radici superiori



2500/147
Upper roots
Radici superiori



2500/101
Upper roots
Radici superiori

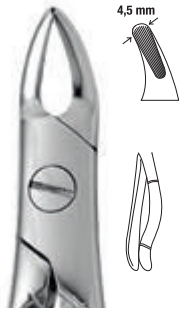

2500/108
Upper roots
Radici superiori



2500/110 (Thorne)
Upper roots
Radici superiori



2500/111
Upper roots
Radici superiori



2500/76
Upper roots
Radici superiori



2500/76-N
Upper roots
Radici superiori

LOWER ROOTS
RADICI INFERIORI



2500/33
Lower roots
Radici inferiori



2500/33-A
Lower roots
Radici inferiori



2500/33-L
Lower roots
Radici inferiori



2500/74
Lower roots and incisors
Radici inferiori e incisivi



2500/74-D
Lower roots
Radici inferiori



2500/74-M
Lower roots and incisors
Radici inferiori e incisivi



2500/74-N
Lower roots and incisors
Radici inferiori e incisivi



2500/114
Lower roots and centrals
Radici inferiori e centrali



2500/143
Lower roots and centrals
Radici inferiori e centrali

2500/187
(1:1 scale / scala 1:1)



2500/187
Lower roots fragments
Frammenti di radici inferiori



2500/46
Lower roots
Radici inferiori



2500/68
Lower roots
Radici inferiori



2500/185
Lower roots
Radici inferiori



2164 (mm 135)
Stieglitz
Curved
Curva



2163 (mm 140)
Stieglitz
Straight
Retta

Splinter forceps
Pinza per frammenti



2162/C (mm 135)
Curved
Curva

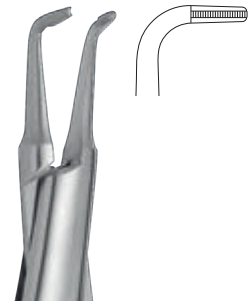

2162/A (mm 130)
Angled 90°
Angolata 90°



2162/R (mm 135)
Straight
Retta

Forceps for pins and broken nerve
Pinza per strumenti canalari e frammenti



SURGICAL / CHIRURGIA

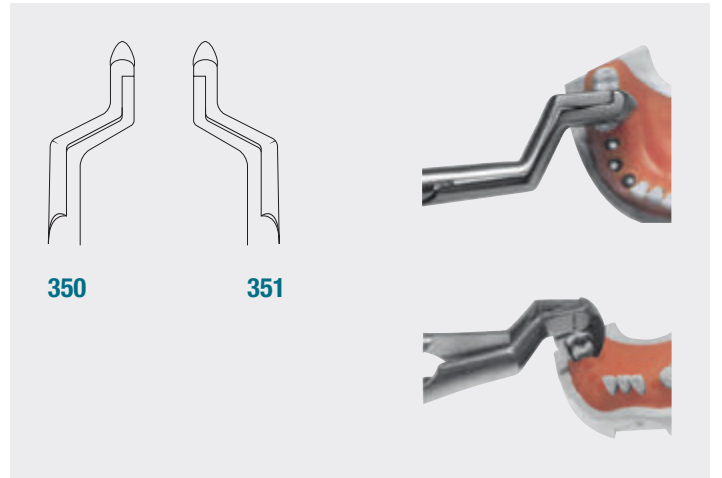
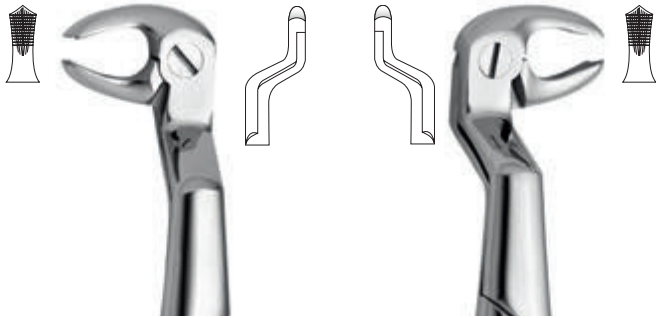

2500/350 (Routurier, mm 180)
Lower molars and wisdoms left
Molari inferiori e denti del giudizio sinistro

2500/351 (Routurier, mm 180)
Lower molars and wisdoms right
Molari inferiori e denti del giudizio destro



2500/130 (Ladmore, mm 190)
Upper wisdoms
Giudizio superiore



2500/221 (Witzel, mm 145)
Universal for upper roots
Universale per radici superiori



2500/223 (Witzel, mm 150)
Universal for lower roots
Universale per radici inferiori

SET OF TOOTH FORCEPS SERIE DI PINZE PER ESTRAZIONI



2500/SET-10

Contains / Contenuto:
2500/74-13-22-79-33
2-7-18A-67-51



The essential extraction Set including Medesy's most representative forceps:

- SET 10 pcs: for the basic extractions, from centrals to the third molars.
- SET 12 pcs: includes 2 additional forceps, the cow horn beak N-86 and the N-74 for lower roots and incisors.

Medesy experience and tradition aims at providing professional kits.

Set essenziale di pinze per estrazione di Medesy:

- SET 10 pezzi: permette di eseguire estrazioni primarie, dai denti centrali sino agli ottavi.
- SET 12 pezzi: composto da 2 ulteriori pinze, la corno di bue n-86 e la n-74 per l'estrazione di radici inferiori e incisivi.

Tutta l'esperienza e tradizione Medesy, da sempre indirizzata a fornire kit professionali a professionisti.

“ MEDESY IN SPOT

*Upon specific request,
the set can be assembled
with different forceps.*

*Su richiesta, è possibile
cambiare il contenuto del set.* ”

2500/SET-12

Contains / Contenuto:
2500/2-13-33-51-7-79
17-18-22-67-74-86



SURGICAL / CHIRURGIA

TOOTH FORCEPS, AMERICAN PATTERN

PINZE PER ESTRAZIONE, FORMA AMERICANA



2650/1

Incisor and canines
Denti incisivi e denti canini



2650/150 (Cryer)

Upper incisors, premolars, roots, universal
Incisivi, premolari e radici superiori, universali



2650/150-A (Cryer)

Upper incisors, premolars, roots
Incisivi, premolari e radici superiori



2650/150-AS

Upper premolars, incisors and roots
Denti premolari, denti incisivi e radici superiori



2650/99-C

Upper premolars, canines and incisors
Premolari, canini e incisivi superiori



2650/32 (Parmly)

Upper molars and premolars, broad beaks
Molari, premolari e radici superiori, punte larghe



2650/32-A (Parmly)

Upper molars, premolars and roots, narrow beaks
Molari, premolari e radici superiori, punte strette



2650/18-R (Harris)

Upper molars, right
Molari superiori destri



2650/18-L (Harris)

Upper molars, left
Molari superiori sinistri



2650/10-S

Upper molars either side
Molari superiori destri e sinistri

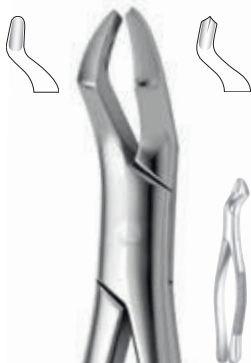

2650/53-R

Upper molars right
Molari superiori destri

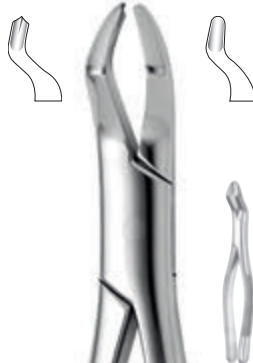

2650/53-L

Upper molars left
Molari superiori sinistri



2650/88-R (Nevius)

Upper molars, right
Molari superiori destri



2650/88-L (Nevius)

Upper molars, left
Molari superiori sinistri



2650/24

Upper molars, either side
Molari superiori destri e sinistri



2650/210

Upper wisdoms, either side
Denti giudizio superiori



2650/69 (Tomes)

Fragments, upper and lower
Frammenti di radici superiori e inferiori



2650/286

Upper roots, premolars and incisors, either side
Radici, premolari e incisivi superiori destri e sinistri



2650/65

Upper roots and fragments
Radici e frammenti superiori



2650/103

Lower incisors, premolars and roots, either side
Incisivi, premolari e radici inferiori destri e sinistri



2650/151 (Cryer)

Lower premolars, incisors, roots, universal
Premolari, incisivi e radici inferiori, universali



2650/151-A (Cryer)

Lower premolars, incisors, roots
Premolari, incisivi e radici inferiori



2650/151-AS

Lower premolars, incisors and roots
Denti premolari, denti incisivi e radici inferiori



2650/203

Lower incisors, premolars and roots, either side
Incisivi, premolari e radici inferiori destri e sinistri



2650/17

Lower molars, either side
Molari inferiori destri e sinistri



2650/15

Lower molars, either side
Molari inferiori destri e sinistri



2650/16 (Harris)

Lower molars, cow-horn beak, either side
Molari inferiori, corno di bue, destri e sinistri



2650/23

Lower molars, cow-horn beak, either side
Molari inferiori, corno di bue, destri e sinistri



2650/6

For separating lower molars
Per separare molari inferiori



2650/222

Lower wisdoms, either side
Denti giudizio inferiori destri e sinistri



2650/5 (Physick)

Lower wisdoms, either side
Denti giudizio inferiori destri e sinistri



Dr. Fabrizio Comella: since the beginning of his career, as a dentist and researcher, he has been active in the specific field of technical development applied to dental instruments and devices. He is regularly cooperating with MEDESYS since 2007 for the study and the realization of innovative instruments conceived for use in surgery and implantology.

Dr. Fabrizio Comella: sin dall'inizio della sua carriera, come dentista e ricercatore, ha sfruttato le sue competenze tecniche nello sviluppo di strumenti in ambito odontoiatrico. Collabora attivamente con MEDESYS sin dal 2007, con la quale ha realizzato innovativi strumenti nel campo della chirurgia ed implantologia.

TOOTH FORCEPS BY DR. COMELLA

PINZE PER ESTRAZIONE DEL DR. COMELLA



2400/70

(1:1 scale / scala 1:1)

DR. FABRIZIO COMELLA'S FORCEPS

Dr Comella's forceps are the only forceps specifically designed for the extraction of the root and fragments of horizontal impacted third molars. The extraction of impacted third molars deserves a special attention for its complexity. Traditional tools and especially the elevators may be very unsafe as they may cause a damage to adjacent nerves and tissues, in the worst case even to the lingual nerve. Dr. Comella's forceps offer a secure and comfortable grip for an easy handling and healthy preservation of the surrounding tissues.

(Protected by International Patent)

LA PINZA DEL DR. FABRIZIO COMELLA

La pinza del Dr. Comella è stata sviluppata specificatamente per l'estrazione delle radici e frammenti dell'ottavo incluso. Nella pratica odontoiatrica, l'estrazione di un ottavo incluso richiede una precisione assoluta, essendo di fatto un intervento tra i più delicati. Particolarità di questa pinza è la possibilità di estrarre anche le radici che risultano meno accessibili con l'ausilio di strumenti tradizionali: in particolare l'uso delle leve può provocare lacerazioni dei tessuti molli adiacenti con interessamento (nei casi più estremi) del nervo linguale. La pinza del Dr. Comella offre una presa sicura, preservando i tessuti adiacenti.

(Protetta da Brevetto Internazionale)

CLINICAL CASE: EXTRACTION OF THE HORIZONTALLY IMPACTED LOWER THIRD MOLAR

CASO CLINICO: ESTRAZIONE DEL TERZO MOLARE INFERIORE IN INCLUSIONE ORIZZONTALE



SURGICAL / CHIRURGIA

1 Full section of the crown
Sezione completa della corona



2 Access to the extraction site
Accesso al sito estrattivo



3 Grasp of the impacted tooth root
Presca radicolare dente incluso



FORCEPS "BLADE BEAKS"

- 1 "Blade Beaks" smoothly penetrate in contact with the root.
- 2 They have larger contact surface for a secure grip.
- 3 They are delicate with surrounding tissues and minimize the risk of tooth fracture.
- 4 They give better control over the root during the extraction operations.

PINZE "BLADE BEAKS"

- 1 "Blade Beaks" penetrano facilmente sino al contatto della radice.
- 2 Hanno una maggior superficie di contatto per una presa più sicura.
- 3 Assicurano un maggior rispetto dei tessuti e riducono il rischio di frattura del dente.
- 4 Danno maggior controllo sulla radice durante le fasi di estrazione.

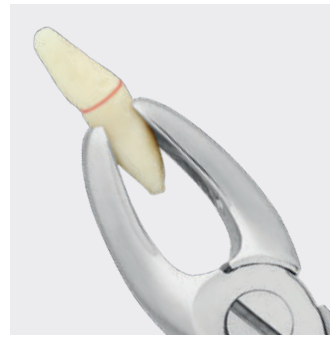
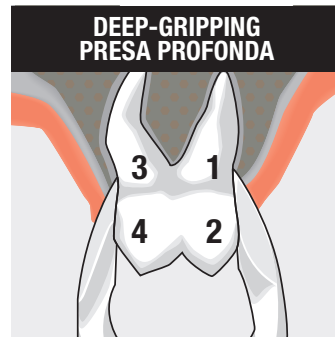

Tooth forcep English type
Pinza per estrazione forma inglese



Tooth forcep Blade beaks
Pinza per estrazione Blade beaks



2400/1
(1:1 scale / scala 1:1)



2400/1

Upper centrals and canines
Incisivi centrali e canini superiori



2400/34-N

Upper centrals and canines, narrow tips
Incisivi centrali e canini superiori, punte strette



2400/7

Upper premolars
Premolari superiori

2400/35-N
(1:1 scale / scala 1:1)



2400/35-N

Upper premolars, narrow tips
Premolari superiori, punte strette



2400/17

Upper molars, right
Molari superiori destri



2400/18

Upper molars, left
Molari superiori sinistri



SURGICAL / CHIRURGIA



2400/51
(1:1 scale / scala 1:1)

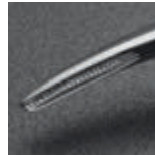

2400/51
Upper roots
Radici superiori

2400/51-AL
Upper roots
Radici superiori

2400/67
Upper third molars and upper
wisdoms either side
Terzo molare superiore e denti
del giudizio superiori

2400/67-N
Upper third molars and upper
wisdoms either side, narrow tips
Terzo molare superiore e denti
del giudizio superiori, punte strette

2400/22
(1:1 scale / scala 1:1)



2400/22
Lower molars
Molari inferiori

2400/86
Lower molars decayed
or broken down crowns
Molari inferiori scoronati

2400/74
Lower roots and incisors
Radici inferiori e incisivi

2400/13
Lower premolars either side
Premolari inferiori destri e sinistri





2400/79

Lower third molars and lower wisdoms either side
Terzo molare inferiore e denti del giudizio inferiori

2400/79-N

Lower third molars and lower wisdoms either side
Terzo molare inferiore e denti del giudizio inferiori

2400/187

Lower roots fragments
Frammenti di radici inferiori



2400/SET

Content / Contenuto:

2400/22-13-79-187-74-1-7-17-18-51

Blade beaks set, contains a selection of 10 tooth forceps.

Set Blade beaks, contiene una selezione di 10 pinze per estrazione.

“ MEDESY IN SPOT

Upon specific request, the set can be assembled with different forceps.

Su richiesta, è possibile cambiare il contenuto del set.

”

FORCEPS FOR LOWER WISDOM TEETH PINZE PER DENTI DEL GIUDIZIO INFERIORI



Both forceps are specifically projected for the extraction of lower wisdom teeth. Their special shape allows an easy and safe extraction even when the patient is unable to fully open the mouth. The forceps must be positioned between tooth # 7 and # 8. After checking if the dental arch is complete evaluate if tooth # 7 is healthy as it is often decayed. Squeeze the handles of the forceps while tilting them simultaneously, the tooth #8 will be levered out presenting the root in the distal position (as you will be able to verify through an x-ray image).

Entrambi i modelli di pinze sono ideali per l'estrazione dei denti del giudizio inferiori. La loro speciale sagoma permette di operare anche in caso di apertura limitata della bocca. La pinza si posiziona fra il 7 e 8 facendo attenzione che l'arcata sia completa ed il 7 sano (il quale spesso non è in ottime condizioni). Chiudendo ed inclinando la pinza, l'8 verrà sollevato e la radice si presenterà in posizione distale (come sarà poi possibile verificare con l'x-ray).

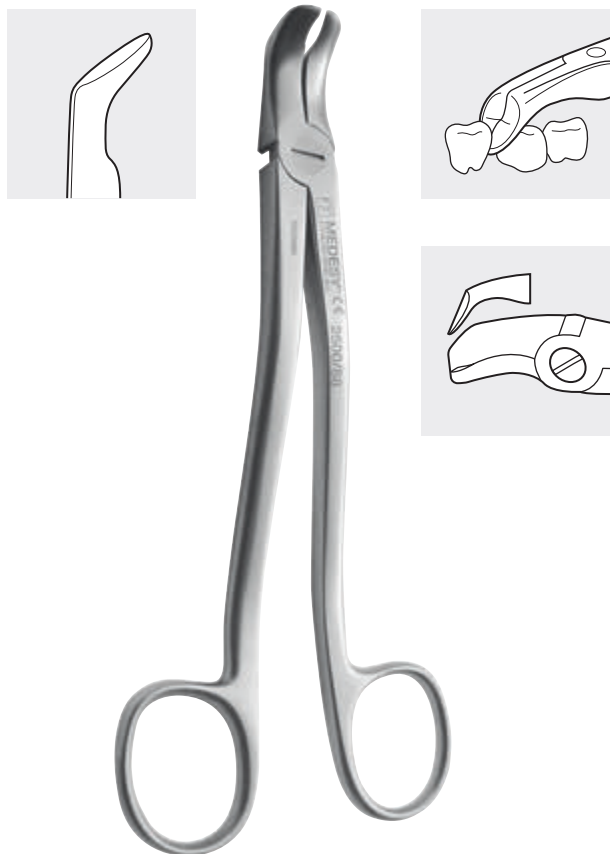

2500/88 (mm 175)



2500/98 (mm 165)





ROOT ELEVATORS

LEVE PER RADICI



680/1 Bein mm 2 Round Tonda	680/2 Bein mm 3 Round Tonda	680/3 Bein mm 4 Round Tonda	680/4 Bein mm 2 Flat Piatta	680/5 Bein mm 3 Flat Piatta	680/6 Bein mm 4 Flat Piatta
---	---	---	---	---	---



680/7 White mm 4	680/8 White mm 4 Curved Curva	680/9 Berten mm 5 Lower roots Radici inferiori	680/11 mm 3	680/12 mm 3
-------------------------------	---	--	-----------------------	-----------------------



690/3 Flohr mm 3 Left Sinistra	690/4 Flohr mm 3 Right Destra	690/7 Flohr mm 3 Flat Piatta	690/8 Flohr mm 3 Flat Piatta
--	---	--	--



680/13 mm 3 Left Sinistra	680/14 mm 3 Right Destra	690/5 Cryer Left Sinistra	690/6 Cryer Right Destra
--	---	--	---





726/1S	726/2S	726/3S	726/4S	726/5S	726/6S
mm 2	mm 2,5	mm 3	mm 3,5	mm 4	mm 4,5
Straight Retta	Straight Retta	Straight Retta	Straight Retta	Straight Retta	Straight Retta



726/SET

Contains / Contiene:
726/2S-726/3S-726/4S
726/2C-726/3C-726/4C



726/1C	726/2C	726/3C	726/4C	726/5C	726/6C
mm 2	mm 2,5	mm 3	mm 3,5	mm 4	mm 4,5
Curved Curva	Curved Curva	Curved Curva	Curved Curva	Curved Curva	Curved Curva





720/1
Apical 301
mm 2,5

720/4
Apical 304
mm 3

720/5
12 A
mm 3

720/6
Seldin 34 S
mm 4



720/15
Seldin 2 S
mm 3/6,5



720/7
Seldin
mm 5

720/8
mm 3,2

720/9
Flohr
mm 4,2

720/20
Flohr
mm 3,2

“ MEDESY IN SPOT

*All elevators points
are in scale 1:1*

*Tutte le punte delle leve
sono in scala 1:1 ”*

APEXO



720/2
Hourigan
mm 2,5
Left
Sinistra



720/3
Hourigan
mm 2,5
Right
Destra



720/10
Schmeckebier
mm 3
Left
Sinistra



720/11
Schmeckebier
mm 3
Right
Destra



720/29
Miller 1
Left
Sinistra



720/30
Miller 2
Right
Destra



720/31
Miller 3
Left
Sinistra



720/32
Miller 4
Right
Destra





Mini – 7 mm



Mini – 7 mm



Small – 9 mm



Small – 9 mm



720/25S
Cryer

Left
Sinistra

720/26S
Cryer

Right
Destra

720/25
Cryer

Left
Sinistra

720/26
Cryer

Right
Destra

Medium – 12 mm



Medium – 12 mm



Large – 15 mm



Large – 15 mm



720/27S
Cryer

Left
Sinistra

720/28S
Cryer

Right
Destra

720/27
Cryer

Left
Sinistra

720/28
Cryer

Right
Destra



720/21
Seldin

Left
Sinistra

720/22
Seldin

Right
Destra

720/23
Seldin

Left
Sinistra

720/24
Seldin

Right
Destra



790/1

Left
Sinistra

790/2

Right
Destra



780/1 W. Barry	780/2 W. Barry	780/3 W. Barry	780/4 W. Barry
Left Sinistra	Right Destra	Left Sinistra	Right Destra



“ MEDESY IN SPOT
The right way to hold the Winters and Barry elevators, for a perfect use.
La giusta impugnatura delle Winters e Barry, per un utilizzo perfetto.
”



785/1L Winter	785/1R Winter	785/11L Winter	785/11R Winter	785/12L Winter	785/12R Winter
Left Sinistra	Right Destra	Left Sinistra	Right Destra	Left Sinistra	Right Destra



799/2
Medan-Bein
mm 2,5



799/3
Medan-Bein
mm 3
Flat
Piatta



799/5
Medan-Bein
mm 3
Round
Tonda



799/6
Medan-Bein
mm 4
Pointed
Appuntita



799/7
Medan-Flohr
mm 3
Left
Sinistra



799/8
Medan-Flohr
mm 3
Right
Destra



799/9
Medan-Cryer
Left
Sinistra



799/10
Medan-Cryer
Right
Destra



795/1
Hyllin
mm 3



795/2
Hyllin
mm 4



795/5
Hyllin
mm 4
Flat
Piatta



795/3
Hyllin
mm 3
Left
Sinistra



795/4
Hyllin
mm 3
Right
Destra



728/1
Friedman
mm 4
Mesial
Mesiale



728/2
Friedman
mm 4
Distal
Distale





740/1
Anatomic
mm 3

740/2
Anatomic
mm 3
Flat
Piatta

740/3
Anatomic
mm 4



740/4
Anatomic
mm 3
Left
Sinistra

740/5
Anatomic
mm 3
Right
Destra



“ MEDESY IN SPOT

The Anatomic handle is the most ergonomic among our elevators' line.

Il manico Anatomic è il più ergonomico tra la nostra linea di leve.

”



797/1
London Hospital
mm 5

797/4
London Hospital
mm 5
Flat
Piatta



797/2
London Hospital
mm 4
Left
Sinistra

797/3
London Hospital
mm 4
Right
Destra



798/1
Coupland
mm 3

798/2
Coupland
mm 3,6

798/3
Coupland
mm 4,2





800/1
KOPP
mm 3,6



800/2
KOPP
mm 3,6



800/3
KOPP
mm 4,2



800/4
KOPP
mm 4,2



800/5
KOPP
mm 4,2
Left
Sinistra

800/6
KOPP
mm 4,2
Right
Destra

ROOT ELEVATORS "KOPP"

A distinct elevator having a sharp edged helical groove on the tip ensuring an easier penetration between the tooth and the alveolus. A safe and fast extraction of the root is obtained through moderate pressure and smooth rotation of the elevator. Available in 2 sizes, the small 3,6 mm and the large 4,2 mm.

LEVE PER RADICI "KOPP"

Si distinguono facilmente grazie alla forma elicoidale delle punte e zigrinatura interna. La penetrazione della punta tra dente ed alveolo risulterà facilitata, a tutto vantaggio di una estrazione sicura e veloce. Di fatto, con una moderata pressione e rotazione della leva stessa, la radice sarà estratta agevolmente. Disponibile in 2 misure, la piccola di 3,6 mm e la grande di 4,2 mm.

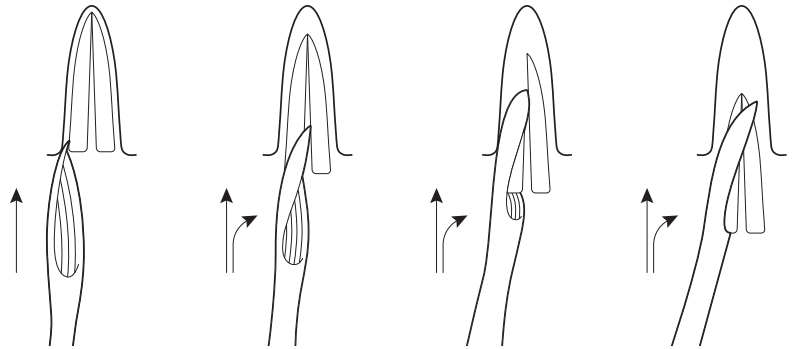



700/1 mm 2,0	700/2 mm 2,5	700/3 mm 3,0 Offset Baionetta
------------------------	------------------------	---



750/1 POTT mm 3 Left Sinistra	750/2 POTT mm 3 Right Destra
--	---



796/1 Warwick-James mm 2,2	796/2 Warwick-James mm 2,2 Left Sinistra	796/3 Warwick-James mm 2,2 Right Destra
---	---	--



ROOT ELEVATORS APEXO

LEVE PER RADICI APEXO

730/301

(1:1 scale / scala 1:1)

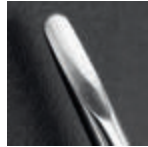

730/301

Apexo
mm 2,5 × 9,0

Straight
Retta

730/302

Apexo
mm 2,7 × 9,0

Straight
Retta

730/303

Apexo
mm 3,0 × 9,0

Straight
Retta

730/304W

Apexo
mm 3,0 × 14,0

Straight
Retta

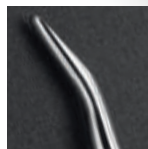

730/302CB

Apexo
mm 2,5 × 9,0

Curved
Curva

730/303CB

Apexo
mm 3,0 × 9,0

Curved
Curva

735/SET

APEXO

Content / Contenuto:

730/301-302-303-304W-302CB-303CB

ROOT ELEVATORS LUSSATORE

LEVE PER RADICI LUSSATORE



730/4S
(1:1 scale / scala 1:1)



730/3S
Lussatore
mm 3
Straight
Retta

730/3C
Lussatore
mm 3
Curved
Curva

730/4S
Lussatore
mm 4
Straight
Retta

730/4C
Lussatore
mm 4
Curved
Curva

730/5S
Lussatore
mm 5
Straight
Retta

730/5C
Lussatore
mm 5
Curved
Curva

Lussatore elevators have extremely thin and sharp blade and better fit in tight apical spaces, as well as more efficient at cutting the periodontal ligament. The special shape ensures an easy widening of the alveolus, in many cases making the use of extraction forceps needless.

Leva che possiede una lama estremamente piatta e tagliente, permette una precisa penetrazione e taglio del ligamento periodontale. Il vantaggio del Lussatore risiede nella diminuzione dei traumi esercitati sui denti e gengive ed in molti casi esclude la necessità dell'uso delle tenaglie per estrazione.

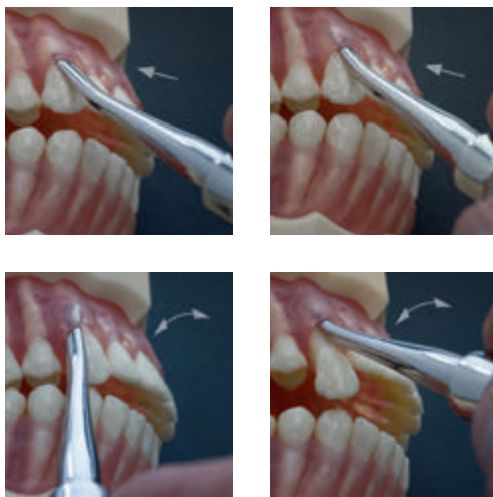

730/SET
LUSSATORE

Content / Contenuto:
730/3S-3C-4S-4C-5S-5C



ROOT ELEVATORS LINDO LEVIAN

LEVE PER RADICI LINDO LEVIAN

725/1
(1:1 scale / scala 1:1)

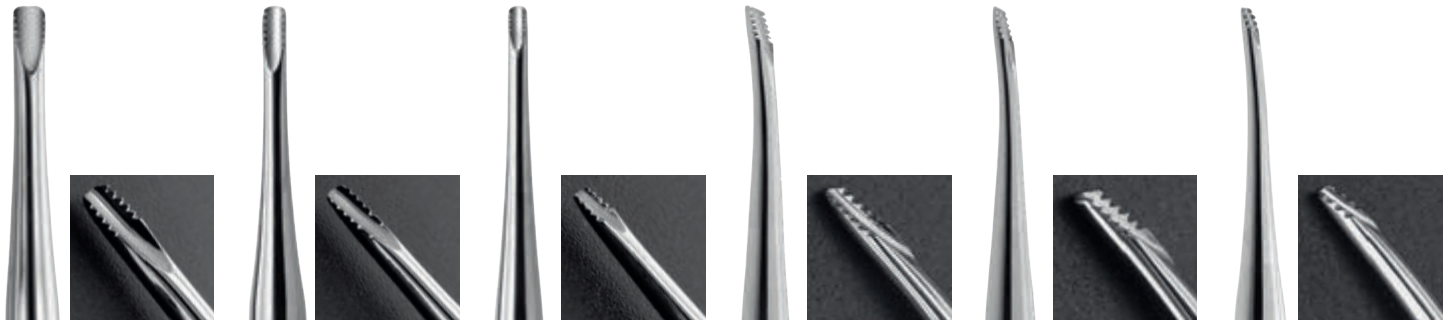

725/1
Lindo Levian
mm 4 × 8
Straight
Retta

725/2
Lindo Levian
mm 3 × 8
Straight
Retta

725/3
Lindo Levian
mm 2,5 × 5
Straight
Retta

725/4
Lindo Levian
mm 4 × 8
Curved
Curvo

725/5
Lindo Levian
mm 3 × 8
Curved
Curvo

725/6
Lindo Levian
mm 2,5 × 5
Curved
Curvo

SERRATED TIPS PUNTE ZIGRINATE



Thanks to the serrated tips, elevators **LINDO LEVIAN** ensure a smooth extraction of the root and eliminate the need of any leverage procedure. A slight rotary movement of the tip, positioned between the alveolus and the root will produce an easy extraction.

Grazie alle punte zigrinate, con le leve **LINDO LEVIAN** si può ottenere l'estrazione della radice escludendo il classico effetto leva. Una volta inserita la punta in posizione, per mezzo di un delicato movimento rotatorio si potrà estrarre la radice.



725/SET LINDO LEVIAN

Content / Contenuto:

725/1-725/2-725/3-725/4-725/5-725/6

LUSSATORE LEVER FOR UPPER WISDOM TEETH

LEVA D'ESTRAZIONE PER IL DENTE DEL GIUDIZIO SUPERIORE



The luxating elevator is inserted vertically between the third molar and the second molar firmly pressed up to the level of the gingival tissue.

La leva viene inserita verticalmente tra il terzo e secondo molare, premendo fermamente sino alla gengiva.



The third molar is pulled out from the alveolus on its distal axis by rotating the luxating elevator.

Il terzo molare sarà estratto dall'alveolo in direzione distale rispetto il proprio asse, attraverso una leggera rotazione della leva.

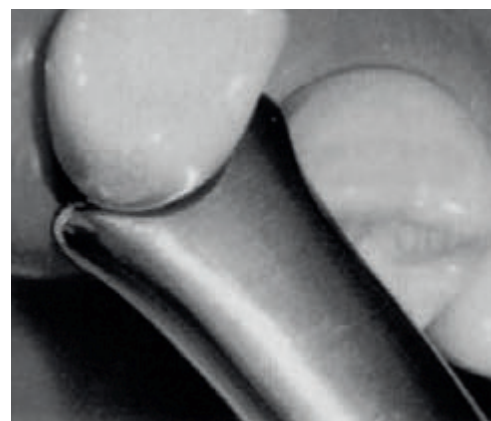
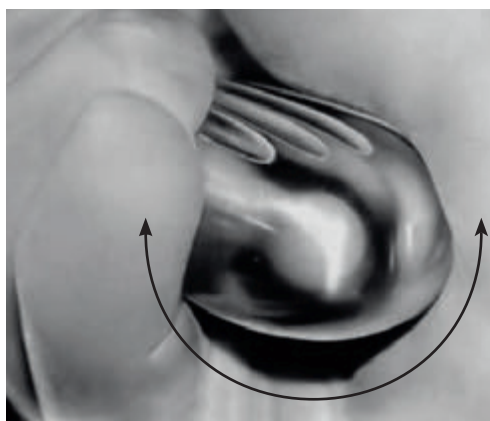

The instrument must be used only by exploiting the rotating force in distal direction.

IMPORTANT: never use the second molar as a lever point for the instrument during the luxation.

Lo strumento deve essere usato con forza di rotazione in direzione distale.

IMPORTANTE: non considerare il secondo molare come punto di appoggio durante la lussazione.

727/50

(1:1 scale / scala 1:1)



SURGICAL / CHIRURGIA

FRAGMENT ELEVATORS

LEVE PER FRAMMENTI



ø mm 1,5



ø mm 2,5



705/7

Heidbrink ø 1,5

Left
Sinistra

705/8

Heidbrink ø 1,5

705/9

Heidbrink ø 1,5

Right
Destra

705/1

Heidbrink ø 2,5

Left
Sinistra

705/2

Heidbrink ø 2,5

705/3

Heidbrink ø 2,5

Right
Destra

705/4

Heidbrink Apical
ø mm 1,5

10 mm hollow handle
10 mm manico vuoto

705/6

Howard Apical
ø mm 2,5

10 mm hollow handle
10 mm manico vuoto



700/11

Heidbrink ø 2,5

Left
Sinistra

700/12

Heidbrink ø 2,5

700/13

Heidbrink ø 2,5

Right
Destra



700/9

Heidbrink ø 2,0

Left
Sinistra

700/8

Heidbrink ø 2,0

700/10

Heidbrink ø 2,0

Right
Destra

EXTRACTORS FOR ROOT FRAGMENTS

ESTRATTORI PER FRAMMENTI



7500/20

mm 34
Short
Corto

7500/22

mm 44
Long
Lungo

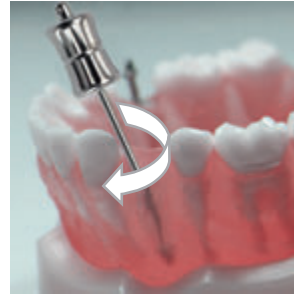
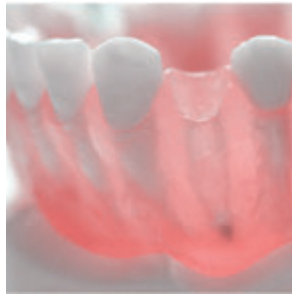

Manual root extractors for root fragments.
Estrattori manuali per frammenti.

CLINICAL CASE: EXTRACTION OF THE TOOTH 44 (INFERIOR PREMOLAR)

CASO CLINICO: ESTRAZIONE DEL DENTE 44 (PREMOLARE INFERIORE)



1

For security reasons ligate the extractor with floss.

Per motivi di sicurezza legare l'estrattore al filo.

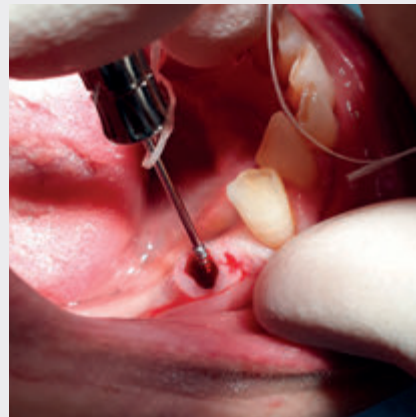

2

Screw clockwise the extractor into the root fragment.

Avvitare in senso orario lo strumento nel residuo.



3

Gently extract from the alveolus.

Estrarre delicatamente dall'alveolo



4

The fragment is easily extracted.

Il frammento è facilmente estratto



SURGICAL / CHIRURGIA

810/2Ti
(1:1 scale / scala 1:1)

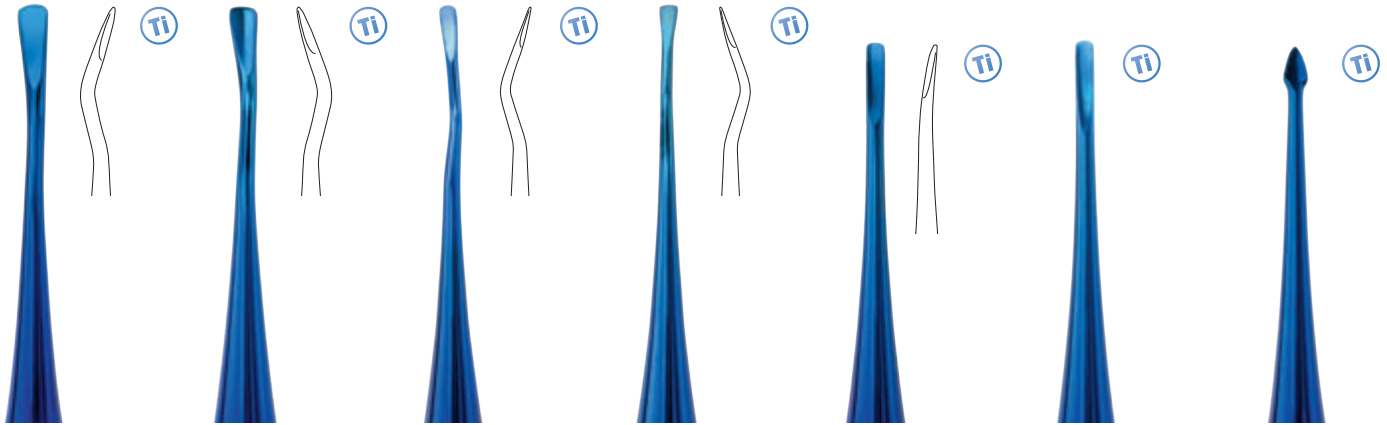

810/1Ti

mm 4
Distal
Distale

810/2Ti

mm 4
Mesial
Mesiale

810/3Ti

mm 2,5
Distal
Distale

810/4Ti

mm 2,5
Mesial
Mesiale

810/5Ti

mm 2,5
Curved
Curva

810/6Ti

mm 2,5
Straight
Retta

810/7Ti

mm 3,4
Straight
Retta

MIDELUX minute elevators available in 3 different sizes.

A specific distal and mesial shape ensures an easy as well as rapid loosening of a tooth. The smaller size for standard general use while the 4 mm tips specific for loosening molar teeth. The set is completed by a special elevator having an arrow-shaped tip for detaching desmodontal fibres. All tips are in stainless steel and blue titanium coated.

MIDELUX, mini leve disponibili in 3 differenti forme. La lussazione risulterà facile e veloce grazie alla speciale forma sviluppata, mesiale e distale. La punta sottile risulta ideale per un utilizzo generico, mentre la punta larga da 4 mm è appositamente studiata per i molari. Il set si completa con una speciale punta a freccia per rimuovere tessuti. Gli strumenti hanno le punte in acciaio anodizzato con titanio.



810/KIT

Content / Contenuto:
810/1Ti-2Ti-3Ti-4Ti-5Ti-6Ti-7Ti
on Gammafix tray 980/10



ROOT ELEVATORS *MEDIMPLA*

LEVE PER RADICI *MEDIMPLA*



812/3Ti
(1:1 scale / scala 1:1)

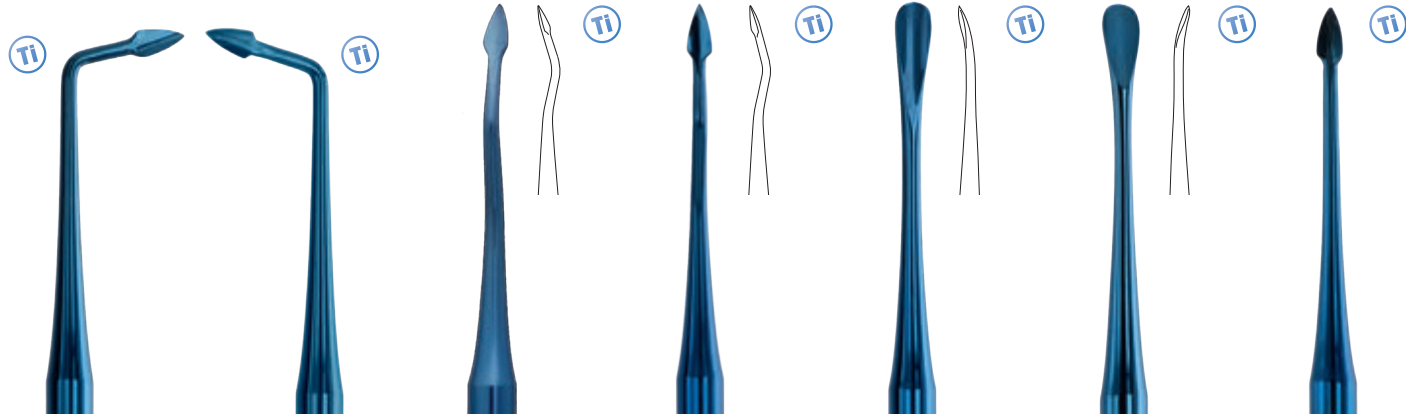

812/1Ti	812/2Ti	812/3Ti	812/4Ti	812/5Ti	812/6Ti	812/7Ti
mm 3,4	mm 3,4	mm 3,4	mm 3,4	mm 4,5	mm 4,5	mm 3,4
Left Sinistra	Right Destra	Mesial Mesiale	Distal Distale	Distal Distale	Mesial Mesiale	Straight Retta

The insertion of the new *MEDIMPLA* root elevators into the intraligamental zone is easier thanks to the extreme sharpness and perfect bending of the tip. These elevators have been conceived to perform a minimum traumatic extraction and therefore to preserve the alveolar site in perfect conditions. The special "pen form" assures very delicate movements. All the tips are in stainless steel and blue titanium coated.

L'inserimento della leva *MEDIMPLA* nel sito intraligamentale risulterà facilitato grazie ad una estrema finezza e particolare curvatura di questa nuova linea di mini leve. Tutto ciò al fine di garantire un'estrazione più atraumatica possibile, che permette quindi di conservare il sito alveolare in perfette condizioni. La speciale forma "a penna" assicura movimenti particolarmente delicati. Gli strumenti hanno le punte in acciaio anodizzato con titanio.

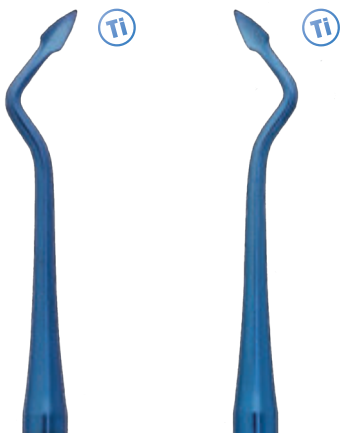

812/8Ti	812/9Ti
mm 3,4	mm 3,4
Left Sinistra	Right Destra



812/KIT
Content / Contenuto:
812/1Ti-2Ti-3Ti-4Ti-5Ti-6Ti-7Ti
on Gammaxif tray 980/10



SURGICAL / CHIRURGIA



684/SET

Set root elevators
Set leve

Content / Contenuto:

- 680/1
- 680/2
- 680/3
- 690/3
- 690/4
- 690/5
- 690/6
- 700/8
- 700/9
- 700/10
- 852/HP3



686/SET

Set root elevators
Set leve

Content / Contenuto:

- 795/1
- 795/2
- 795/3
- 796/1
- 796/2
- 796/3
- 798/1
- 798/2
- 798/3

680/SET

Set root elevators
Set leve

Content / Contenuto:

720/27
720/28
726/1S
726/2S
726/3S
726/4S
726/5S
726/6S
800/5
800/6
2164



682/SET

Set root elevators
Set leve

Content / Contenuto:

720/9
720/10
720/11
785/12R
785/12L



SURGICAL / CHIRURGIA

SYNDESMOTOMES SINDESMOTOMI



1655/1 RS

1655/2 CB

Straight
Retto

Curved
Curvo



1650/1

Chompret N. 1

1650/2

Chompret N. 2

1650/3

Chompret N. 3
Faucille

1650/4

Chompret N. 4
Faucille

PERIOSTEALS SCOLLAPERIOSTEI



880
Williger
mm 155
Round
Tondo

881
Williger
mm 155
Pointed
Appuntito



876/22
Seldin

876/23
Seldin

874/P1
Hopkins

874/P2
Hopkins

875/12 S
Bennett

SYNDESMOTOMES SINDESMOTOMI

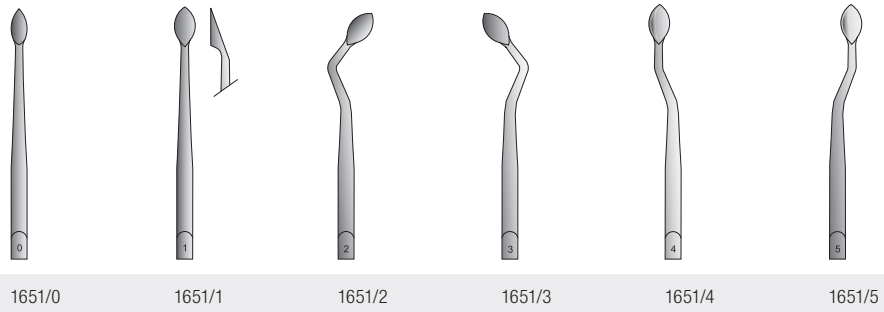

1651/0 1651/1 1651/2 1651/3 1651/4 1651/5

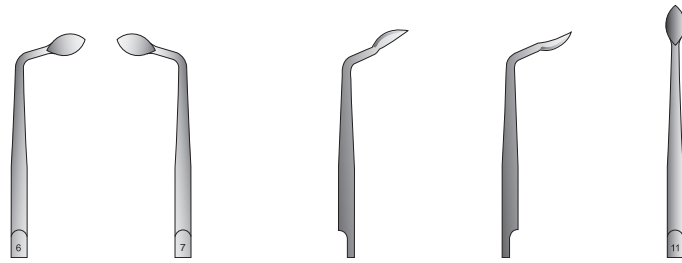

1651/6 1651/7 1651/8 1651/9 1651/11

1651/OTT
mm 115

Octagonal handle
Manico ottagonale

1651/MN
mm 115

Flat handle
Manico piatto

1651/VS

Syndesmotome tips holder, aluminium
Porta punte sindesmotomo, alluminio

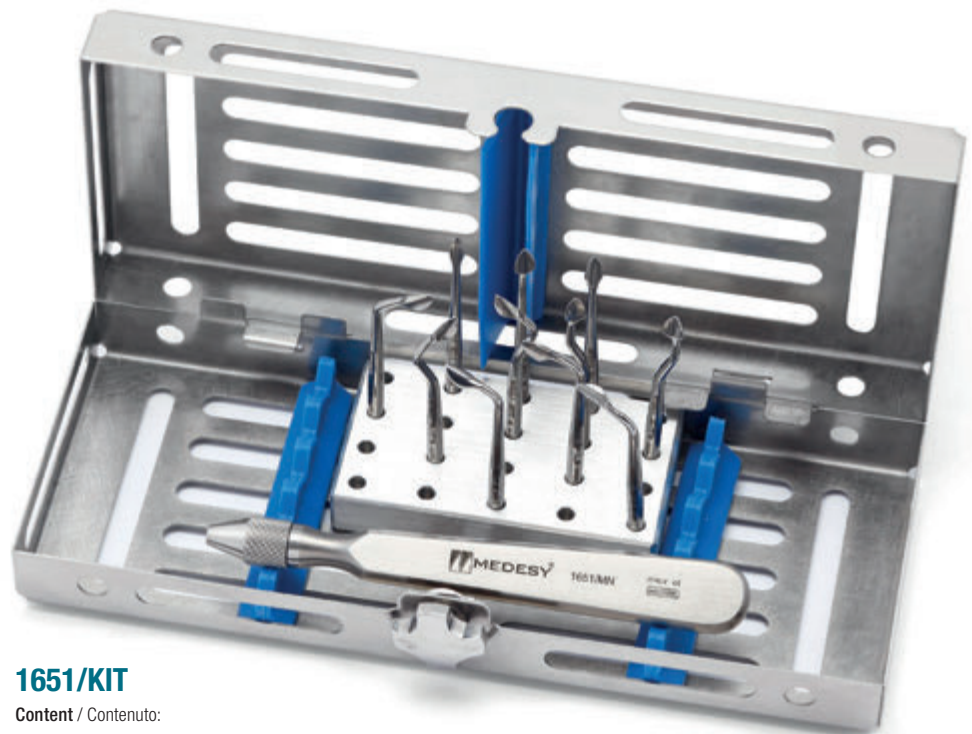

1651/KIT

Content / Contenuto:
1651/MN
1651/VS
11 tips
978 Gammaxfix tray UN



SURGICAL / CHIRURGIA

852/HP3

(1:1 scale / scala 1:1)



851/HP3

3 mm

3 mm

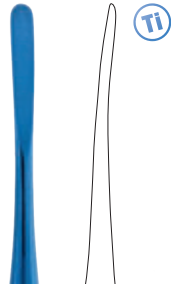

851/HP3 Ti

3 mm

3 mm



852/HP3

5,2 mm

4,8 mm



883

Molt
3,8 mm

4 mm



872/P14

Goldman-Fox
4,5 mm

5,5 mm

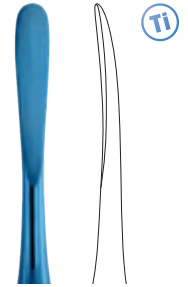

872/P14 Ti

Goldman-Fox
4,5 mm

5,5 mm



854/H02

7 mm

5 mm

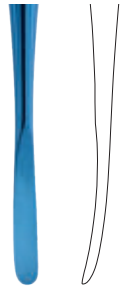

854/H02 Ti

7 mm

5 mm



856

Medesy
3,3 mm

2,8 mm



871/2-4

Molt
6 mm

2,7 mm



871/2-4 Ti

Molt
6 mm

2,7 mm

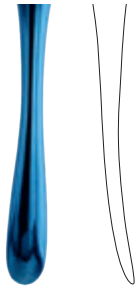

884

Freer
4 mm

4 mm



854/H02

7 mm

5 mm

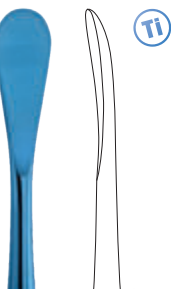

854/H02 Ti

7 mm

5 mm



856

Medesy
3,3 mm

2,8 mm



871/2-4

Molt
6 mm

2,7 mm

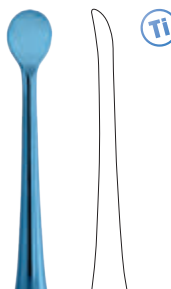

871/2-4 Ti

Molt
6 mm

2,7 mm



884

Freer
4 mm

4 mm



854/H02

7 mm

5 mm

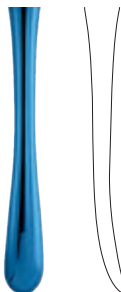

854/H02 Ti

7 mm

5 mm



856

Medesy
3,3 mm

2,8 mm



871/2-4

Molt
6 mm

2,7 mm

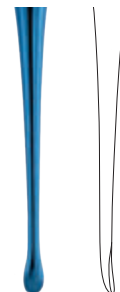

871/2-4 Ti

Molt
6 mm

2,7 mm



884

Freer
4 mm

4 mm

877/HK4 Ti
(1:1 scale / scala 1:1)



885
Freer
4,5 mm

5 mm



878
Prichard
10 mm

4,5 mm

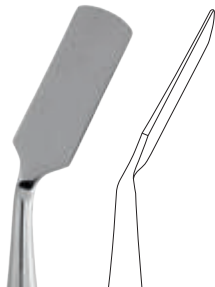

850

8 mm

8 mm



877/HK4
24 G
4 mm

4 mm

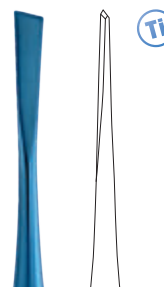

877/HK4 Ti
24 G
4 mm

4 mm



879
Mead
7 mm

7 mm



870
Howard
7,5 mm

7,5 mm



882
Molt N. 9
4 mm

7 mm

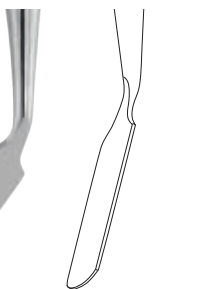

882/Ti
Molt N. 9
4 mm

7 mm



869
Allen
3,5 mm

8 mm

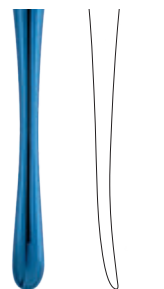

873/PH2
Hourigan
4 mm

3 mm



879
Mead
7 mm

7 mm



870
Howard
7,5 mm

7,5 mm



882
Molt N. 9
4 mm

7 mm

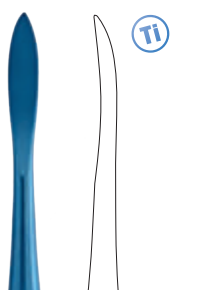

882/Ti
Molt N. 9
4 mm

7 mm



869
Allen
3,5 mm

8 mm

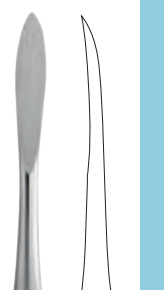

873/PH2
Hourigan
4 mm

3 mm

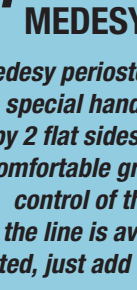

879
Mead
7 mm

7 mm



870
Howard
7,5 mm

7,5 mm



882
Molt N. 9
4 mm

7 mm



882/Ti
Molt N. 9
4 mm

7 mm



869
Allen
3,5 mm

8 mm

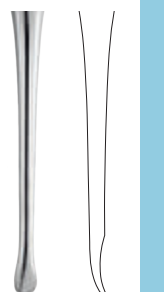

873/PH2
Hourigan
4 mm

3 mm

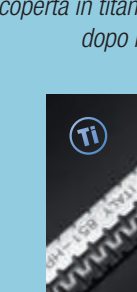

879
Mead
7 mm

7 mm

“ MEDESYS IN SPOT

Medesy periosteal elevators have a special handle characterized by 2 flat sides, ensuring more comfortable grip and maximum control of the instrument. All the line is available in titanium coated, just add “Ti” after the code.

Scollaperiosteali in manico pieno, con 2 parti piatte, lunghezza 170 mm. A vantaggio dell'utilizzatore per una miglior percezione e presa dello strumento. Tutta la linea è disponibile ricoperta in titanio, aggiungere “Ti” dopo il codice.

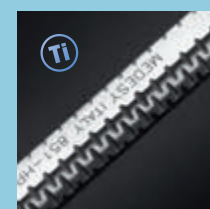

PERIOTOME

Handle with 4 interchangeable blades, for atraumatic extraction of teeth with minimal damage to the surrounding alveolar bone. Thanks to the sharp and delicate blades, the marginal gingiva and periodontal ligament can be carefully detached. Its use is particularly important when considering dental implants. PERIOTOME IS USED FOR CUTTING, NOT FOR LEVERING.

PERIOTOMO

Strumento con 4 lame intercambiabili, indirizzato alla fase di estrazione del dente senza compromettere o danneggiare il sito alveolare. Grazie alle lame efficacemente affilate e delicate, il taglio di gengiva e legamento parodontale risulterà semplice e sicuro. Il suo utilizzo è particolarmente indicato in tema di impianti dentali. IL PERIOTOMO È UNO STRUMENTO DA TAGLIO, NON UNA LEVA.

868/KIT

Handle with 4 blades
Manico con 4 lame



(1:1 scale / scala 1:1)



868/1



868/2



868/3



868/4



SCALPEL HANDLES

MANICI PER BISTURI



3629
Bad Parker
mm 125
Millimetered
Millimetrata

3633
N. 3
mm 125

3630
N. 7
mm 165

3631
mm 145

3632
mm 145
Curved
Curvo

3632/A
mm 145
Angled
Angolare

3634
N. 4
mm 140
For blades N. 4 only
Solo per lame N. 4

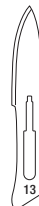

3635/10

3635/11

3635/12

3635/12D

3635/13

3635/15

3635/15C

Steril scalpel blades N.3 in package of 100 pcs
Lame per bisturi sterili N.3 in confezioni da 100 pz



SURGICAL / CHIRURGIA

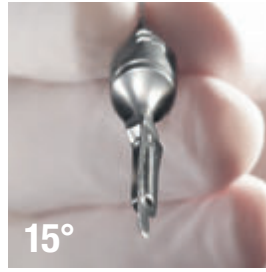
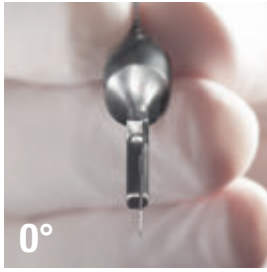

3640/1
Medesy
mm 145

3640/2
Medesy
mm 145
Angled 15°
Angolare 15°

3640/3
Medesy
mm 145
Angled 30°
Angolare 30°



3637/11
mm 110
Short handle
Manico corto

3637/16
mm 160
Long handle
Manico lungo

New scalpel handle adjustable in 7 positions and 180°
Nuovo manico per bisturi orientabile su 7 posizioni e 180°

SCALPEL HANDLES FOR MICROBLADES

MANICI PER MICROLAME



3638

mm 135



3638/Ti

mm 135
Titanium
Titanio



3638/64



3638/65



3638/67



3638/69

Microblades in package of 25 pcs
Microlame in scatole da 25 pz

BLADE REMOVER

PINZE TOGLILAMA



3636

mm 160

Scalpel blades remover
Pinza rimuovi lame



EXAMPLE OF APPLICATION

- 1 Blade to be seized here;
- 2 Then lift it here;
- 3 Finally pull it off in forward direction.

MODO DI IMPIEGO

- 1 La lama presa in questa posizione;
- 2 Inserire la punta fra il manico e la lama;
- 3 Sollevare e quindi spingere verso l'alto.

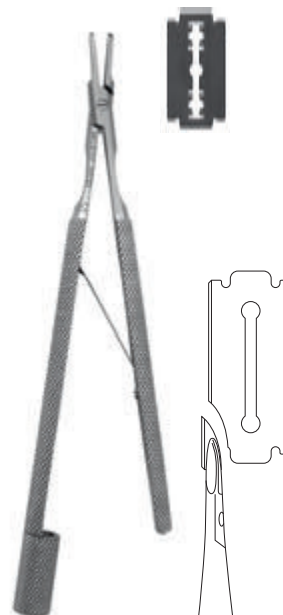

3639

mm 125

Razor blade breaker and holder
Pinza rompi e porta lame



SURGICAL / CHIRURGIA

(1:1 scale / scala 1:1)

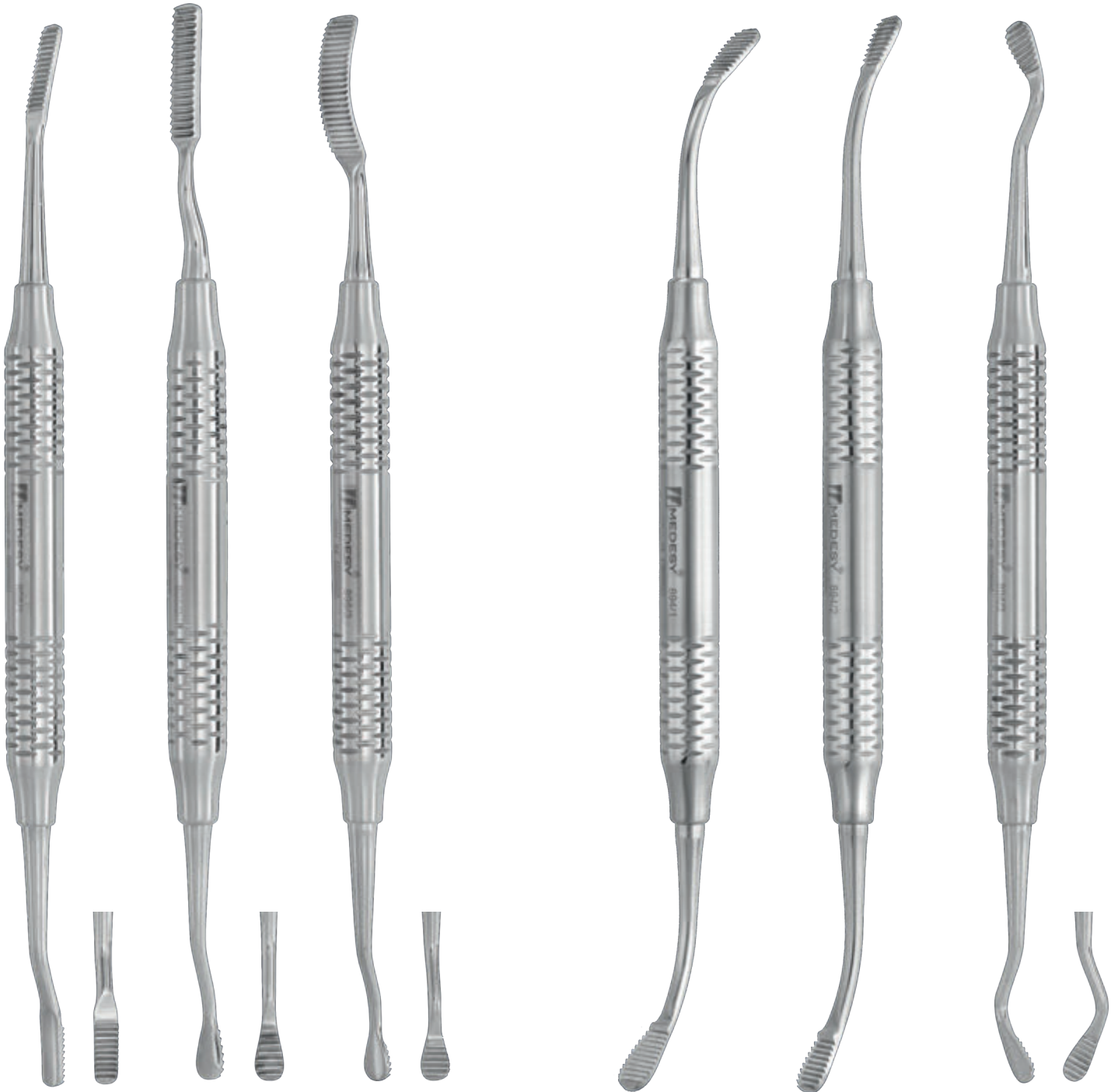

895/1

895/2

Miller N. 2

895/3

Miller N. 3

894/1

Wahl N. 1

894/2

Wahl N. 2

894/3

Howard



Single cut.
Taglio singolo.

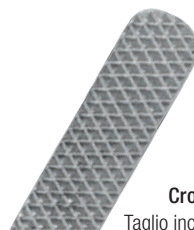

Cross cut.
Taglio incrociato.

(1:1 scale / scala 1:1)



898/1
Miller N. 4



898/3
Miller-Colburn N. 3
Cross cut
Taglio incrociato



898/2



898/4
Miller-Colburn N. 4
Cross cut
Taglio incrociato



898/5
Miller-Colburn N. 5
Cross cut
Taglio incrociato





3801
Blumenthal
mm 155



3802
Blumenthal 45°
mm 150



3803
Blumenthal 90°
mm 140



3804
Micro Luer
mm 150



3805
Luer
mm 150



3812
Kerrison



3807
Friedman
mm 140



3809
Micro Friedman
mm 145



3810
Micro Friedman 90°
mm 145



3811
Lempert Delicate
mm 160



3808
Cleveland
mm 155



3806
Beyer
mm 170



BONE CURETTES CUCCHIAI ALVEOLARI

660/4

(1:1 scale / scala 1:1)



660/0
660/0.HL8
660/0.HL10
Hemingway N.0

660/1
660/1.HL8
660/1.HL10
Hemingway N.1

660/2
660/2.HL8
660/2.HL10
Hemingway N.2

660/3
660/3.HL8
660/3.HL10
Hemingway N.3

660/4
660/4.HL8
660/4.HL10
Hemingway N.4



(1:1 scale / scala 1:1)

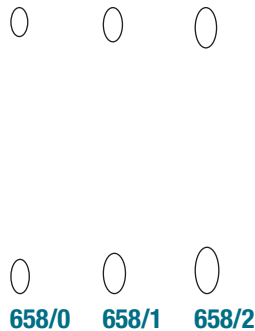

658 (mm 150)
Williger

(1:1 scale / scala 1:1)

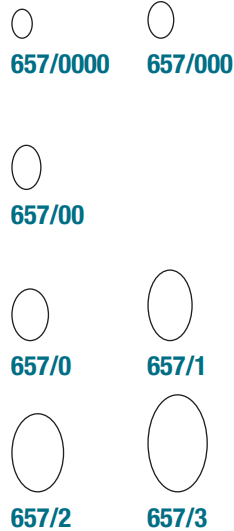

657/1 (mm 170)
Volkman

“ MEDESY IN SPOT

*Bone curette Hemingway and Lucas are available also with blue titanium coated tip, all sizes, just add **Ti** to the standard code to order the item in the titanium finish.*

*Cucchiai alveolari Hemingway e Lucas sono disponibili in tutte le misure con la punta anodizzata al Titanio blu, aggiungere **Ti** dopo il codice.*

(Es. 660/2.HL8 > 660/2-Ti.HL8)

”



(1:1 scale / scala 1:1)

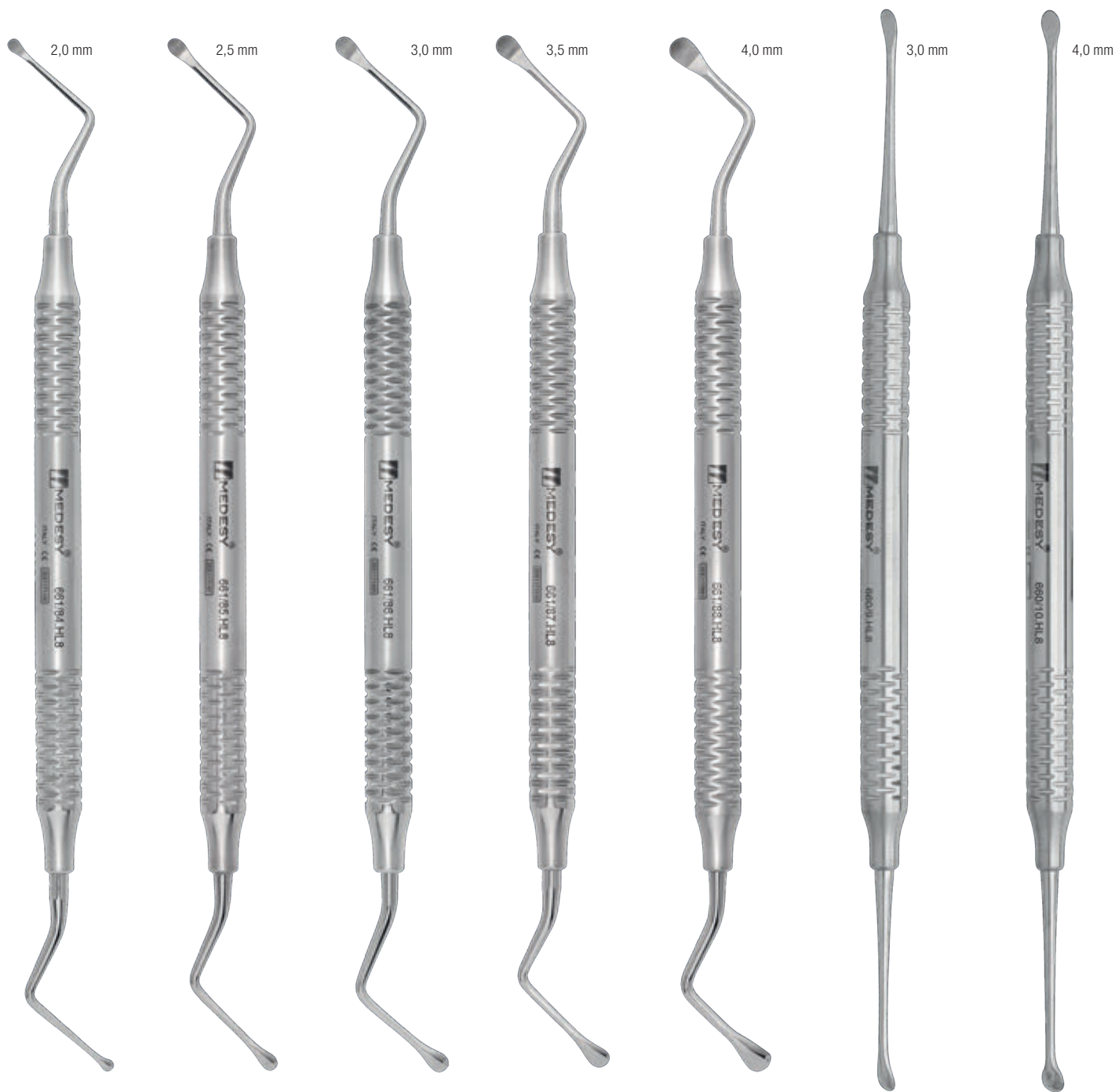

661/84
661/84.HL8
661/84.HL10
 Lucas N. 84

661/85
661/85.HL8
661/85.HL10
 Lucas N. 85

661/86
661/86.HL8
661/86.HL10
 Lucas N. 86

661/87
661/87.HL8
661/87.HL10
 Lucas N. 87

661/88
661/88.HL8
661/88.HL10
 Lucas N. 88

660/9
660/9.HL8
 Miller N.0
 Spoon shape

660/10
660/10.HL8
 Miller N.1
 Spoon shape





SURGICAL SCISSORS, HI-TECH

FORBICI CHIRURGICHE, HI-TECH



New surgical scissors HI-TECH, innovative and absolutely unique as they are entirely laser cut from stainless steel sheets instead of using classic hot forging processes.

The laser cutting technique ensures a constant and higher quality standard as well as perfect geometrical uniformity on each item.

The main features of the HI-TECH scissors are:

- Elevated hardness degree (56 HRC);
- Shape and size uniformity and accuracy;
- Assembly on elastic bases for a constant and smoother action.

Nuove forbici chirurgiche HI-TECH, innovative ed uniche nel loro genere in quanto ricavate da fogli di acciaio tagliati a laser anziché da metodo classico mediante forgiatura a caldo. Tale sistema di produzione assicura elevati standard qualitativi e geometrie perfette. Le principali caratteristiche che contraddistinguono le forbici HI-TECH sono:

- Elevata durezza (56 HRC);
- Garanzia di forma e misure;
- Assemblaggio su basi elastiche per costante scorrevolezza.



Watch the video!
Guarda il video!



3585 (mm 115)
Medesy Hi-Tech
Straight
Retta

3586 (mm 115)
Medesy Hi-Tech
Curved
Curva



3587 (mm 130)
Medesy Hi-Tech
Straight
Retta

3588 (mm 130)
Medesy Hi-Tech
Curved
Curva

3589 (mm 160)
Medesy Hi-Tech
Straight
Retta

3591 (mm 160)
Medesy Hi-Tech
Curved
Curva



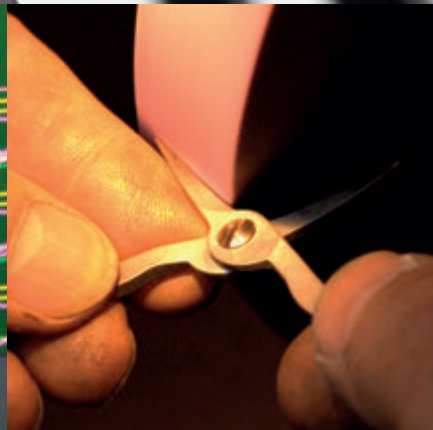
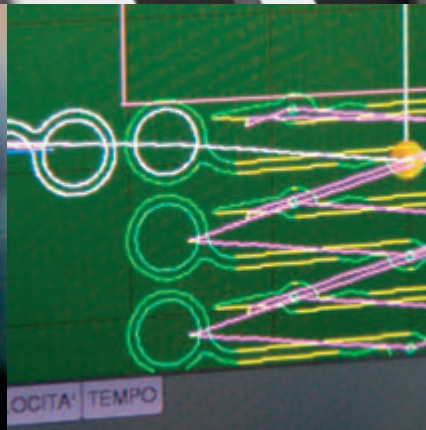

SURGICAL SCISSORS, HI-TECH

FORBICI CHIRURGICHE, HI-TECH



Medesy HI-TECH scissors are available also in the BLK variant: a special surface Diamond Like Carbon Coating, otherwise referred to as DLC coating which enables the following features:

- Prolonged edge sharpness;
- Cutting smoothness;
- High surface micro hardness (2000 HV);
- Stronger corrosion resistance;
- Reduction of light reflect.

Le forbici HI-TECH sono prodotte anche nella variante BLK: uno speciale trattamento superficiale (DLC = Diamond Like Carbon) che consente di ottenere le seguenti peculiarità:

- Affilatura prolungata;
- Fluidità di taglio;
- Microdurezza superficiale elevata (2000 HV);
- Maggiore resistenza alla corrosione;
- Superficie antibatterica;
- Riduzione della luce riflessa.



3585/BLK (mm 115)
Medesy Hi-Tech
Straight
Retta



3586/BLK (mm 115)
Medesy Hi-Tech
Curved
Curva



3587/BLK (mm 130)
Medesy Hi-Tech
Straight
Retta



3588/BLK (mm 130)
Medesy Hi-Tech
Curved
Curva



3589/BLK (mm 160)
Medesy Hi-Tech
Straight
Retta



3591/BLK (mm 160)
Medesy Hi-Tech
Curved
Curva



IRIS type, the most versatile and popular among surgical scissors, available also as Micro 90 mm variant, ideal for an accurate as well as delicate dissection of fine tissue.

Forbici serie IRIS, le più versatili e diffuse tra le forbici chirurgiche, disponibili anche nella versione Micro da 90 mm per un preciso e delicato utilizzo.



3511/90 (mm 90)
Medesy micro Iris
Straight
Retta



3511 (mm 115)
Iris
Straight
Retta



3513 (mm 120)
Iris
Angular 45°
Angolare 45°

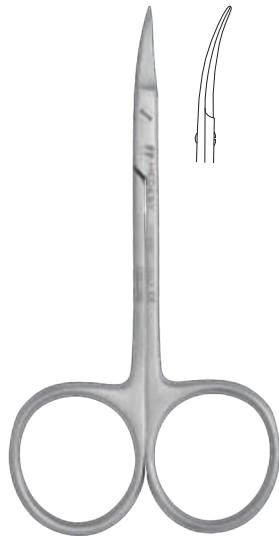

3512/90 (mm 90)
Medesy Micro Iris
Curved
Curva



3512 (mm 115)
Iris
Curved
Curva



3505 (mm 115)
Sickle
Curved
Curva

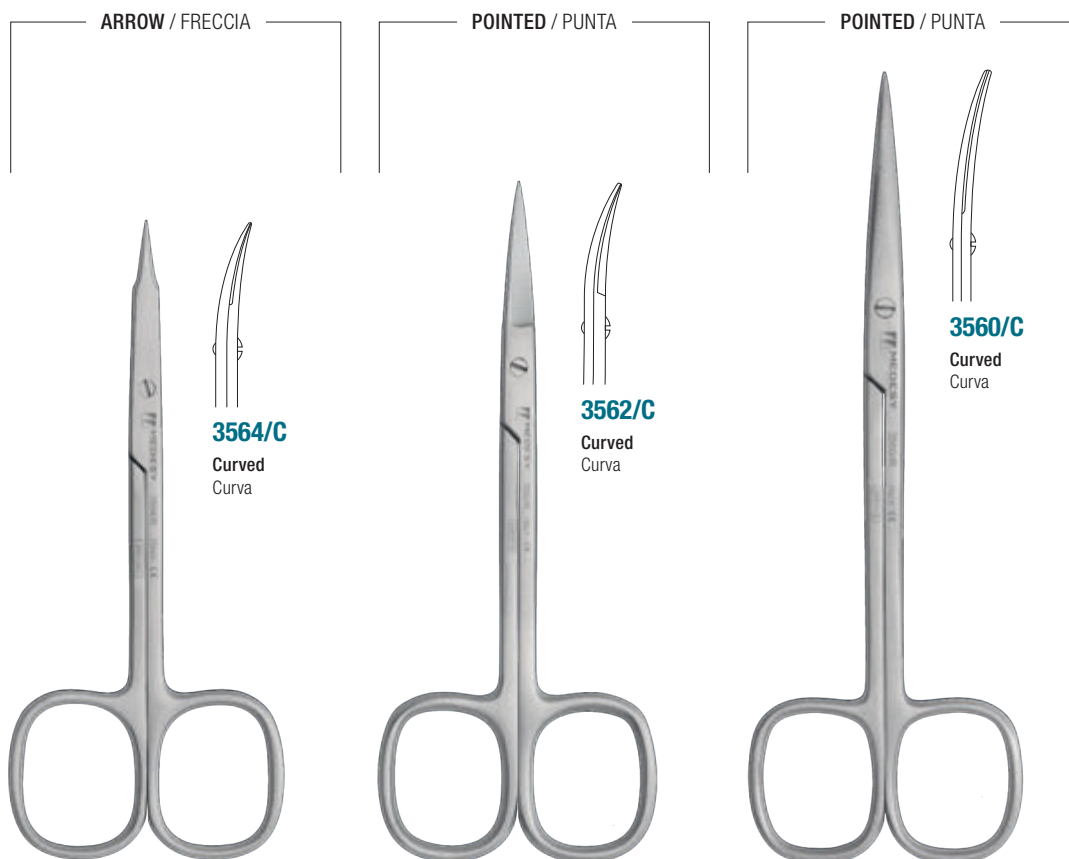

3560/C

Curved
Curva

3564/C

Curved
Curva

3562/C

Curved
Curva

3564/R (mm 115)

Straight
Retta

3562/R (mm 120)

Straight
Retta

3560/R (mm 140)

Straight
Retta

SQUARE-RING scissors, characterized by an exclusive non-standard shape ring, the line is available in three different options for the tips.

Forbici serie SQUARED, si caratterizzano proprio per la forma dell'anello non convenzionale allo standard, disponibili con 3 tipi di punte differenti.

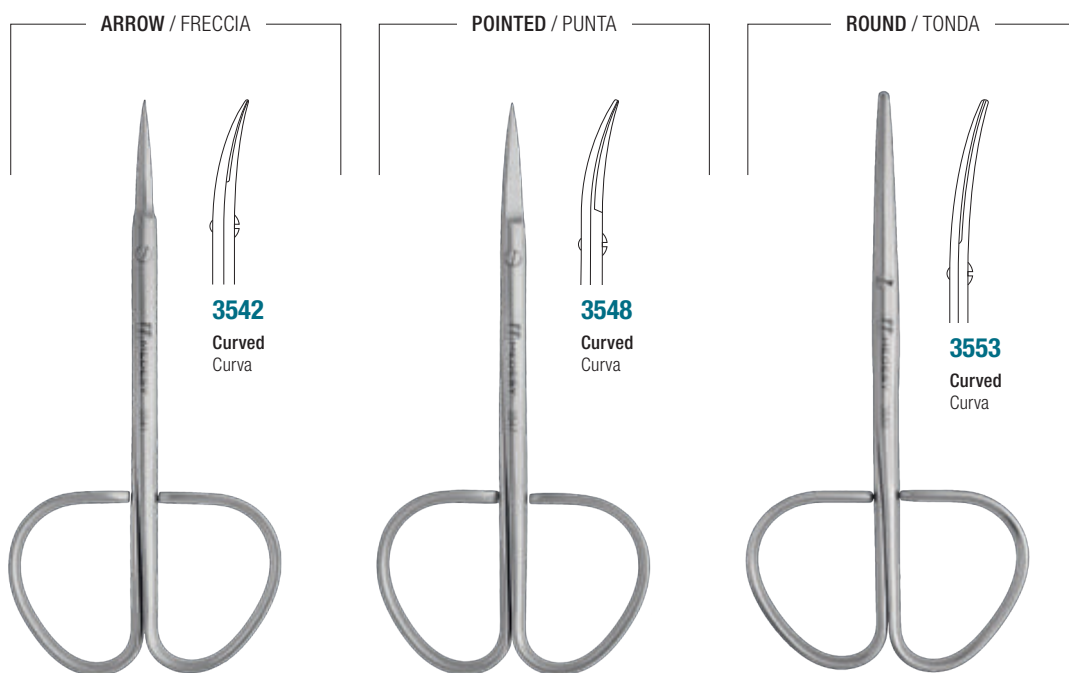

3542

Curved
Curva

3548

Curved
Curva

3553

Curved
Curva

3541 (mm 100)

Straight
Retta

3547 (mm 100)

Straight
Retta

3552 (mm 100)

Straight
Retta

MARILYN scissors, the lightest operating scissors, the extremely fine point ensures the utmost accuracy.

Forbici serie MARILYN, si caratterizzano per la loro particolare leggerezza e delicatezza in uso.

The scissors here illustrated are characterized by a fine micro serration on one of the blades, specifically applied to firmly grasp the tissue while cutting and to preclude the risk of slipping.

Le forbici qui raffigurate si caratterizzano per la micro dentatura presente su una lama, specifica per trattenere il tessuto durante il taglio ed evitandone lo scivolamento dello stesso.

SAW EDGE
DENTATA

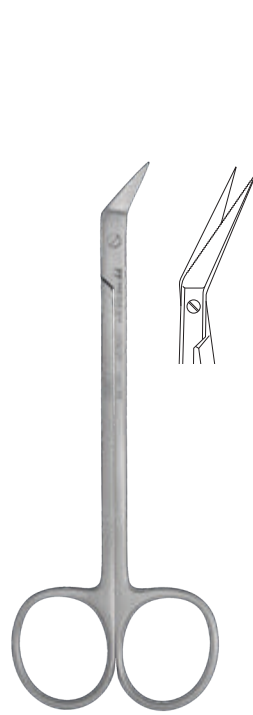

3506/120 (mm 120)

Locklin fina

Saw edge, angular
Dentata, angolare



3506 (mm 160)

Locklin

Saw edge, angular
Dentata, angolare



3503 (mm 160)

Locklin

Saw edge, angular
Dentata, angolare



3508 (mm 170)

Dean

Saw edge, angular
Dentata, angolare



3518 (mm 130)

Goldman – Fox

Saw edge, straight
Dentata, retta



3519 (mm 130)

Goldman – Fox

Saw edge, curved
Dentata, curva



3557 (mm 130)

Goldman – Fox

Saw edge, double curved
Dentata, doppia curva

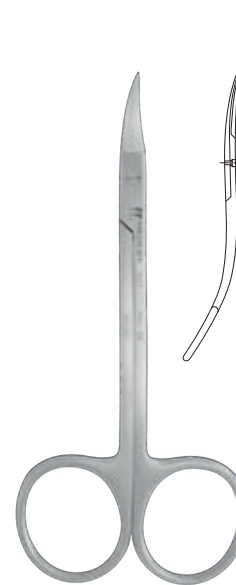

3525 (mm 115)

La Grange

Saw edge, double curved
Dentata, doppia curva



3514 (mm 120)

Neumann

Saw edge, double curved
Dentata, doppia curva



3501 (mm 120)

Kilner (Ragnell)

Straight
Retta

3502 (mm 120)

Kilner (Ragnell)

Curved
Curva



3504/1 (mm 145)

Joseph

Straight
Retta

3504/2 (mm 145)

Joseph

Curved
Curva



3509 (mm 160)

Kelly

Straight
Retta

3510 (mm 160)

Kelly

Curved
Curva



The process of "blades adjustment", for reaching a perfect alignment, carried out by expert hands.
Il processo di "regolazione" del taglio delle forbici eseguito abilmente da mani esperte.



“ MEDESY IN SPOT ”



3523
Round
Tonde



3567
Pointed
Punta



3565
Pointed-Fina
Punta-Fina



3523 (mm 145)
3526 (mm 180)
Metzenbaum
Straight
Retta



3524 (mm 145)
3527 (mm 180)
Metzenbaum
Curved
Curva



3567 (mm 145)
Metzenbaum
Straight
Retta



3568 (mm 145)
Metzenbaum
Curved
Curva



3565 (mm 145)
Metzenbaum fina
Straight
Retta



3566 (mm 145)
Metzenbaum fina
Curved
Curva



3571 (mm 160)
3572 (mm 180)
 Standard
Straight
 Retta



3573 (mm 130)
3574 (mm 160)
3575 (mm 180)
 Standard
Curved
 Curva



3517 (mm 130)
 Standard
Straight
 Retta



3515 (mm 140)
3535 (mm 200)
 Mayo
Straight
 Retta



3516 (mm 140)
3536 (mm 200)
 Mayo
Curved
 Curva



3584 (mm 120)
 Medesy
Straight
 Retta



3580 (mm 115)
 Medesy N. 1
Straight
 Retta



3581 (mm 115)
 Medesy N. 1
Curved
 Curva



3576 (mm 140)
 Standard
Straight
 Retta



3577 (mm 140)
 Standard
Curved
 Curva



3544/AN (mm 115)

Iris

Straight
Retta

3543/AN (mm 115)

Iris

Curved
Curva

3549/AN (mm 115)

La Grange

Double curved
Doppia curva

MEDESY SUPERIOR CUT SCISSORS

Uniquely sharp scissors with superior cutting capacity: razor-shape blade on one side and fine serration on the other one. The ideal combination for a firm hold and neat cut of the tissue. For easy identification these scissors have one gold ring. Medesy has recently developed a SUPERIOR CUT line variant featuring open rings handles: the best synthesis between practicability and cutting efficiency.

MEDESY SUPERIOR CUT FORBICI

Forbici uniche per le caratteristiche di affilatura: una lama estremamente affilata (effetto rasoio) e l'altra lama microdentata. Combinazione ideale per garantire la presa dei tessuti e tagli perfetti. Per l'immediata identificazione, un solo anello è dorato. Medesy ha recentemente sviluppato le forbici SUPERIOR CUT con anelli aperti: la miglior combinazione tra maneggevolezza e qualità di taglio.

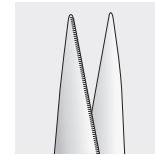

SAW EDGE
DENTATA



3545/AN (mm 130)

Goldman-Fox

Straight
Retta

3546/AN (mm 130)

Goldman-Fox

Curved
Curva

3510/AN (mm 160)

Kelly

Curved
Curva



SUPERIOR CUT WITH OPEN RINGS
SUPERIOR CUT CON ANELLI APERTI



3544/OR (mm 115)

Iris
Straight
 Retta

3543/OR (mm 115)

Iris
Curved
 Curva

3545/OR (mm 130)

Goldman-Fox
Straight
 Retta

3546/OR (mm 130)

Goldman-Fox
Curved
 Curva

ZED LINE WITH OPEN RINGS
LINEA ZED CON ANELLI APERTI

SAW EDGE
DENTATA

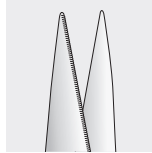

3558 (mm 110)

Zed
Saw edge
 Dentata

3559 (mm 135)

Zed
Saw edge
 Dentata

3558/TC (mm 110)

Zed
Saw edge
 Dentata

3559/TC (mm 135)

Zed
Saw edge
 Dentata





TC

3511/TC (mm 115)

Iris

Straight
Retta



TC

3512/TC (mm 115)

Iris

Curved
Curva

MEDESYS TUNGSTEN CARBIDE INSERTS
Tungsten carbide inserts bonded to upper and lower blades to ensure longer duration and higher cutting efficiency, featured by gold ring handles as internationally in use.

MEDESYS INSERTI IN CARBURO DI TUNGSTENO

Inserti al Carburo di Tungsteno TC sulle lame per assicurare maggiore capacità e durata di taglio. I 2 anelli dorati sono il tipico segno distintivo nonché un codice di riconoscimento internazionale per le forbici in TC.

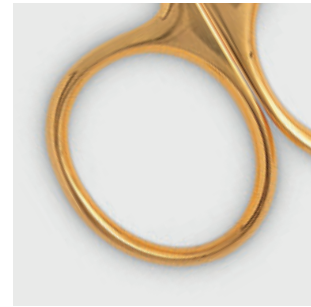

TC

3525/TC (mm 115)

La Grange

Saw edge, double curved
Dentata, doppia curva



TC

3518/TC (mm 130)

Goldman-Fox

Saw edge, straight
Microdentata, retta



TC

3519/TC (mm 130)

Goldman-Fox

Saw edge, curved
Microdentata, curva



TC

3509/TC (mm 160)

Kelly

Straight
Retta



TC

3510/TC (mm 160)

Kelly

Curved
Curva



3523/TC (mm 145)
3526/TC (mm 180)
3528/TC (mm 200)

Metzenbaum
Straight
 Retta

3524/TC (mm 145)
3527/TC (mm 180)
3529/TC (mm 200)

Metzenbaum
Curved
 Curva

3515/TC (mm 140)
3537/TC (mm 170)
3538/TC (mm 230)

Mayo
Straight
 Retta

3516/TC (mm 140)
3539/TC (mm 170)
3540/TC (mm 230)

Mayo
Curved
 Curva

“ MEDESY IN SPOT

Did you know that a pair of scissors need about 90 working steps to be completely finished?

Lo sapevi che una forbice necessita di 90 passaggi produttivi, prima di ottenere il prodotto finito? ”

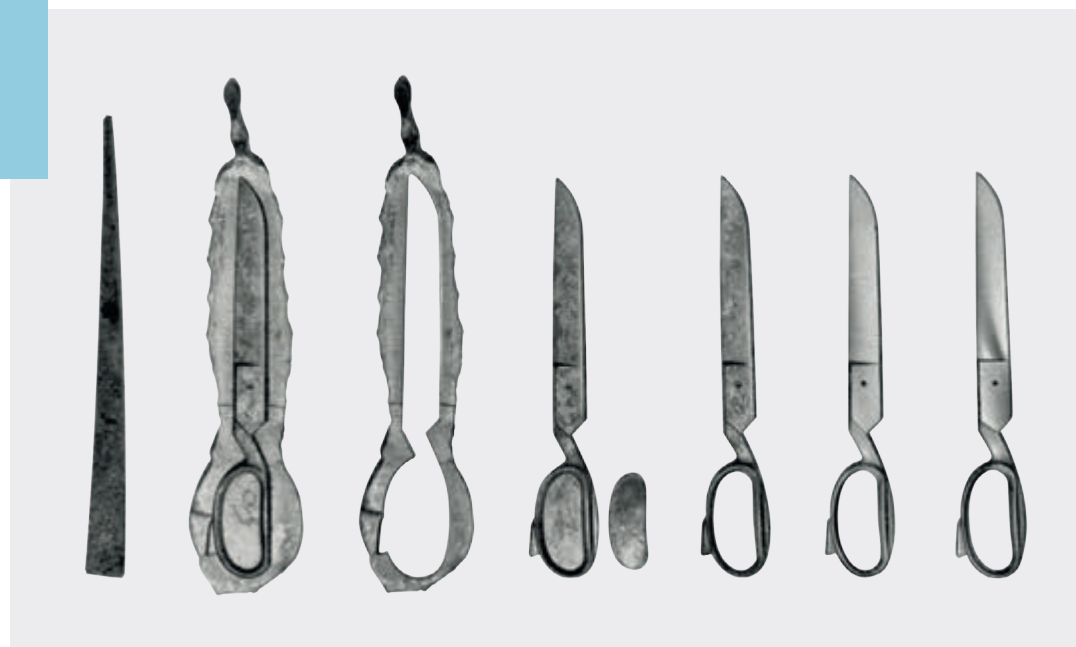

Operation cycle of a forged piece.
 Ciclo di lavorazione di un particolare forgiato.

Standard scissors are not suitable for left handers. Because of their overlapping blades they are not symmetric and therefore best suited for use with the right hand. For right-handed scissors held in the right hand, the thumb blade is closer to the user's body, so that the natural tendency of the right hand is to force the cutting blades together. Conversely, if right-handed scissors are held in the left hand, the natural tendency of the left hand would be to force the cutting blades laterally apart. Besides that, with right-handed scissors held by the right hand, the shearing edge is visible, but when used with the left hand, the cutting edge of the scissors is behind the top blade, and one cannot see what is being cut. This is why LEFT HANDERS specific scissors with reversed blades are produced.

Per le persone mancine l'uso delle normali forbici costituisce un problema perché lo strumento è asimmetrico. Se anche l'impugnatura fosse giusta, rimarrebbe il problema delle lame perché rovesciando lo strumento la lama superiore coprirebbe la linea di taglio. Usate normalmente le lame taglierebbero all'esterno delle forbici ed il punto di forza delle dita durante il taglio tenderebbe ad allontanare le 2 lame anziché stringerle, vanificando la capacità di taglio. Per questi motivi, vengono prodotte le forbici PER MANCINI.

(1:1 scale / scala 1:1)



3512/LH (mm 115)

Iris
Curved
Curva

3519/LH (mm 130)

Goldman – Fox
Saw edge, curved
Dentata, curva

3504/LH (mm 145)

Joseph
Straight
Retta

SURGICAL SCISSORS, RING LOCK

FORBICI CHIRURGICHE, RING LOCK



3590 (mm 95) (1:1 scale / scala 1:1)

Ring lock

Curved

Curva



The Ring Lock System® consists in 2 bearings (one in stainless steel and one in aluminum) and a Teflon ring; all 3 parts are assembled together under pressure.

The Ring Lock System® ensures that the blades stay aligned for a longer time and preserve a high cutting precision in the time. The blades rotate on a circumference that is 60% larger if compared to traditional scissors. This is the key for a smoother and more precise cut, allowing a longer duration of the cutting edge. The internal Teflon ring is auto lubricant and a not deformable material (used in the autoclave).

Il Sistema Ring Lock® consiste in 2 bussole sovrapposte (una in acciaio ed una in alluminio) unite da un anello in Teflon il tutto chiuso a pressione. Grazie a questo innovativo sistema, le lame ottengono una capacità di apertura maggiore del 60% circa rispetto ad una forbice tradizionale. Tale vantaggio permette di ottenere forbici più fluide con un taglio sempre preciso e lame affilate. L'anello interno in Teflon è auto lubrificante e non deformabile (uso in autoclave).

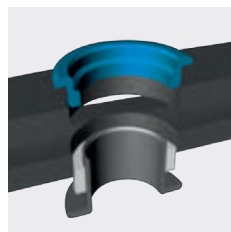

PATENT PENDING
SISTEMA BREVETTATO



3594 (mm 95) (1:1 scale / scala 1:1)

Ring lock

Curved

Curva



3596 (mm 110) (1:1 scale / scala 1:1)

Ring lock

Straight

Retta



SPECIALTY SCISSORS
FORBICI PER SPECIALITÀ

SUTURE SCISSORS
FORBICI PER SUTURE

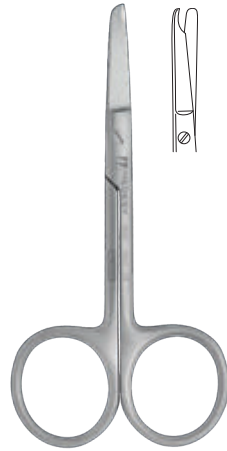

3520 (mm 90)
Spencer



3521 (mm 130)
Spencer



3521/160 (mm 160)
Spencer



3528 (mm 115)
Spencer
Angled
Angolare

BANDAGE SCISSORS
FORBICI PER GARZE



3530 (mm 90)
3531 (mm 110)
3532 (mm 140)
3533 (mm 180)
3534 (mm 240)
Lister
Bandage scissors
Forbici per garze

TISSUE NIPPER
TRONCHESE



3538 (mm 120)
Tissue nipper – For soft tissue surgery
Tronchese per lembi – Per chirurgia dei tessuti



TC

3550/TC (mm 110)
Beebee
Saw edge, straight
Dentata, retta



TC

3551/TC (mm 110)
Beebee
Saw edge, curved
Dentata, curva



3550 (mm 110)
Beebee
Saw edge, straight
Dentata, retta



3551 (mm 110)
Beebee
Saw edge, curved
Dentata, curva



3570/11 (mm 110)
High performance
Elevato rendimento



3570/9 (mm 90)
High performance
Elevato rendimento



3522 (mm 125)
Universal, saw edge
Universale, dentata

WIRE CUTTING SCISSORS

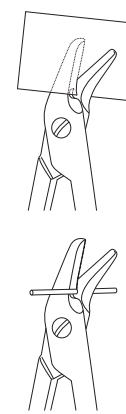

TC

3522/TC (mm 125)
Universal
Universale



(1:1 scale / scala 1:1)



3621 (mm 115)

Noyes

Straight
Retta

3624 (mm 115)

Noyes

Curved
Curva

3626 (mm 110)

Noyes

Angular 45°
Angolare 45°

3627 (mm 150)

Castroviejo

Straight
Retta

3628 (mm 150)

Castroviejo

Curved
Curva



1959 (mm 145)

Straight
Retta



1960 (mm 145)

Curved
Curva



1961 (mm 140)

Angled 45°
Angolare 45°



1957 (mm 155)

Jacobson
Straight
Retta



1958 (mm 155)

Jacobson
Curved
Curva

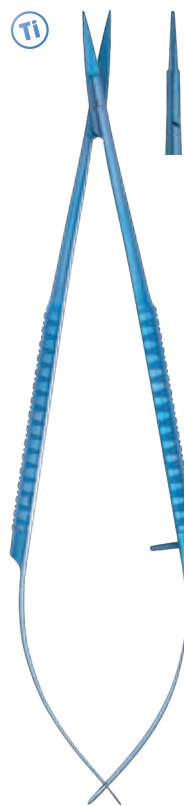

1970 (mm 180)

Straight
Retta



1971 (mm 180)

Curved
Curva



Tungsten Carbide inserts for a safe and secure hold of the needle. Fine serration 0,4 mm for thin needles. Inserti al Carburo di Tungsteno per una sicura presa dell'ago. Zigrinatura di 0,4 mm per aghi sottili.

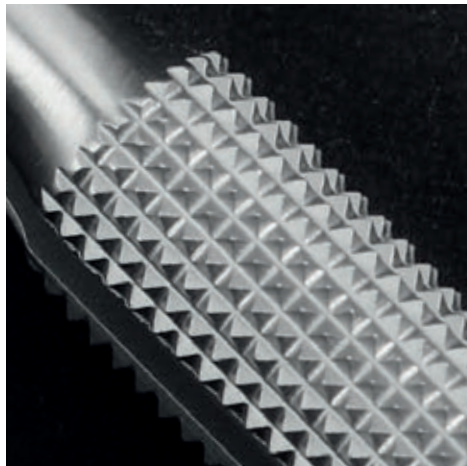

Pyramidal serration which offers a comfortable and secure hold on all moist superficies. Zigrinatura piramidale offre una presa confortevole e sicura anche su superfici umide.



MED-LOCK locking system: original for its simplicity as well as delicate in its functionality. Sistema di chiusura MED-LOCK: innovativa per semplicità e delicata nel funzionamento.

SPECIFICATIONS ON THE CODES SPECIFICHE SUI CODICI

Code
Codice
Type
Modello
Shape
Forma
Recommended suture sizes
Misura delle suture raccomandate

1910/TC (mm 160)

Barraquer

Straight / Retta

☺ 4-0, 5-0, 6-0



1:1 scale
Scala 1:1



Yellow color for TC instruments
Colore giallo per strumenti in TC

Grey color for standard instruments
Colore grigio per strumenti tradizionali

NEEDLE HOLDERS

PORTA AGHI



SURGICAL / CHIRURGIA

1910/TC
(1:1 scale / scala 1:1)

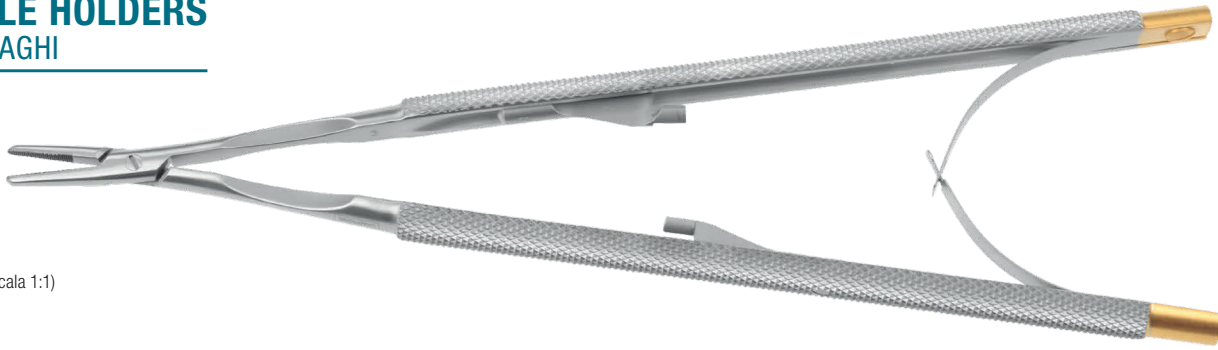

1910/TC (mm 160)
Barraquer
Straight / Retta
☪ 4-0, 5-0, 6-0

1910 (mm 160)
Barraquer
Straight / Retta
☪ 4-0, 5-0, 6-0

1911/TC (mm 160)
Barraquer
Curved / Curva
☪ 4-0, 5-0, 6-0

1911 (mm 160)
Barraquer
Curved / Curva
☪ 4-0, 5-0, 6-0



Barraquer needle holder, designed and realized with a specific finger rest pad which ensures a greater precision level by facilitating the user's control during operation.

Porta aghi Barraquer, progettato con uno specifico poggia dito il quale agevola l'utilizzo ottimizzando la precisione durante l'intervento.

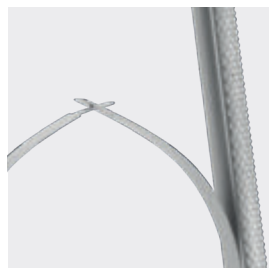
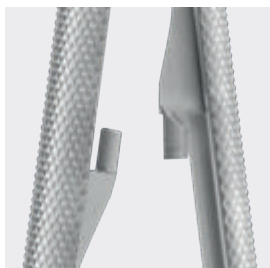

Double locking wings in tempered inox, for longer duration and perfect use.
Doppie alette di chiusura in inox temperate, per un lungo e perfetto utilizzo.

Internal spring facilitates the use of the needle holder.
La molla interna facilita l'utilizzo del porta aghi.

1922/A-TC
(1:1 scale / scala 1:1)

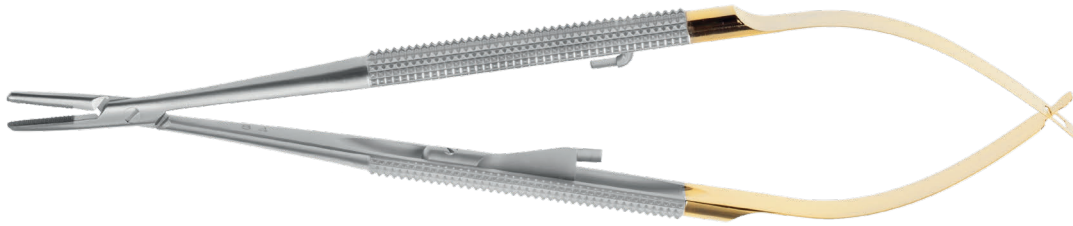

1922 series with TC extra-fine inserts of 0,3 mm

Serie 1922 con inserti TC extra fini 0,3 mm



1922/A-TC (mm 140)
Castroviejo
Straight / Retta
☞ 4-0, 5-0, 6-0

1922/A (mm 140)
Castroviejo
Straight / Retta
☞ 4-0, 5-0, 6-0

1922/B-TC (mm 140)
Castroviejo
Curved / Curva
☞ 4-0, 5-0, 6-0

1922/B (mm 140)
Castroviejo
Curved / Curva
☞ 4-0, 5-0, 6-0

1922/C
(1:1 scale / scala 1:1)

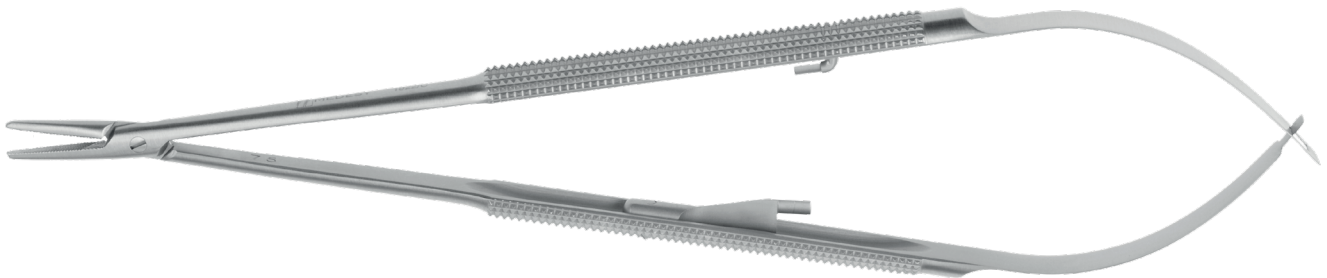

1922/C-TC (mm 180)
Castroviejo
Straight / Retta
☞ 4-0, 5-0, 6-0

1922/C (mm 180)
Castroviejo
Straight / Retta
☞ 4-0, 5-0, 6-0

1922/D-TC (mm 180)
Castroviejo
Curved / Curva
☞ 4-0, 5-0, 6-0

1922/D (mm 180)
Castroviejo
Curved / Curva
☞ 4-0, 5-0, 6-0

2000/A
(1:1 scale / scala 1:1)

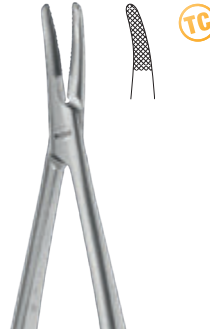

2000/A-TC (mm 140)
Castroviejo
Straight / Retta
☞ 4-0, 5-0, 6-0

2000/A (mm 140)
Castroviejo
Straight / Retta
☞ 4-0, 5-0, 6-0

2000/B-TC (mm 140)
Castroviejo
Curved / Curva
☞ 4-0, 5-0, 6-0

2000/B (mm 140)
Castroviejo
Curved / Curva
☞ 4-0, 5-0, 6-0

2000/C-TC
(1:1 scale / scala 1:1)

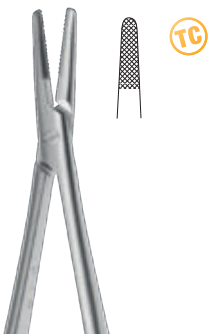
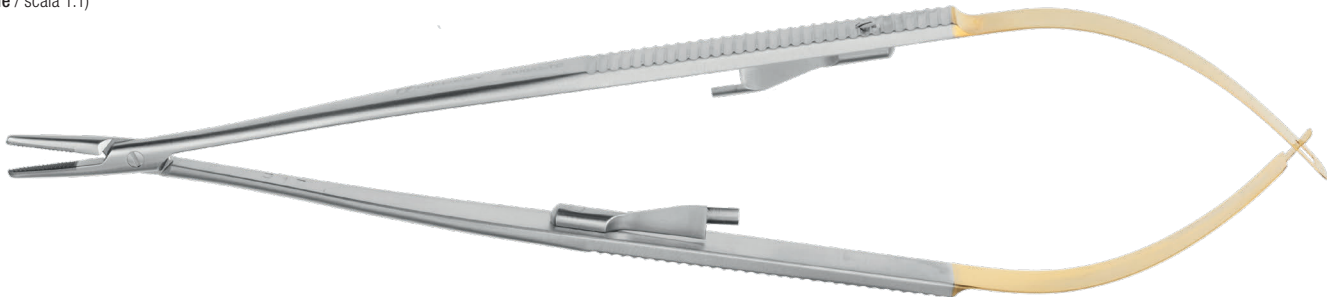

2000/C-TC (mm 180)
Castroviejo
Straight / Retta
☞ 4-0, 5-0, 6-0

2000/C (mm 180)
Castroviejo
Straight / Retta
☞ 4-0, 5-0, 6-0

2000/D-TC (mm 180)
Castroviejo
Curved / Curva
☞ 4-0, 5-0, 6-0

2000/D (mm 180)
Castroviejo
Curved / Curva
☞ 4-0, 5-0, 6-0



1855/TC

(1:1 scale / scala 1:1)

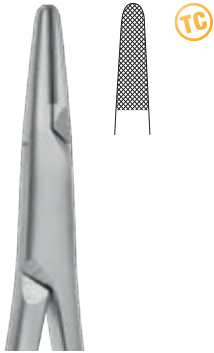

1855/TC (mm 140)
Mathieu

☞ 2-0, 3-0, 4-0



1855 (mm 140)
Mathieu

☞ 2-0, 3-0, 4-0



1856/TC (mm 170)
Mathieu

☞ 2-0, 3-0, 4-0



1856 (mm 170)
Mathieu

☞ 2-0, 3-0, 4-0

2004/TC

(1:1 scale / scala 1:1)

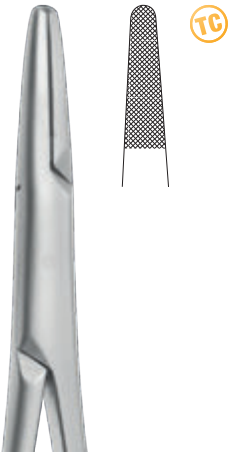

1857/TC (mm 200)
Mathieu

☞ 2-0, 3-0, 4-0



1857 (mm 200)
Mathieu

☞ 2-0, 3-0, 4-0



2004/TC (mm 120)
Boynton

☞ 4-0, 5-0, 6-0



2004 (mm 120)
Boynton

☞ 4-0, 5-0, 6-0

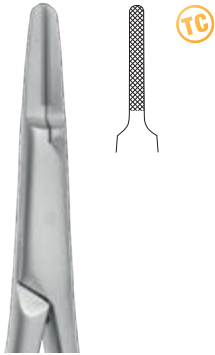

1853/TC (mm 140)
Mathieu

☞ 2-0, 3-0, 4-0



1853 (mm 140)
Mathieu

☞ 2-0, 3-0, 4-0

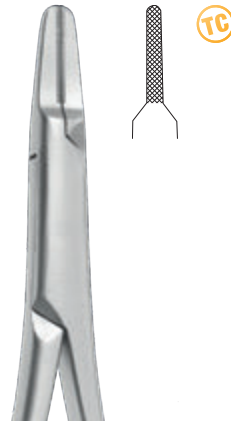

1854/TC (mm 170)
Mathieu

☞ 2-0, 3-0, 4-0



1854 (mm 170)
Mathieu

☞ 2-0, 3-0, 4-0

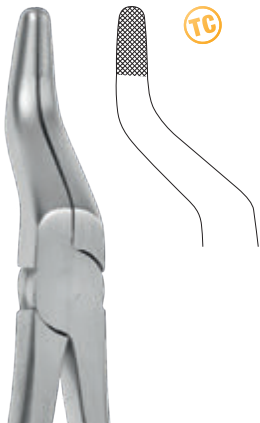

1858/MV-TC (mm 190)
Eiselsberg-Mathieu

☞ 2-0, 3-0, 4-0

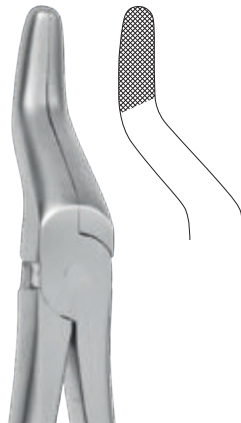

1858/MV (mm 190)
Eiselsberg-Mathieu

☞ 2-0, 3-0, 4-0

“ MEDESY IN SPOT

The internal locking hook prevents the needle holder from catching and possibly breaking the glove.

La chiusura interna alta per evitare di pizzicare e rompere i guanti in lattice. ”



1925/A
(1:1 scale / scala 1:1)

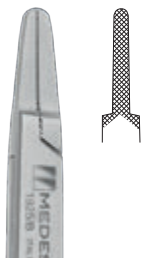

1925/A (mm 130)
Crile-Ryder

☞ 3-0, 4-0, 5-0, 6-0

1925/B (mm 150)
Crile-Ryder

☞ 3-0, 4-0, 5-0, 6-0

1925/C (mm 180)
Crile-Ryder

☞ 3-0, 4-0, 5-0, 6-0

1925/A-TC (mm 130)
Crile-Ryder

☞ 3-0, 4-0, 5-0, 6-0

1925/B-TC (mm 150)
Crile-Ryder

☞ 3-0, 4-0, 5-0, 6-0

1925/C-TC (mm 180)
Crile-Ryder

☞ 3-0, 4-0, 5-0, 6-0

1748
(1:1 scale / scala 1:1)



1924/TC (mm 130)
Baumgartner

☞ 2-0, 3-0, 4-0

1924 (mm 130)
Baumgartner

☞ 2-0, 3-0, 4-0

1748/TC (mm 130)
Halsey

☞ 3-0, 4-0, 5-0, 6-0

1748 (mm 130)
Halsey

☞ 3-0, 4-0, 5-0, 6-0

1740/TC
(1:1 scale / scala 1:1)

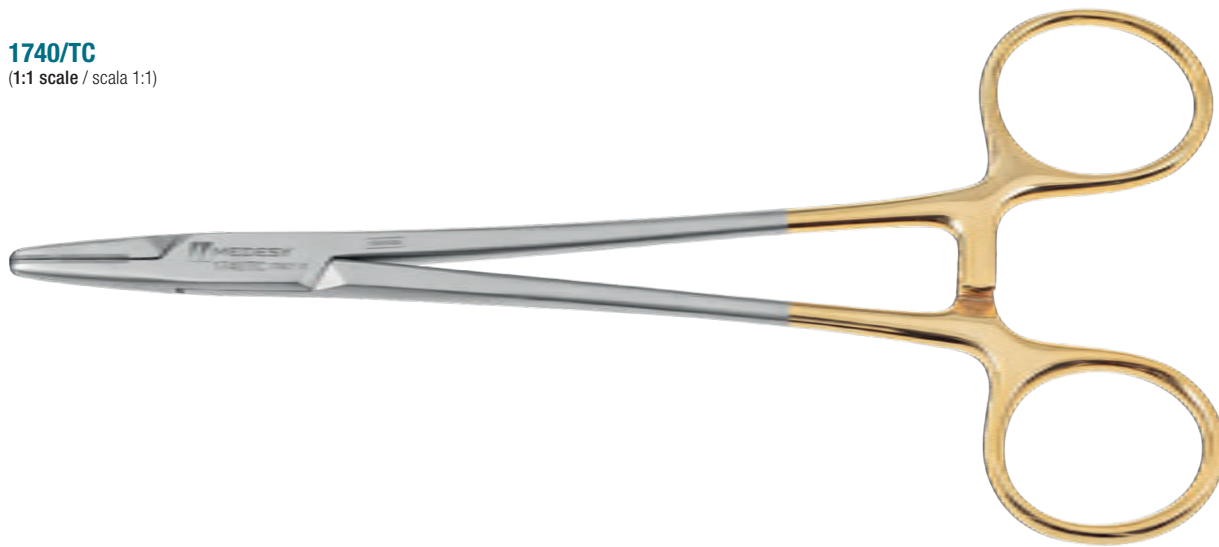

1739/TC (mm 130)
Mayo-Hegar

☞ 2-0, 3-0, 4-0



1739 (mm 130)
Mayo-Hegar

☞ 2-0, 3-0, 4-0



1740/TC (mm 160)
Mayo-Hegar

☞ 2-0, 3-0, 4-0



1740 (mm 160)
Mayo-Hegar

☞ 2-0, 3-0, 4-0

1741/TC
(1:1 scale / scala 1:1)

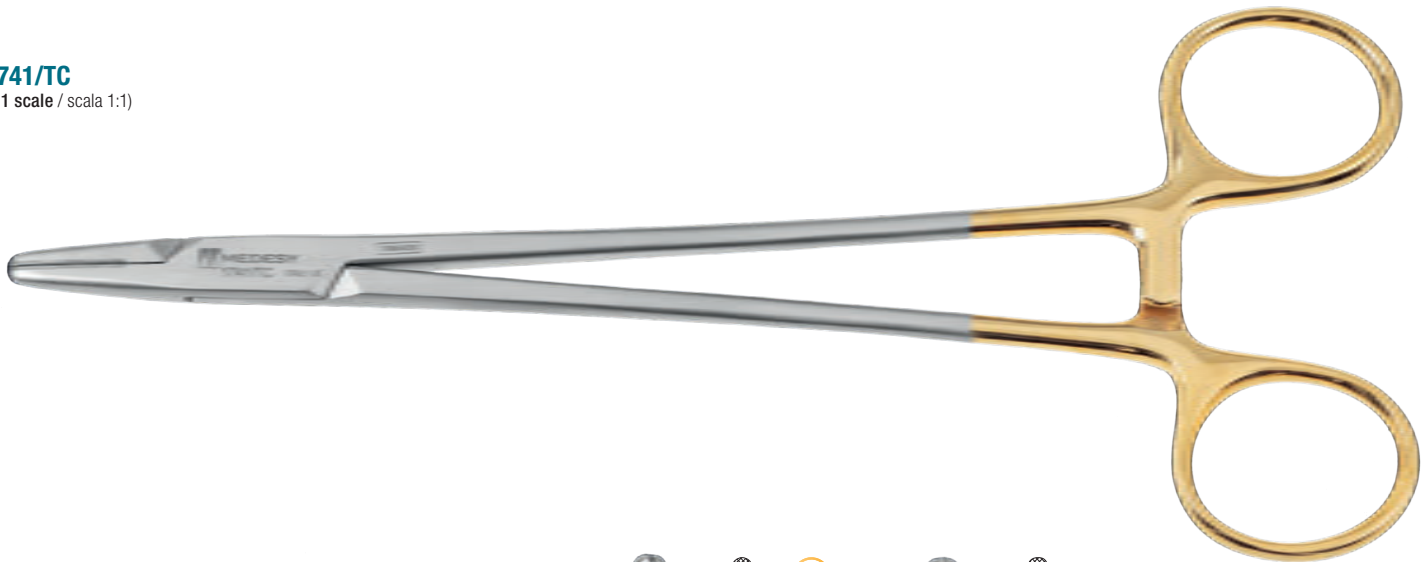

1741/TC (mm 180)
Mayo-Hegar

☞ 2-0, 3-0, 4-0



1741 (mm 180)
Mayo-Hegar

☞ 2-0, 3-0, 4-0



1742/TC (mm 200)
Mayo-Hegar

☞ 2-0, 3-0, 4-0

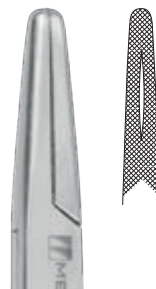

1742 (mm 200)
Mayo-Hegar

☞ 2-0, 3-0, 4-0



1735 (mm 170)
Adson

☞ 1-0, 2-0, 3-0, 4-0



1743

(1:1 scale / scala 1:1)

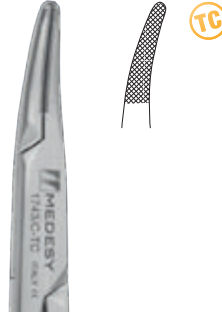
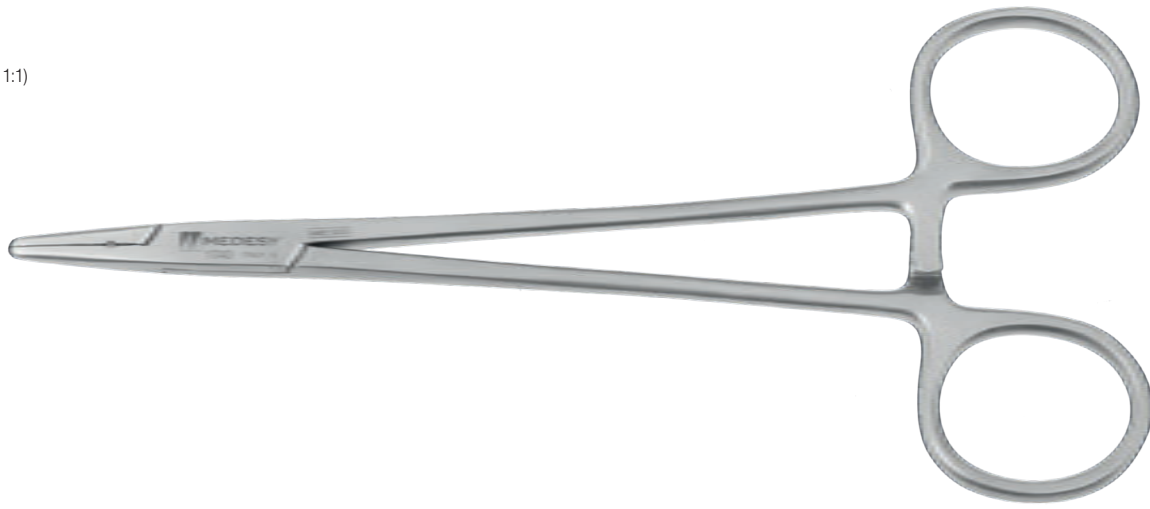

1743 (mm 150)
Crile-Wood

☞ 3-0, 4-0, 5-0, 6-0

1743/TC (mm 150)
Crile-Wood

☞ 3-0, 4-0, 5-0, 6-0

1743/C-TC (mm 150)
Crile-Wood

Curved / Curva
☞ 3-0, 4-0, 5-0, 6-0

1923

(1:1 scale / scala 1:1)

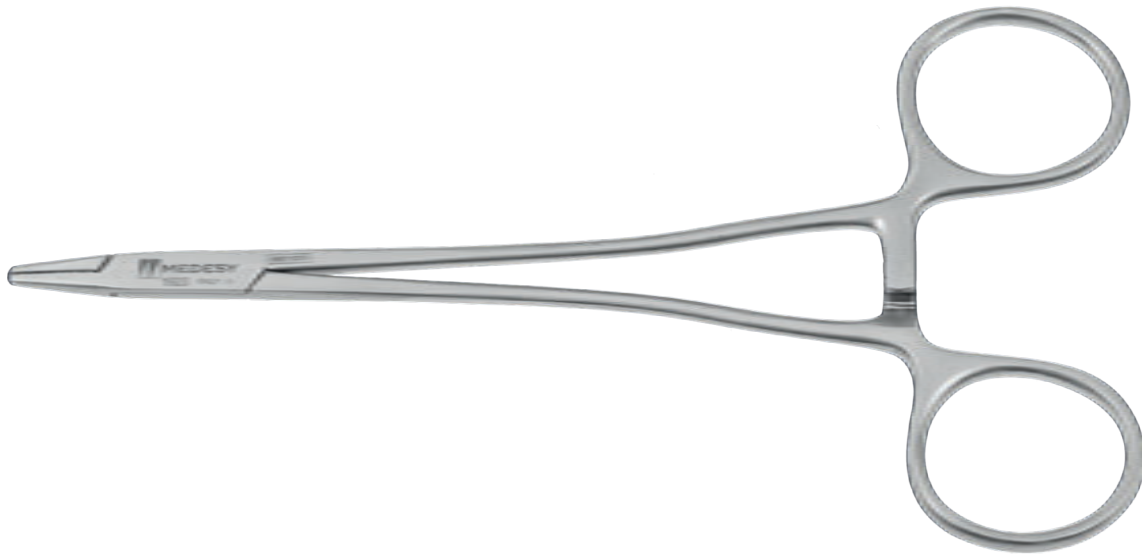

1736 (mm 120)
Derf

☞ 3-0, 4-0, 5-0

1736/TC (mm 120)
Derf

☞ 3-0, 4-0, 5-0

1923 (mm 150)
Fine Swedish

☞ 5-0, 6-0, 7-0, 8-0

1923/TC (mm 150)
Fine Swedish

☞ 5-0, 6-0, 7-0, 8-0

1862/TC
(1:1 scale / scala 1:1)



1862/TC (mm 170)
Mathieu-Olsen

☞ 2-0, 3-0, 4-0, 5-0



1862 (mm 170)
Mathieu-Olsen

☞ 2-0, 3-0, 4-0, 5-0

Needle holder with scissors
Porta aghi con forbice



1750/TC
(1:1 scale / scala 1:1)

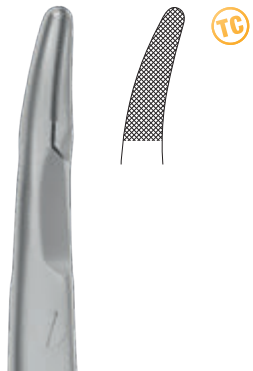

1750/TC (mm 160)
Gillies

☞ 2-0, 3-0, 4-0, 5-0



1750 (mm 160)
Gillies

☞ 2-0, 3-0, 4-0, 5-0



SURGICAL / CHIRURGIA



1744 (mm 120)
1749 (mm 140)
 Olsen-Hegar
 3-0, 4-0, 5-0

1744/TC (mm 120)
1749/TC (mm 140)
 Olsen-Hegar
 3-0, 4-0, 5-0



Needle holder with scissors
 Porta aghi con forbice

2010

(1:1 scale / scala 1:1)



Smooth
 Liscio



Smooth
 Liscio



2010 (mm 180)
 Micro needle holder Titanium
 Micro porta aghi Titanio
 Straight / Retta

2012 (mm 180)
 Micro needle holder Titanium
 Micro porta aghi Titanio
 Curved / Curva

“ MEDESYS IN SPOT

The needle-holders in pure titanium are characterized by a special lightness and high endurance degree. Manufactured with smooth tips for very thin needles (8-0, 9-0, 10-0) and a safety double-wing locking system. Blue anodized.

I porta aghi in Titanio si contraddistinguono per la loro leggerezza e resistenza in genere. Presentano punte lisce per aghi molto sottili (8-0, 9-0, 10-0) ed un sistema di chiusura a doppia aletta. Anodizzati blu.

”

SUTURE SCISSORS
FORBICI PER PUNTI SUTURE

SUTURE TWEEZERS
PINZETTE PER SUTURE



3520 (mm 90)
Spencer

3521 (mm 130)
Spencer

3528 (mm 115)
Spencer

1032 (mm 155)

1033 (mm 155)

1033/T (mm 155)

Squared tip
Punta quadra

Round tip
Punta tonda

1672/1

Suture removal kit
Kit rimozione suture

Contains / Contiene:

- | | |
|----------|------------------------|
| 1022/130 | Tweezer Perry |
| 1024 | Tweezer Meriam |
| 3520 | Scissor Spencer |
| 3521 | Scissor Spencer |
| 3528 | Scissor Spencer |
| 4905/8 | Mirror N.5 with handle |
| 560/2 | Explorer double |
| 980/10 | Gammatrix tray Tre |



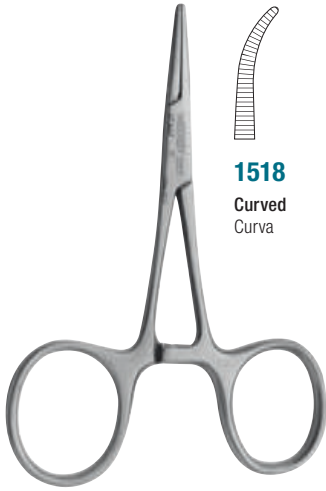

1518
Curved
Curva



1520
Curved
Curva

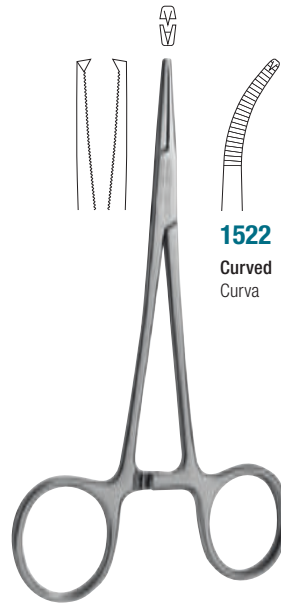

1522
Curved
Curva



1524
Curved
Curva

1517 (mm 90)
Hartmann (Baby Mosquito)
Straight
Retta

1519 (mm 125)
Halstead Mosquito
Straight
Retta

1521 (mm 125)
Halstead Mosquito 1x2
Straight
Retta

1523 (mm 140)
Kelly
Straight
Retta

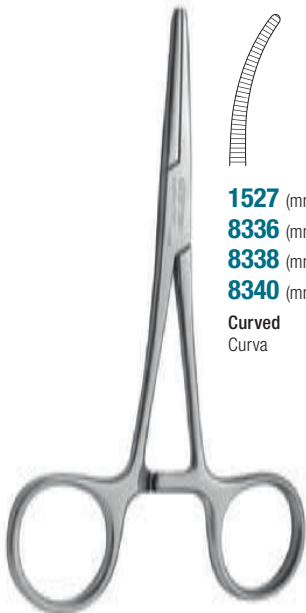

1527 (mm 140)
8336 (mm 160)
8338 (mm 180)
8340 (mm 200)
Curved
Curva

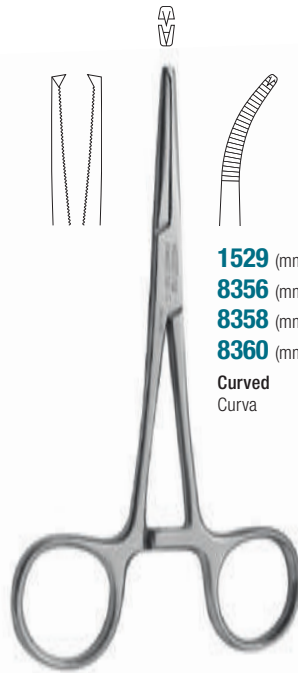

1529 (mm 140)
8356 (mm 160)
8358 (mm 180)
8360 (mm 200)
Curved
Curva



1534
Curved
Curva



8535 (mm 200)
Heiss
Curved
Curva

1526 (mm 140)
8330 (mm 160)
8332 (mm 180)
8334 (mm 200)
Rochester-Péan
Straight
Retta

1528 (mm 140)
8350 (mm 160)
8352 (mm 180)
8354 (mm 200)
Rochester-Kocher 1x2
Straight
Retta

1533 (mm 160)
Kelly-Rankin
Straight
Retta



1531 (mm 100)
1532 (mm 130)
Lorna

1530/1 (mm 150)
Allis-Baby 3:4

1530/2 (mm 200)
Allis 4:5

1530/3 (mm 200)
Allis 6:7

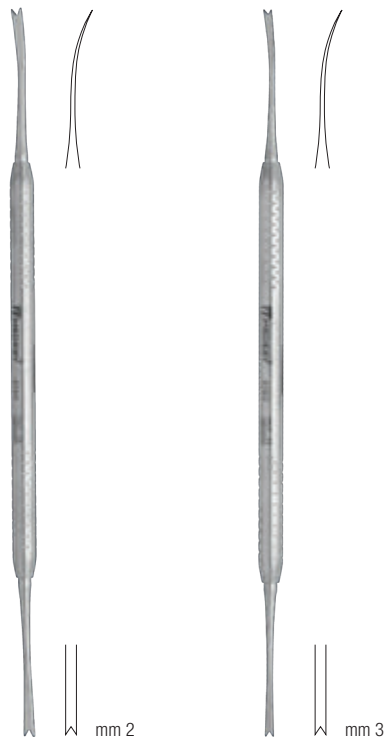

619/1
Luniatscheck
Tonsil gauze packers
Tamponatore tonsillare

619/2
Luniatscheck
Tonsil gauze packers
Tamponatore tonsillare

SUCTION TUBES / CANNULE PER ASPIRAZIONE



With round corners
and depressive hole.
Con bordi arrotondati
e foro di pressione.

910/1 (ø 1,5 mm)
910/3 (ø 3 mm)
910/4 (ø 4 mm)
910/5 (ø 5 mm)
mm 175

912/1 (ø 2,5 mm)
912/2 (ø 3 mm)
912/3 (ø 4 mm)
mm 165

911/2 (ø 2 mm)
911/3 (ø 3 mm)
911/4 (ø 4 mm)
911/5 (ø 5 mm)
Frazier
mm 190

TOWEL & DRESSING FORCEPS, TONGUE FORCEPS

PINZE PER TELI, TAMPONI, E TIRALINGUA

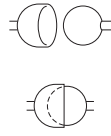

1635 (mm 140)

Backhaus

Not-perforating and not-damaging
Non perforante



1633 (mm 130)

Backhaus

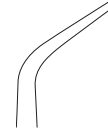

1634 (mm 90)

Backhaus



1629 (mm 90)

Jones



1513

Curved
Curva



8537 (mm 250)

8538 (mm 200)

Foerster

Dressing forceps
Pinze portatamponi



8540 (mm 180)

Collins

Tongue forceps
Pinze tiralingua



1510/1

Spare part
Ricambio

1510 (mm 170)

Young

Tongue forceps
Pinze tiralingua

MOUTH GAGS APRIBOCCA

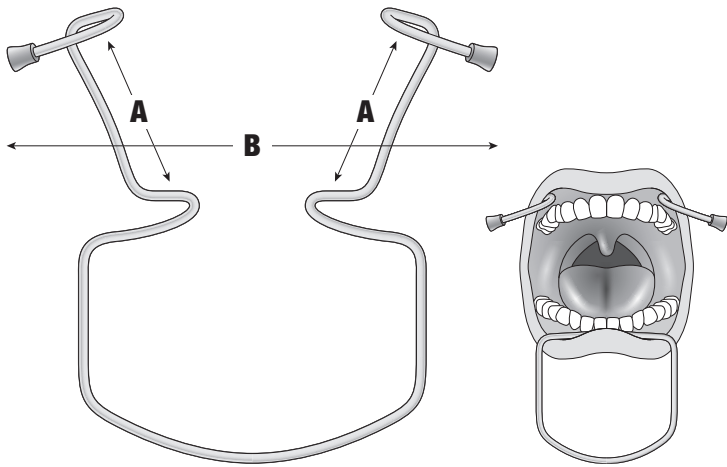

Silicon mouth props autoclavable, with security hole.
Sostegno apribocca in silicone autoclavabile, con foro di sicurezza.

825/A (Orange / Arancio – Small)

825/B (Blue / Blu – Small)

825/G (Yellow / Giallo – Small)

H 24×24 mm

826/A (Orange / Arancio)

826/B (Blue / Blu)

826/G (Yellow / Giallo)

H 32×28 mm

MEDESY – ORINGER

A B

820/1 Small / Piccolo mm 40 × 105

820/2 Medium / Medio mm 50 × 110

820/3 Large / Largo mm 60 × 115



899 (mm 110)
Molt

Tube spare part **899/G**
Gommino di ricambio **899/G**



900 (mm 140)
Molt

Tube spare part **900/G**
Gommino di ricambio **900/G**



917 (mm 160)
Roser-König



RETRACTORS – CHEEK

DIVARICATORI PER GUANCE

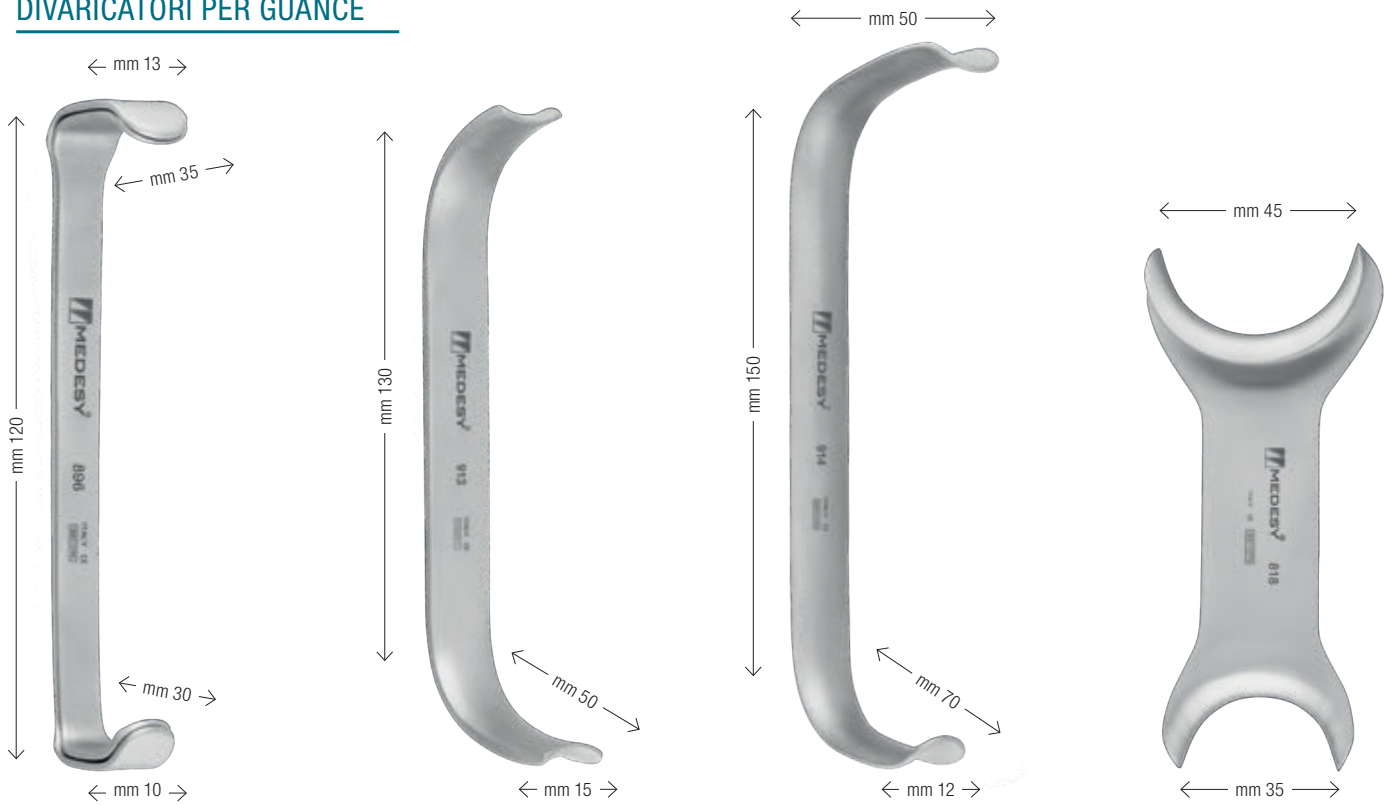

896

Farabeuf

Set of 2
Set di 2

913

Archetto

914

Archetto

818 (mm 115)

Medesy



907

Minnesota University

907/C

Cawood Minnesota

907/P

Minnesota mod. flat
Minnesota mod. piatto

907/Z

Minnesota mod. serrated
Minnesota mod. zigrinato



890 (mm 140)
891 (mm 160)
Sternberg

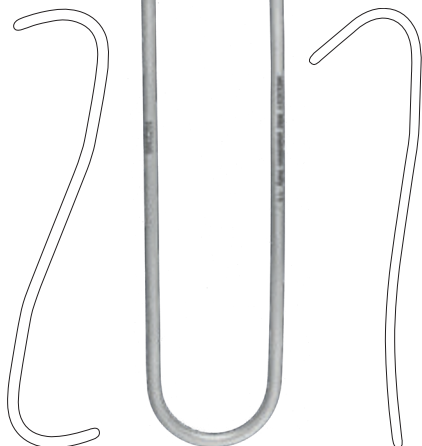

892 (mm 140)
Sternberg



901 (mm 150)
Vestibulum

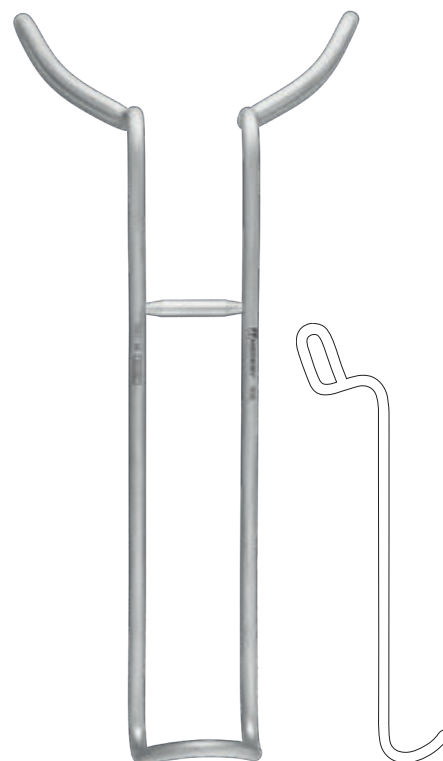

906 (mm 170)
Universal retractor
Divaricatore universale

← mm 30 →



908/1 (mm 130)

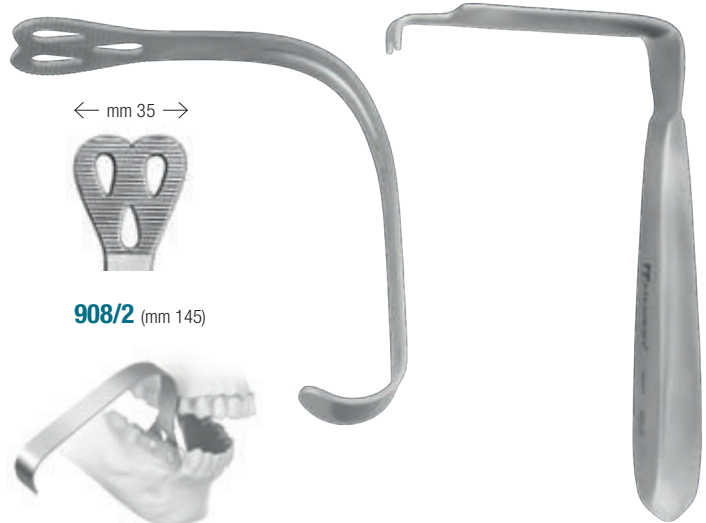

← mm 35 →



908/2 (mm 145)



908/1 (mm 110×100)
Wieder
Tongue depressor
Abbassalingua

909/1 (mm 140)
Austin
Tissue retractors
Divaricatore per tessuti

909/2 (mm 90)
Austin
Tissue retractors
Divaricatore per tessuti



893 (mm 190)
Bruenings
Tongue depressor
Abbassalingua

RETRACTORS – TISSUE

DIVARICATORI PER TESSUTI



886 (mm 155)
Senn-Miller

886/2 (mm 160)
Regnell-Davis

886/3 (mm 180)
Cope



921/1
Sharp
Appuntito

921/2
Blunt
Arrotondato

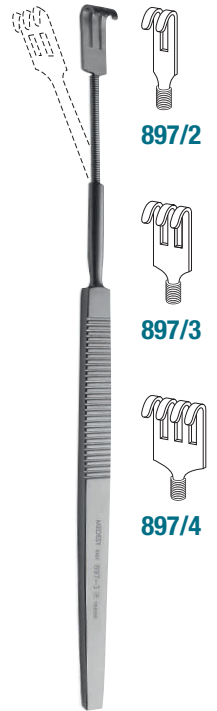

897/2

897/3

897/4

897/3 (mm 160)
Flexible, with spring
Flessibile, con molla



922/1 (mm 145)
Desmarres

922/2 (mm 145)
Desmarres

922/3 (mm 145)
Desmarres

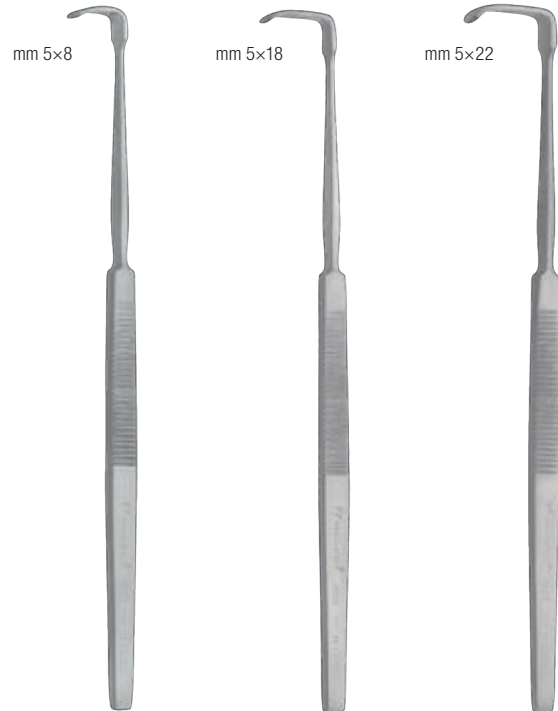

902/1 (mm 160)

902/2 (mm 160)

902/3 (mm 160)

HENAHAN & MISCH RETRACTORS

DIVARICATORI HENAHAN E MISCH



918/1

Henahan 10 mm
mm 170

918/2

Henahan 12 mm
mm 170

918/3

Henahan 16 mm
mm 170

918/4

25 mm
mm 170

919/1

Misch 1
mm 165

919/2

Misch 2
mm 165

919/3

Misch 3
mm 170

919/4

Misch 4
mm 165

MALLEABLE RETRACTORS

DIVARICATORI MALLEABILI

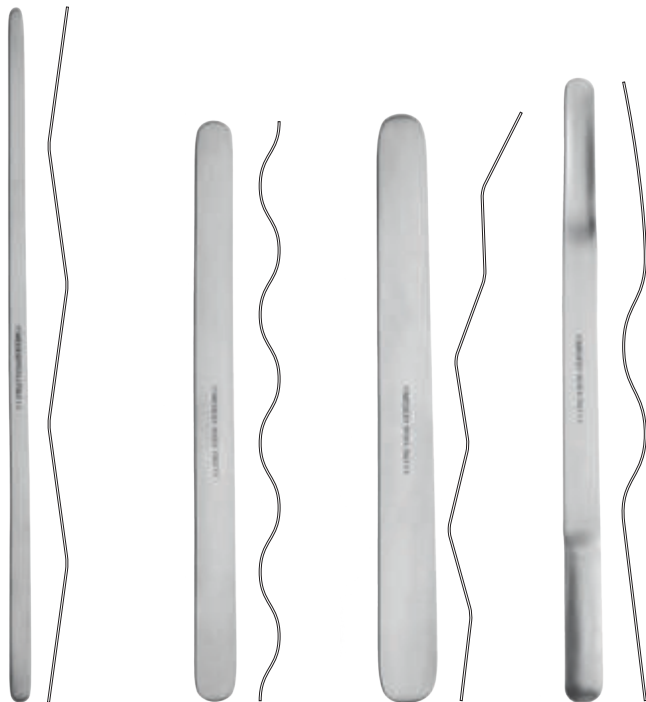

903/1

mm 240

903/2

mm 200

903/3

mm 205

903/4

Lame de Tessier
mm 215



916

Obwegeser
mm 150

Chin retractor
Divaricatore per mento



SURGICAL / CHIRURGIA

RETRACTORS – CHEEK AND TISSUE

DIVARICATORI PER GUANCE E TESSUTI



mm 40×11

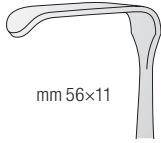

mm 56×11

889/2 (mm 215)

Kocher

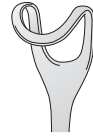

887/1 (mm 14×17)

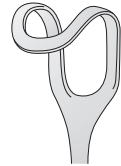

887/2 (mm 20×22)

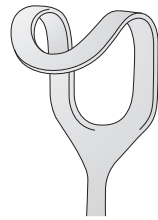

887/3 (mm 26×30)



mm 20×30



mm 35×11

889/1 (mm 215)

Kocher

887/1 (mm 190)

Middeldorpf

915 (mm 220)

Wassmund

923 (mm 215)

Obwegeser/Ramus



(mm 30×10)

888/2

(mm 40×10)



888/3

(mm 40×13)



888/4

(mm 50×10)

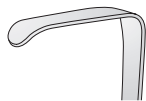

888/5

(mm 50×13)

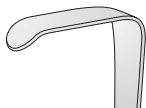

(mm 40×11)



905/2

(mm 55×11)



888/1 (mm 215)

Langenbeck

905/1 (mm 210)

Kocher

924 (mm 200)

Orientable
Orientabile

SOFT TISSUE RETRACTORS

DIVARICATORI PER TESSUTI MOLLI



The tip pointing down allows more control of the grip, meanwhile it leaves you a better view for the operation. The convex and grooved shape of the blade provides a better support on the lip and makes the grip less traumatic.

La punta rivolta verso il basso permette un maggior controllo della tenuta, e nel contempo lascia maggior visuale per l'intervento. La forma scanalata e convessa della lama, permette un migliore appoggio al labbro e rende meno traumatica la tenuta.

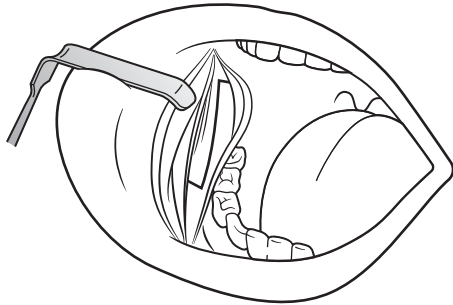

925/1 (mm 7×25)



925/4 (mm 12×55)



925/2 (mm 10×35)



925/5 (mm 14×70)



925/3 (mm 10×42)



925/6 (mm 16×80)



925/1 (mm 210)
Obwegeser internal

The tip pointing up makes the use of retractor less traumatic for soft tissue. The convex and grooved shape of the blade provides a better support on the lip and makes the grip less traumatic.

La punta rivolta verso l'alto rende l'utilizzo del divaricatore meno traumatico per i tessuti molli. La forma scanalata e convessa della lama, permette un miglior appoggio del labbro e rende meno traumatica la tenuta.

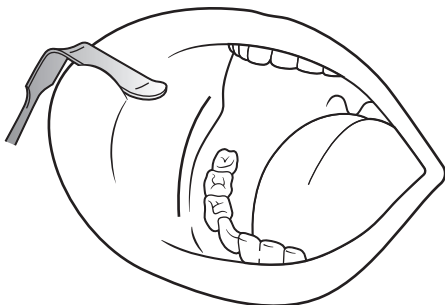

926/1 (mm 7×25)



926/4 (mm 12×55)



926/2 (mm 10×35)



926/5 (mm 14×70)



926/3 (mm 10×42)



926/6 (mm 16×80)



926/1 (mm 210)
Obwegeser external





1672/2

Content / Contenuto:

- 1007/10-TO** Tweezer De Bakey mini
- 1049/OY** Tweezer round OY
- 1050/OY** Tweezer round OY
- 1922/D-TC** Needle holder Castroviejo
- 3628** Scissors Castroviejo
- 3638** Scalpel handle micro blades
- 3638/64** Micro blade box (not shown)
- 856** Periosteal Medesy
- 871/2-4** Periosteal Molt
- 980/10** Gammafix tray Tre

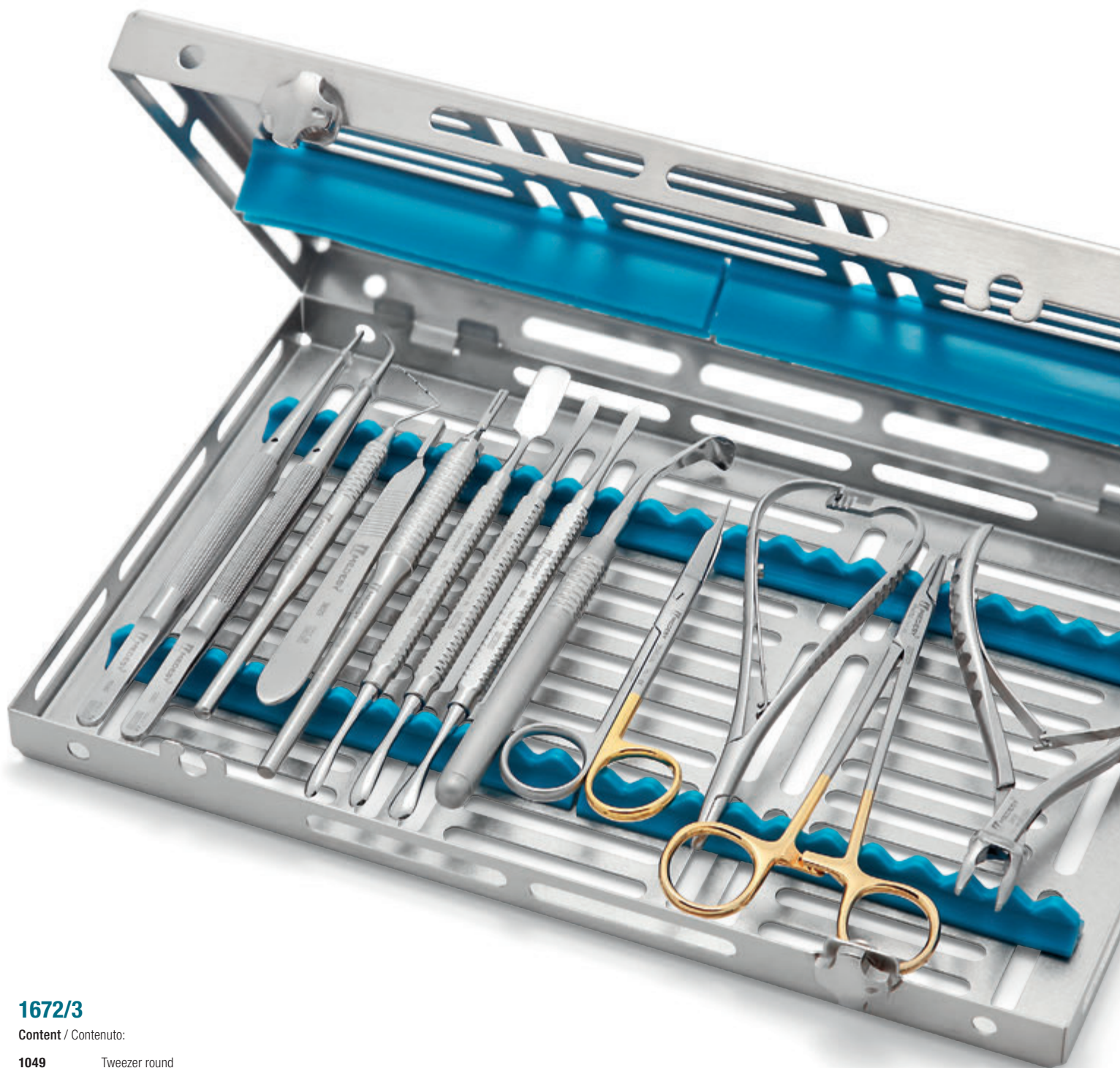

1672/3

Content / Contenuto:

1049	Tweezer round
1050	Tweezer round
1743/TC	Needle holder Crile-Wood
1855	Needle holder Mathieu
3546/AN	Scissor Goldman-Fox
3629	Scalpel handle Bad Parker
3637/16	Scalpel handle adjustable
3809	Bone rongeur Micro Friedman
548/4 PT	Probe CP15
872/P14	Periosteal Goldman-Fox
878	Periosteal Prichard
882	Periosteal Molt N. 9
919/2	Retractor Misch N. 2
981/20	Gammatrix tray Cinc



In line with our project of improving the quality, functionality and durability of the entire range of syringes we are now introducing a selection of innovative syringes made of specific stainless steels which can guarantee the below mentioned characteristics.

La ricerca finalizzata ad aumentare la qualità, funzionalità e durata delle siringhe Medesy, continua con l'introduzione di siringhe prodotte interamente con specifici acciai inossidabili, i quali garantiscono le peculiarità sotto indicate.

Interchangeable tips: for European needles (Metric) characterized by a circular thread; for American needles (Inch) with fully smooth thread.

Puntali intercambiabili: filettatura Europea (metrica) riconoscibili dal segno circolare; filettatura Americana (inch) completamente lisci.

Anchoring tip with very innovative helicoidal shape which has been specifically designed to enable a better hooking and unhooking of the carpule rubber seal, (hold by clockwise turning /release anti-clockwise turning). *Patented.*

Innovativo arpione elicoidale, ideato per agevolare l'aggancio ed il rilascio del gommino carpule: si aggancia avvitando in senso orario, mentre si rilascia avvitando in senso antiorario. *Brevettato.*

Smooth and neat lines ensure a more practical handling and an extremely easy cleaning.

Superfici lineari e levigate per maggior comfort d'uso e praticità di pulizia.

Watch the video!
Guarda il video!

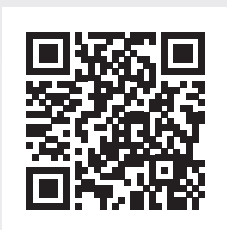



4953/1 (ml 1,8 EU)
4953/2 (ml 1,8 AM)

F

R Revolver

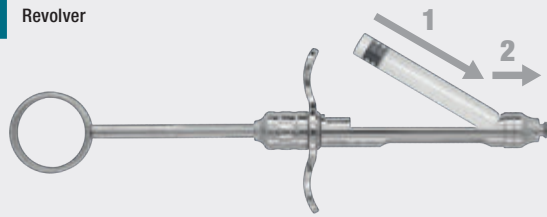

F Folding

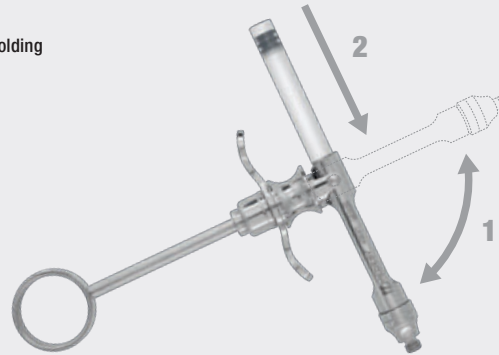

EU European – METRIC thread
Puntale europeo – METRICO



AM American – INCH thread
Puntale americano – INCH



4940/1 (ml 1,8 EU)
4940/2 (ml 1,8 AM)

R



4941/1 (ml 1,8 EU)
4941/2 (ml 1,8 AM)

R



4942/1 (ml 1,8 EU)
4942/2 (ml 1,8 AM)

R



SYRINGES TRADITIONAL

SIRINGHE TRADIZIONALI

Standard syringes,
chromed brass type.
Siringhe stile tradizionale,
prodotte in ottone cromato.



4960 (ml 1,8 EU/AM) **R**



4961 (ml 1,8 EU/AM) **R**



4956 (ml 1,8 EU/AM) **R**



4958/1 (ml 1,8 EU) **R**
4958/2 (ml 1,8 AM) **R**
Cook-Waite



4959/1 (ml 1,8 EU) **F**
4959/2 (ml 2,2 AM)



4959/1 NOA (ml 1,8 EU) **F**
4959/2 NOA (ml 2,2 AM) **F**
Not aspirating
Non aspirante



6164
Box for used needles
Box porta aghi usati

ADVANTAGES OF INTRALIGAMENTAL ANESTHESIA:

- Automatic limitation of the power pressure.
- Anesthetizing of a single tooth.
- No numbness of the tongue, lips or cheek.
- Simultaneous treatment of teeth in different quadrants.
- Supports regional block anesthesia.
- Eliminates the risk of haematoma.
- Lower emotional impact on patient.
- Less anesthetic needed.

FEATURES:

- Fully autoclavable.
- Removable headpiece with angled threaded nozzle for the injection needle.
- Viewing chamber with safety sleeve for carpule cartridge.
- Handle servo dosing lever with optimal support for index finger for a gradual advance of the dosing plunger resetting key.
- No waiting time between injections and beginning of treatment.
- Excellent depth of anesthesia combined with shorter duration.
- Much less pain than standard injections (infiltration anesthesia in hard palate, intrapulpal or intraseptal injections or for papillectomy).
- A smaller quantity of given anaesthetic.
- Needle suggested: 30G.

As opposed to a classical infiltration or block anesthesia, this method injects the local anesthesia directly into the dental ligament (periodontal ligament) and thus guarantees a rapid, profound and total anesthesia of a single tooth.

Contrariamente all'anestesia tradizionale che coinvolge un'intera zona, questo metodo inietta l'anestesia locale direttamente nel legamento del dente e ciò garantisce una rapida, profonda e totale anestesia di un solo dente.

I VANTAGGI DELL'ANESTESIA INTRALIGAMENTALE:

- Limitazione automatica della potenza di pressione.
- Effetto circoscritto al solo dente da trattare.
- Assenza d'intorpidimento dei tessuti molli.
- Trattamento simultaneo di denti localizzati in zone diverse.
- Effetto rapido e profondo.
- Elimina il rischio di ematomi.
- Minore impatto emotivo sul paziente.
- Minor anestetico utilizzato.

CARATTERISTICHE:

- Completamente sterilizzabile in autoclave.
- Parte terminale rimovibile con una punta angolata per l'inserimento dell'ago.
- Camera a vista con un astuccio di sicurezza per la cartuccia.
- Manico con leva di servo-dosaggio con un ottimo supporto del dito indice per un avanzamento graduale del pistone di dosaggio.
- Nessuna attesa tra l'iniezione e l'inizio del trattamento.
- Eccellente profondità dell'anestesia e breve durata.
- Molto meno dolore rispetto alle tradizionali iniezioni.
- Minore quantità di anestetico somministrato.
- Ago suggerito: 30G.

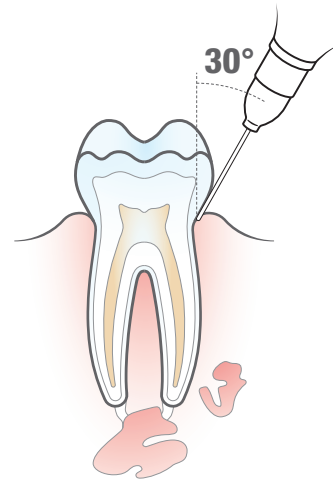

4962/1

(ml 1,8 EU)
(0,2 ml/click)

4962/2

(ml 1,8 AM)
(0,2 ml/click)



4963/1

(ml 1,8 EU)
(0,07 ml/click)

4963/2

(ml 2,2 AM)
(0,07 ml/click)



MEDESJJECT INTRALIGAMENTAL SYRINGES

SIRINGHE PER ANESTESIA INTRALIGAMENTARE MEDESJJECT



“Suitable for uppers and lowers, just turning the front barrel”

(1:1 scale / scala 1:1)



4964/EU-INOX
4964/AM-INOX

(ml 1,8)
(0,06 ml/click)



(1:1 scale / scala 1:1)



4964/EU-DA
4964/AM-DA

(ml 1,8)
(0,06 ml/click)

Aluminium – Dark
Alluminio – Nera

(1:1 scale / scala 1:1)



4964/EU-SI
4964/AM-SI

(ml 1,8)
(0,06 ml/click)

Aluminium – Silver
Alluminio – Argento

(1:1 scale / scala 1:1)



4964/EU-OR
4964/AM-OR

(ml 1,8)
(0,06 ml/click)

Aluminium – Orange
Alluminio – Arancio



TISSUE-PERIODONTAL TWEEZERS

PINZETTE PER TESSUTI



1027/90

Taylor
mm 90



1027/120

Taylor
mm 120



1027/150

Taylor
mm 150



1027/180

Taylor
mm 175



Serrated points
Punte zigrinate



1028/90-OY

Taylor
mm 90



1028/120-OY

Taylor
mm 120



1028/150-OY

Taylor
mm 150



1028/180-OY

Taylor
mm 175



1 x 2
ø mm 0,9



1x2
ø mm 0,6

1035/0,6-0Y

Semken
mm 125

Straight
Retta



1x2
ø mm 0,6

1031/0,6-0Y

Semken
mm 125

Curved
Curva



1x2
ø mm 0,9

1020/0,9-0Y

Gerald
mm 175

Straight
Retta



1x2
ø mm 0,9

1040/0,9-0Y

Gerald
mm 175

Curved
Curva



1042

Gerald
mm 175

Straight
Retta



1044

Gerald
mm 175

Curved
Curva



1049/D

mm 175

Diamond coated
Diamantata



1050/D

mm 175

Diamond coated
Diamantata



1x2
ø mm 0,9

1049/OY

Round 1x2
mm 175

Straight
Retta



1x2
ø mm 0,9

1050/OY

Round 1x2
mm 175

Curved
Curva



1049

Round
mm 175

Straight
Retta



1050

Round
mm 175

Curved
Curva



Atraumatic tissue tweezers, for gripping membrane and tissue safely. The special serration prevents the perforation of the tissue.

Pinzette per tessuti atraumatiche, per una salda e sicura presa di membrane e tessuti. La speciale zigrinatura evita la perforazione dei tessuti stessi.

(1:1 scale / scala 1:1)

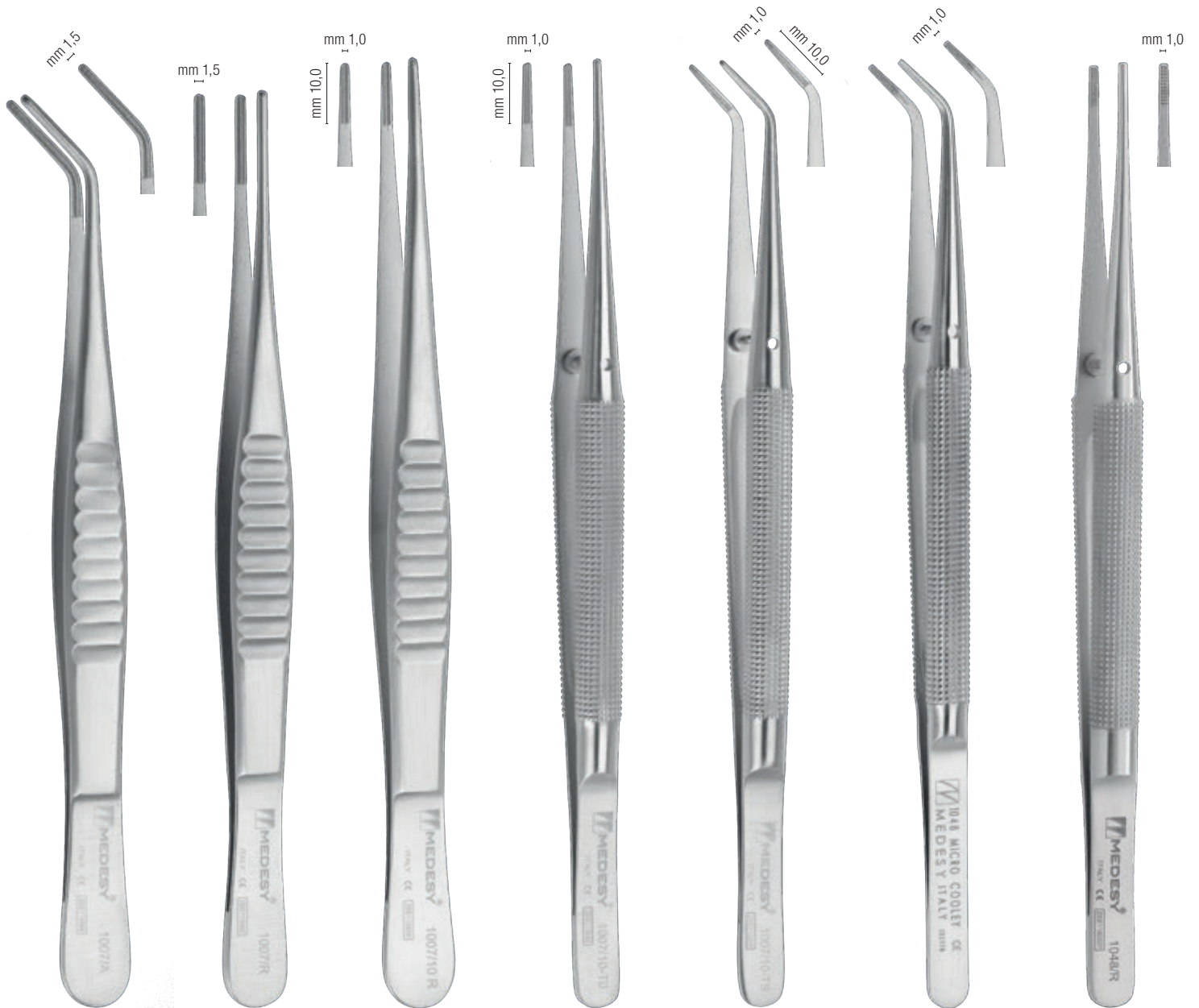

1007/A

De Bakey
mm 150

Curved
Curva

1007/R

De Bakey
mm 150

Straight
Retta

1007/10-R

De Bakey
mm 155

Straight
Retta

1007/10-T0

De Bakey
mm 155

Straight
Retta

1007/10-TS

De Bakey
mm 155

Curved
Curva

1048

Micro Cooley
mm 155

Curved
Curva

1048/R

Micro Cooley
mm 155

Straight
Retta



1045/OY
Adson 1 × 2
mm 150



1046
Adson
mm 150



1012/OY
Micro Adson 1 × 2
mm 120



1016/OY
Micro Adson 1 × 2
mm 120



1017
Micro Adson
mm 120



1052
Russian
mm 150



1013/TC
TC Adson-Brown
mm 120



1014/TC
TC Micro-Adson
mm 120



1015/TC
TC Adson
mm 120



1059/TC
TC General
mm 155



1060/TC
TC Potts Smith
mm 180

(1:1 scale / scala 1:1)



Serrated
Zigrinata



TC inserts
Inserti TC



Diamond
Diamantata



1 x 2 + Diamond
1 x 2 + Diamantata



0,7 mm hole
Foro 0,7 mm

1063
Micro
mm 180

1063/TC
Micro TC
mm 180

1064/D
Micro D
mm 180

1064/OY
Micro OY
mm 180

1064/T
Micro T
mm 180

(1:1 scale / scala 1:1)



Fine
Fina



1 x 2
Fine
Fina

Teeth below
Denti in basso



Teeth on side
Denti laterali



1 x 2

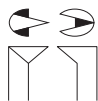

1070
Bishop-Harman
mm 90

1072
Bishop-Harman
mm 90

1074
Gill-Hess
mm 75

1078
Barraquer-Katzin (Colibri)
mm 75

1034
Jeweler
mm 130

1037
Jeweler
mm 120

1038
Jeweler
mm 120

MICROSURGICAL NEEDLE HOLDERS

PORTA AGHI MICROCHIRURGICI



Diamond points
Punte diamantate



1920/C-D (mm 180)
Castroviejo Diamond
Straight / Retta
⌣ 6-0, 7-0, 8-0

1920/D-D (mm 180)
Castroviejo Diamond
Curved / Curva
⌣ 6-0, 7-0, 8-0



KIT MICRO SOFT TISSUE

KIT MICROCHIRURGIA PER TESSUTI MOLLI



1x2
ø mm 0,9



1x2
ø mm 0,9



TC



1049/OY
mm 180
Round 1x2

1050/OY
mm 180
Round 1x2

1922/D-TC
Castroviejo
Curved
Curva

1958
mm 155
Curved
Curva

1309/9
mm 170
Sinus lift instruments
Scollatori endostali

3638
mm 135
Scalpel handle for micro blades
Manico lame per microchirurgia

3638/67
Sterile scalpel blades
Package 25 pcs
Lame per bisturi sterili
Confezione 25 pz

1954/KIT

Content / Contenuto:

- 1049/OY** Tweezer round, straight
- 1050/OY** Tweezer round, curved
- 1922/D-TC** Needle holder
- 1958** Scissor spring action (mm 155)
- 1309/9** Sinus lift (mm 170)
- 3638** Scalpel handle micro blades
- 3638/67** Micro blades N-67 (box not shown)
- 980/9** Gammafix tray Doi



KIT MICROSURGERY BASIC

KIT PER MICROCHIRURGIA BASICO

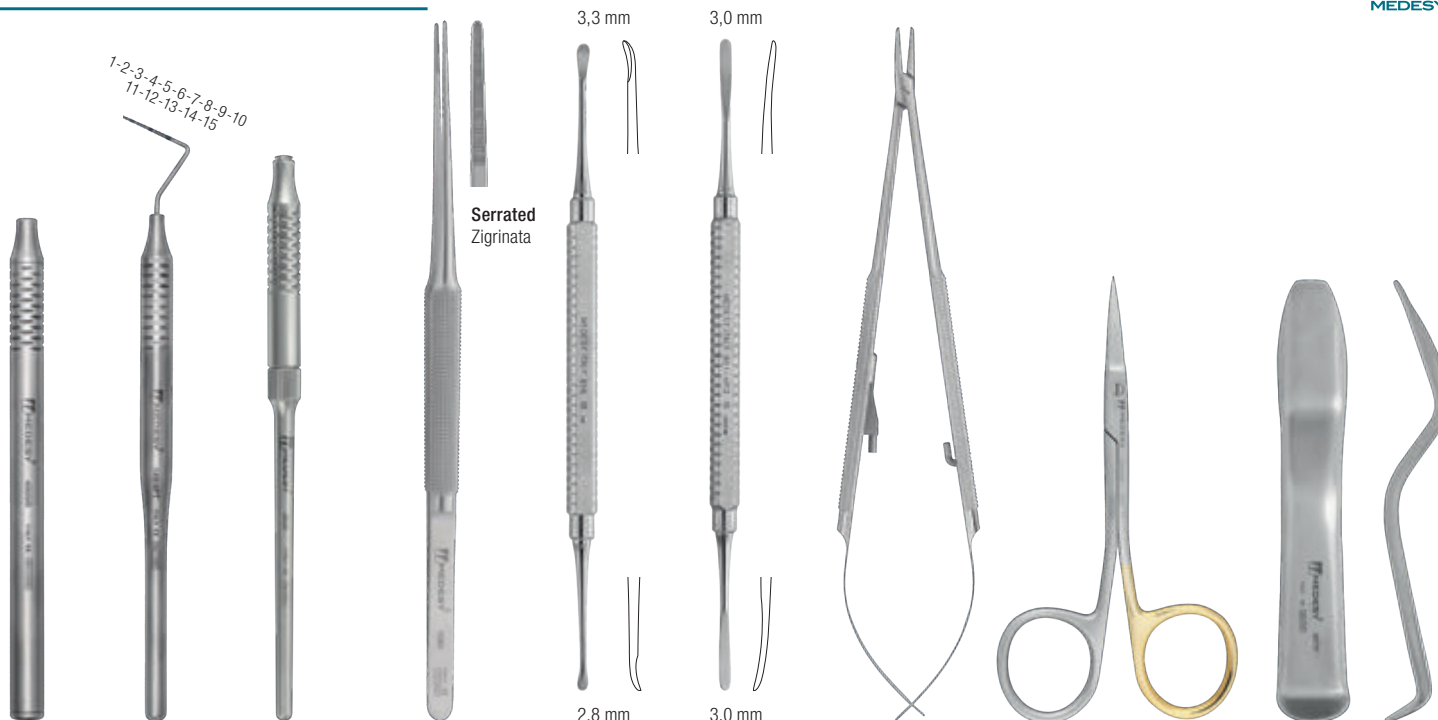

4905/8

mm 120
ø mm 8
Hollow handle
Manico vuoto

548/4 PT

CP15
University of
North Carolina

3638

mm 135
**Scalpel handle
for micro blades**
Manico lame
per microchirurgia

1063

Micro
mm 180

856

Medesy

851/HP3

3,3 mm
3,0 mm

1920/D-D

mm 180
Castroviejo Diamond
Curved
Curva
6-0, 7-0, 8-0

3544/OR

mm 115
Iris
Straight
Retta

907/P

Minnesota mod. flat
Minnesota mod. piatto

1956/KIT

Content / Contenuto:

1063	Microsurgical tweezer serrated
1920/D-D	Microsurgical needle holder diamond
3544/OR	Iris scissor Open rings AN cut
3638	Scalpel handle for micro blades
4905/8	Mirror handle with mirror #4
548/4PT	Periodontal probe CP15
851/HP3	Periosteal elevator HP3
856	Periosteal elevator MSY
907/P	Retractor Minnesota flat
981/19	Gammatrix tray Quatri



SURGICAL / CHIRURGIA

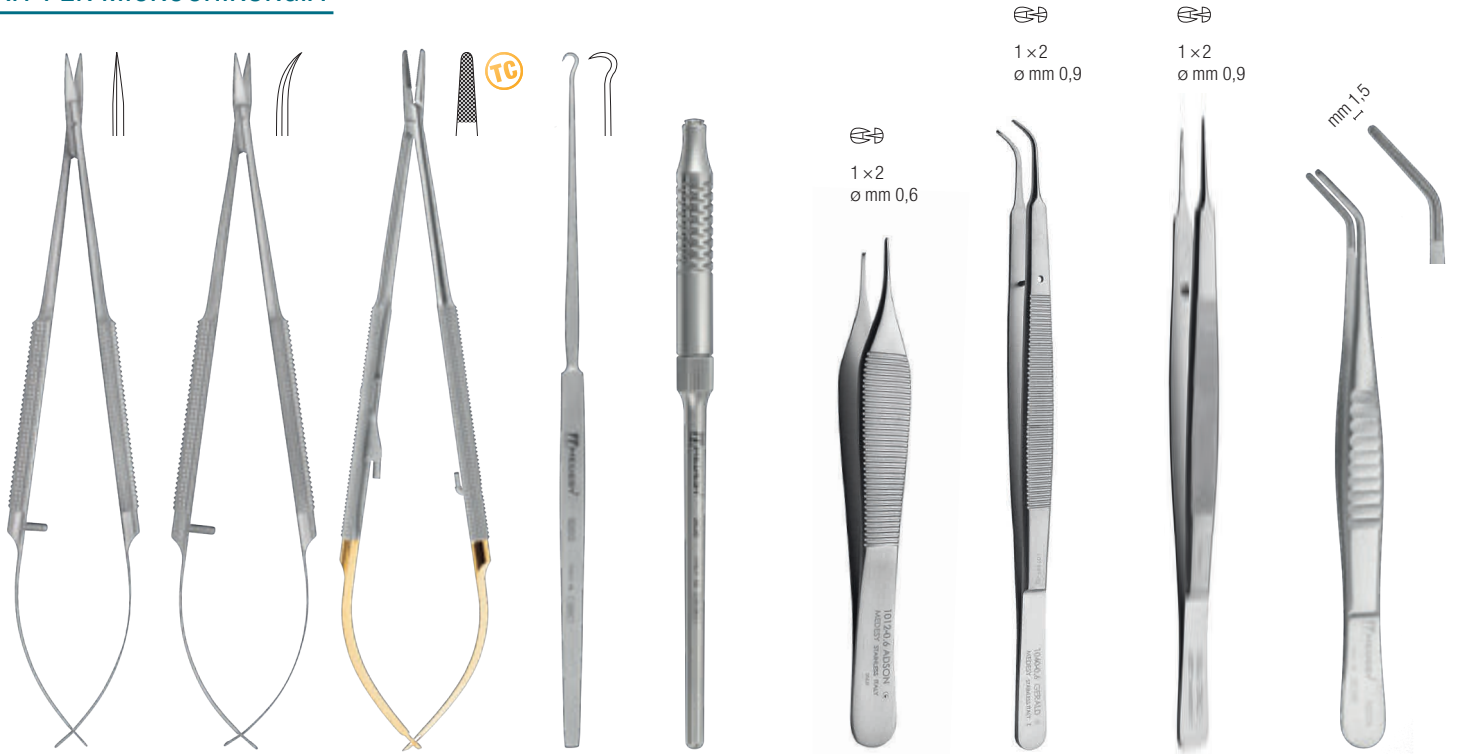

1959
mm 150

Straight
Retta

1960
mm 150

Curved
Curva

1922/C-TC
mm 180
Castroviejo

Straight
Retta

⤿ 4-0, 5-0, 6-0

920/2
mm 180
Gillies

Medium
Medio

3638
mm 135

Scalpel handle
for micro blades
Manico lame
per microchirurgia

1012/OY
mm 120
Micro Adson 1x2

1040/0,9-OY
mm 175
Gerald

1020/0,9-OY
mm 175
Gerald

1007/A
mm 150
De Bakey

Curved
Curva

1950/KIT

Content / Contenuto:

- | | |
|--------------------|---------------------------------|
| 1007/A | Tweezer De Bakey |
| 1012/OY | Tweezer micro Adson |
| 1020/0,9-OY | Tweezer Gerald |
| 1040/0,9-OY | Tweezer Gerald |
| 1922/C-TC | Needle holder Castroviejo |
| 1959 | Microsurgical scissors |
| 1960 | Microsurgical scissors |
| 3638 | Scalpel handle for micro blades |
| 920/2 | Retractor Gillies |
| 981/20 | Gammatrix tray Cinc |







DROP SHAPE MIRROR

The mirror is an indispensable tool for inspecting the oral cavity, soft tissues, anterior and posterior teeth and for all kind of conservative treatment. An improvement to these standard procedures has been achieved with the introduction of our new "drop shape" mirror which facilitates the control of the soft tissues, better protects the tongue wall and above all it offers a larger view of the superior molar portion and of the oral cavity in general. Furthermore the elongated "drop shape" guarantees a wider reflection surface and therefore a major visibility of the oral cavity. *(Protected by international patent)*

SPECCHIETTO A GOCCIA

Lo specchietto odontoiatrico rappresenta lo strumento necessario per l'ispezione del cavo orale, dei tessuti molli, denti anteriori e posteriori e come protezione nelle manovre conservative. Una miglioria per tutte queste attività è ottenuta con l'introduzione del nuovo specchietto "a goccia" il quale agevola il controllo dei tessuti molli, protegge la lingua e offre una più ampia retrospettiva del versante vestibolare. In aggiunta, il nuovo specchietto "a goccia" garantisce una maggior luce riflessa aumentando così la luminosità del cavo orale. *(Protetto da brevetto internazionale)*

4903/10RO

Rhodium
Box 6 pcs
Rodio
Scatola 6 pezzi



MOUTH MIRRORS SPECCHIETTI



**MOUTH MIRRORS
IN BOX OF 12 PCS**
SPECCHIETTI IN
CONFEZIONI DA 12 PZ

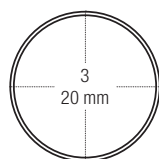

4903/3
Plane N. 3
Piano N. 3

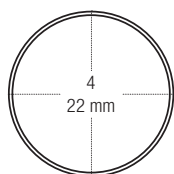

4903/4
Plane N. 4
Piano N. 4

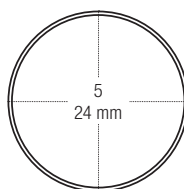

4903/5
Plane N. 5
Piano N. 5

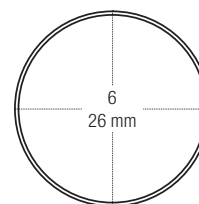

4903/6
Plane N. 6
Piano N. 6

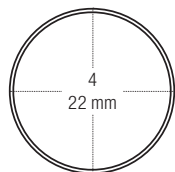

4903/4RO
Rhodium N. 4
Al Rodio N. 4

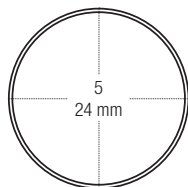

4903/5RO
Rhodium N. 5
Al Rodio N. 5

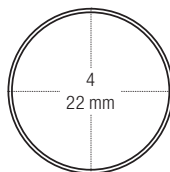

4903/4MA
Magnifying N. 4
Concavo ingrandente N. 4

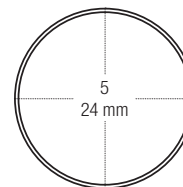

4903/5MA
Magnifying N. 5
Concavo ingrandente N. 5

**DOUBLE SIDE MIRRORS
IN BOX OF 6 PCS**
SPECCHIETTI DOPPI
IN CONFEZIONI DA 6 PZ



4910/4RO
Rhodium N. 4
Al Rodio N. 4



4910/5RO
Rhodium N. 5
Al Rodio N. 5



DIAGNOSTIC / DIAGNOSTICA

MOUTH MIRRORS HANDLES

MANICI PER SPECCHIETTI



4905/6 (mm 120)
ø mm 6



4905/8MV (mm 125)
ø mm 8
Anatomic
Anatomico



4905/8 (mm 120)
ø mm 8
Hollow handle
Manico vuoto



4905/10 (mm 120)
ø mm 10
Hollow handle
Manico vuoto



4900 (mm 120)
Octagonal handle
Manico ottagonale



4902 (mm 125)
Hollow handle
Manico vuoto



4904 (mm 130)
Hollow handle
Manico vuoto

AVAILABLE CONE-SOCKET



4906/GR (mm 120)
Aluminium green
Alluminio verde



4906/SI (mm 120)
Aluminium silver
Alluminio argento



4906/RE (mm 120)
Aluminium red
Alluminio rosso



4906/YE (mm 120)
Aluminium yellow
Alluminio giallo



4906/BL (mm 120)
Aluminium blue
Alluminio blu

“ MEDESY IN SPOT

ATTENTION: handles made in anodized aluminium: for a correct maintenance do not use products that are too alkaline or acid as they may discolor the surface. More info on www.medesy.it

ATTENZIONE: manici in alluminio anodizzati, non utilizzare prodotti troppo alcalini o acidi in quanto possono decolorare la superficie. Maggiori informazioni su www.medesy.it”

COTTON AND DRESSING TWEEZERS

PINZETTE PER MEDICAZIONI



PREVENTS SIDE-SLIPPING OF TIPS
EVITA L'ACCAVALLARSI DELLE PUNTE



1022/130 (mm 130)
1022/150 (mm 150)
Perry

1023 (mm 150)
Flagg

1024 (mm 160)
Meriam

1026 (mm 150)
College

1124/D (mm 160)
Meriam
Diamond coated
Diamantata

1049/D (mm 175)
Diamond coated
Diamantata

1050/D (mm 175)
Diamond coated
Diamantata



1122 (mm 130)
Perry

1123 (mm 150)
Flagg

1124 (mm 160)
Meriam

1126 (mm 150)
College

1126/L (mm 150)
College
Smooth
Liscia

1120 (mm 150)
College
Light pattern
Modello leggero

1118 (mm 150)
College
With lock
Con fermo



DIAGNOSTIC / DIAGNOSTICA

555/9

(1:1 scale / scala 1:1)



555/2
555/2.HL8



555/23
555/23.HL8



555/9
555/9.HL8



555/16
555/16.HL8



555/11
555/11.HL8



555/6
555/6.HL8



555/8
555/8.HL8



555/8A
555/8A.HL8



555/10
555/10.HL8



555/12
555/12.HL8



555/3
555/3.HL8



555/3A
555/3A.HL8



555/5
555/5.HL8



555/17
555/17.HL8



555/17A
555/17A.HL8

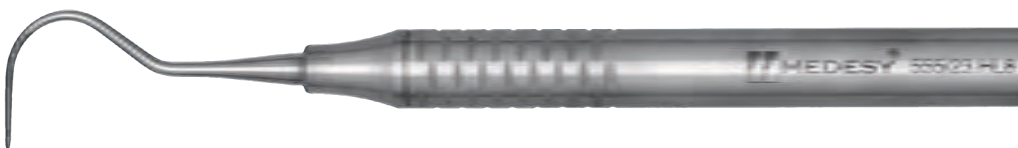

“ MEDESYS IN SPOT

*Explorers now available
also with the brand
new Dalila 8mm handle,
try and feel the best comfort
also in the diagnostic phase!*

*Specilli ora disponibili anche
nel nuovo manico Dalila 8mm,
prova un comfort maggiore
anche in fase diagnostica!*

”

EXPLORERS EXTRA THIN

SPECILLI EXTRA FINI



556/2 Extra thin Extra fino	556/23 Extra thin Extra fino	556/9 Extra thin Extra fino	556/6 Extra thin Extra fino	556/8A Extra thin Extra fino
--	---	--	--	---

Brand new micro-explorers, thinner and more flexible than standard explorers for an extremely delicate touch and precise control of the instrument.

Nuovi micro-specilli, più sottili e flessibili rispetto lo specillo tradizionale per elevare il grado di sensibilità in fase di esplorazione.

1670/1

Diagnostic kit
Kit diagnostico

Content / Contenuto:

- 1024** Tweezer Meriam
- 4905/8** Mirror handle with mirror # 5
- 548/4** Probe CP15
- 560/2** Explorer double 23/17
- 978** Gammafix tray UN

Content can be changed upon request
Su richiesta il contenuto può essere cambiato

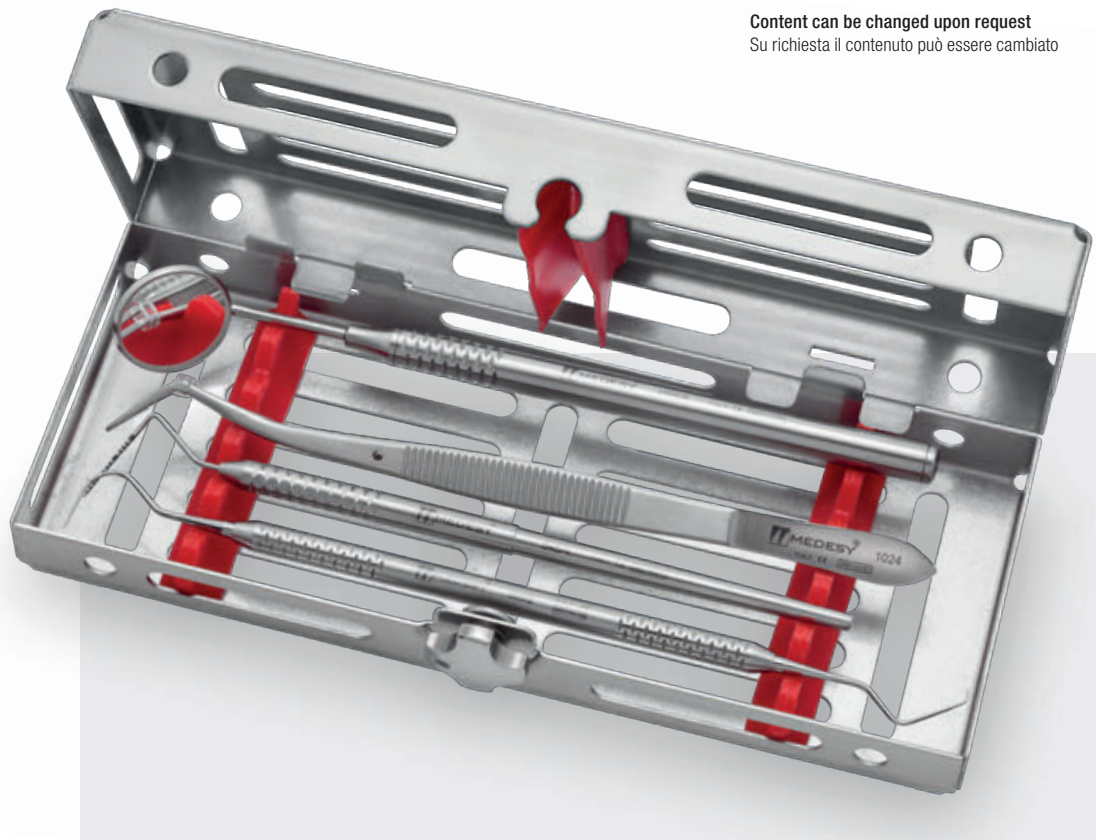

EXPLORERS DOUBLE-ENDED SPECILLI DOPPI

560/1

(1:1 scale / scala 1:1)



560/1
560/1.HL8

Explorer N. 23-17
Specillo N. 23-17

560/2
560/2.HL8

Explorer N. 23-17A
Specillo N. 23-17A

560/3
560/3.HL8

Explorer N. 23-6
Specillo N. 23-6

560/4
560/4.HL8

Explorer N. 6-3
Specillo N. 6-3

560/5-6
560/5-6.HL8

Explorer N. 5-6
Specillo N. 5-6

560/17-3A
560/17-3A.HL8

Explorer N. 17-3A
Specillo N. 17-3A



CNC Dept., for the manufacturing of Medesy's handle and tips.
Reperto torni automatici CNC, per la produzione dei manici Medesy e relative punte.



New double-ended micro-explorer angled as Gracey 11-12, ideal for periodontal assessment and detection of subgingival calculus in deep pockets.

Nuovo micro-specillo doppio con pieghe stile Gracey 11-12, ideale per diagnosi parodontale in calcoli subgingivali e tasche profonde.

556/11-12

Extra thin N. 11-12
Estra fino N. 11-12



PERIODONTAL PROBES

SONDE PARODONTALI



Blue titanium marks.
Marchiatura in titanio blu.



548/1 PT
(1:1 scale / scala 1:1)



548/1 PT
CP12S-O.M.S.



548/2 PT
CP11



548/3 PT
CP12



548/4 PT
CP15
University of North Carolina



548/5 PT
WHO



548/6 PT
CP10



Black laser marks.
Marchiatura a laser nero.



548/1
(1:1 scale / scala 1:1)



548/1
CP12S-O.M.S.



548/2
CP11



548/3
CP12



548/4
CP15
University of North Carolina



548/5
WHO



548/6
CP10



DIAGNOSTIC / DIAGNOSTICA



546/1
(1:1 scale / scala 1:1)

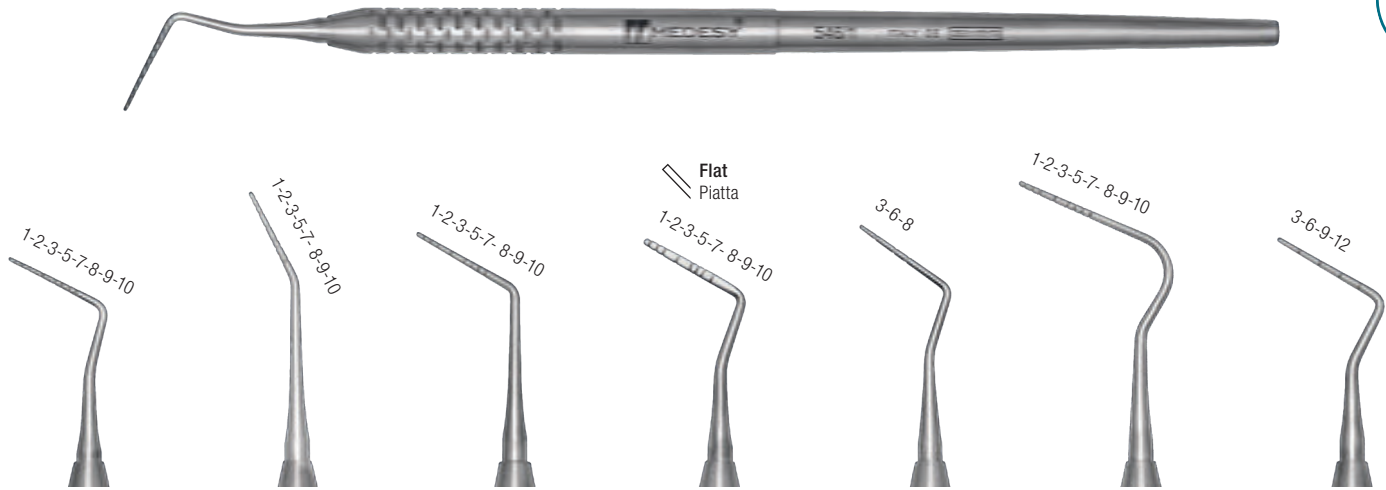

546/1
Williams

546/2
Merritt A

546/3
Merritt B

546/4
Goldman Fox

546/5
Michigan "0"

546/6
26 Glickman 26G

546/7
Mercury

The double-curved periodontal probe always ensures optimal visibility and easy handling. Available with 6 mm handle and black laser markings or with 8 mm hollow handle and blue titanium markings.

La sonda parodontale con doppia curvatura assicura sempre un'ottima visibilità e maneggevolezza. Disponibile in manico da 6 mm e tacche nere al laser, o in manico vuoto 8 mm e tacche al titanio blu.

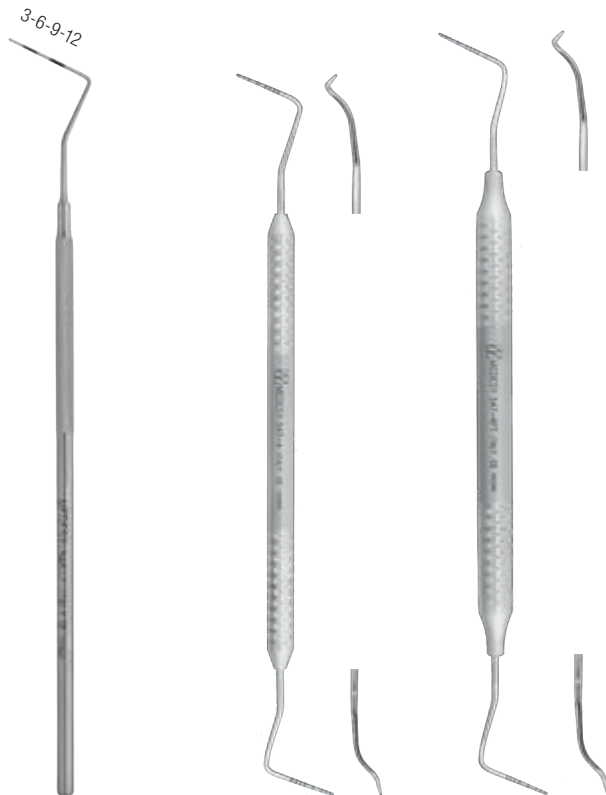

548/7FI
Delicate CP12
Handle ø 3,5 mm

547/4
Williams
Doubles

547/4 PT
Williams
Doubles



Shown Williams Doubles

PERIODONTAL PROBES DOUBLE-ENDED

SONDE PARODONTALI DOPPIE



563/1
Who
CP15



563/2
Who
CP12



563/3
Who
Williams



568/1
Williams
Goldman-Fox

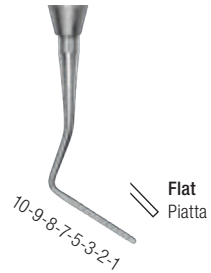
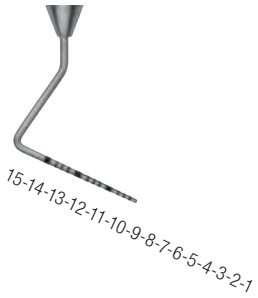

569/1
Nabers 1N



569/2
Nabers 2N



569/2 COL
Nabers 2N
Color coded



12-9-6-3

“ MEDESY IN SPOT

NABERS PROBES: used to evaluate furcation areas.

SONDE NABERS: utilizzate per analizzare le aree delle forcazioni.

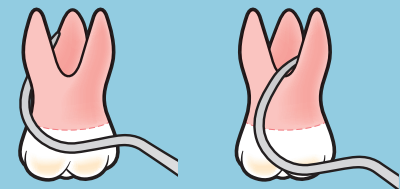

DIAGNOSTIC / DIAGNOSTICA

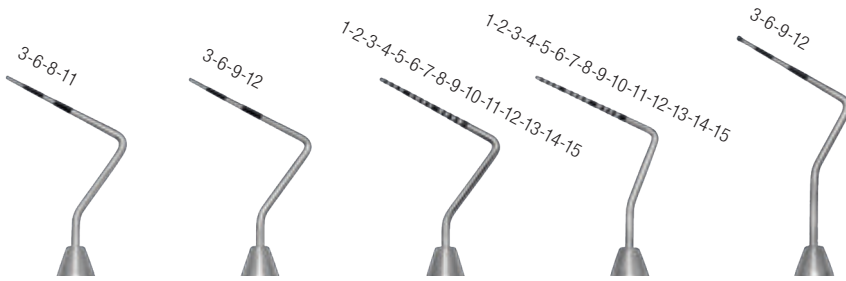

570/1 CP11 Explorer N. 23	570/2 CP12 Explorer N. 23	570/3 CP15 Explorer N. 23	570/4 CP15 Explorer N. 17	570/5 CP12S Explorer N. 23
--	--	--	--	---



571/16 Michigan "0" Explorer N. 16	571/23 Michigan "0" Explorer N. 23
---	---

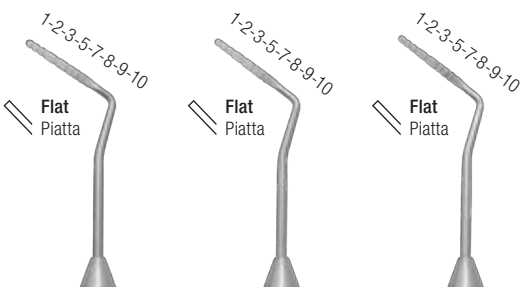

566/16 Goldman-Fox Explorer N. 16	566/17 Goldman-Fox Explorer N. 17	566/23 Goldman-Fox Explorer N. 23
--	--	--



567/3 Williams Explorer N. 3	567/16 Williams Explorer N. 16	567/17 Williams Explorer N. 17	567/23 Williams Explorer N. 23
---	---	---	---





NEW LINE OF GRACEY CURETTES

NUOVA LINEA DI CURETTE GRACEY

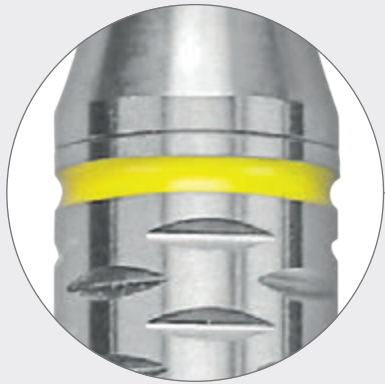

COLOUR CODED

All the standard curettes are available plus two additional lines with different handle and colour-coded for easy identification.

CODICE COLORE

La gamma di curette standard è completata da due nuove linee con manico diverso e codice colore per una facile identificazione.

A SUPERIOR CURETTE

Using a special new steel alloy MEDESYS has managed to create a superior curette with even sharper edges; greater hardness and excellent wear resistance of the blade guarantee for a more efficient and durable scaling even in case of intensive use.

UNA CURETTE SUPERIORE

Utilizzando una nuova speciale lega d'acciaio MEDESYS è riuscita a creare una curette di altissima qualità con affilatura di grado superiore; la maggior durezza e quindi resistenza all'usura della lama garantisce un curettage più efficace e duraturo nel tempo anche in caso di utilizzo molto intenso.

ARROW-SHAPE INDICATOR

An arrow-shape indicator on the handle shows the sharp side.

INDICATORE PARTE AFFILATA

Una piccola freccia sul manico indica il lato affilato della punta.

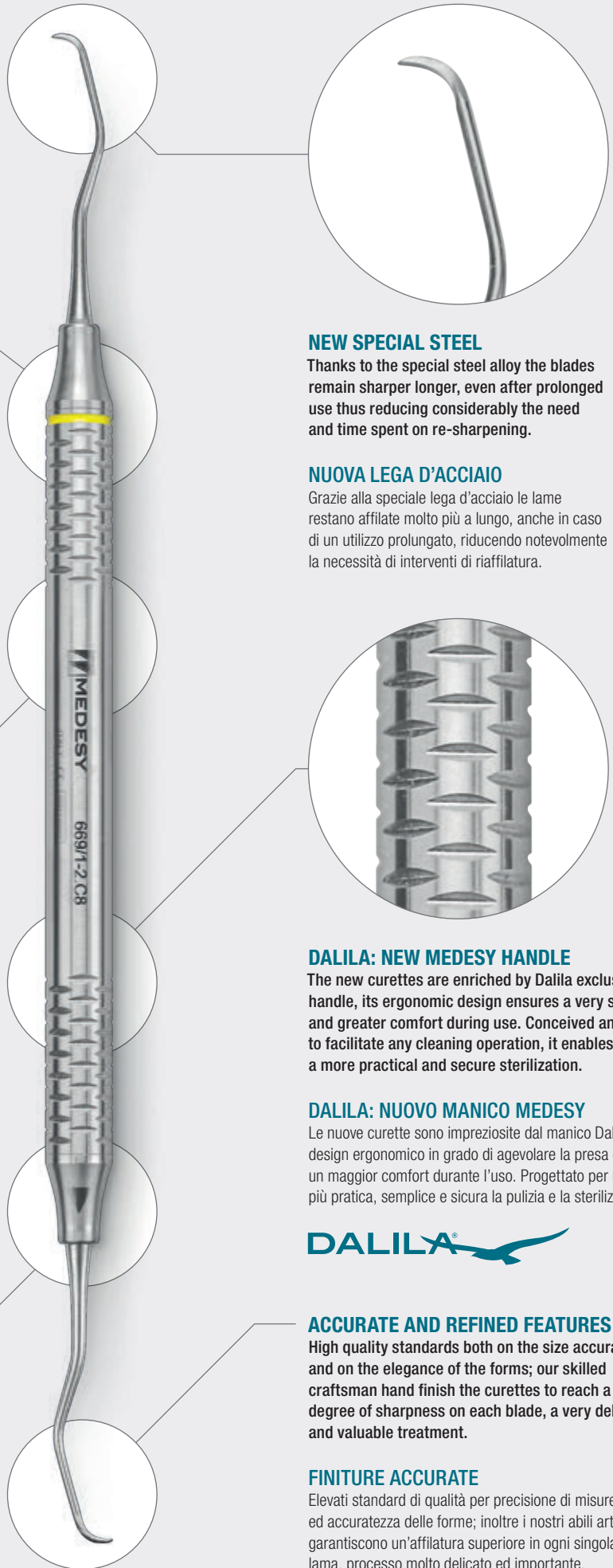
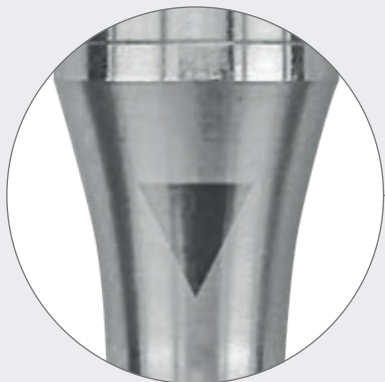

NEW SPECIAL STEEL

Thanks to the special steel alloy the blades remain sharper longer, even after prolonged use thus reducing considerably the need and time spent on re-sharpening.

NUOVA LEGA D'ACCIAIO

Grazie alla speciale lega d'acciaio le lame restano affilate molto più a lungo, anche in caso di un utilizzo prolungato, riducendo notevolmente la necessità di interventi di riaffilatura.

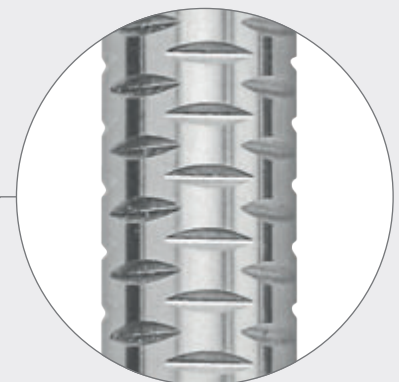

DALILA: NEW MEDESYS HANDLE

The new curettes are enriched by Dalila exclusive handle, its ergonomic design ensures a very stable grip and greater comfort during use. Conceived and realized to facilitate any cleaning operation, it enables a more practical and secure sterilization.

DALILA: NUOVO MANICO MEDESYS

Le nuove curette sono impreziosite dal manico Dalila, un nuovo design ergonomico in grado di agevolare la presa e garantire un maggior comfort durante l'uso. Progettato per rendere più pratica, semplice e sicura la pulizia e la sterilizzazione.



ACCURATE AND REFINED FEATURES

High quality standards both on the size accuracy and on the elegance of the forms; our skilled craftsman hand finish the curettes to reach a superior degree of sharpness on each blade, a very delicate and valuable treatment.

FINITURE ACCURATE

Elevati standard di qualità per precisione di misure ed accuratezza delle forme; inoltre i nostri abili artigiani garantiscono un'affilatura superiore in ogni singola lama, processo molto delicato ed importante.

GRACEY CURETTES COMPARISON

CURETTE GRACEY A CONFRONTO



GRACEY CURETTES "RIGID TYPE": have a thicker and less flexible shank than standard Gracey. Used for treatments usually performed with a scaler.

GRACEY CURETTES "LONG TYPE": have a longer shank, 3mm longer than standard Gracey and enable deep reaching into the periodontal pockets.

GRACEY CURETTES "SHORT TYPE": having the same characteristics as "long type" except for the cutting end, which is shorter to allow easier sub-gingival insertion even in the deepest and narrow periodontal pockets.

GRACEY CURETTES "TIPO RIGIDO": curette con stelo più grosso e meno flessibile rispetto la Gracey tradizionale. Utili in operazioni che abitualmente richiedono l'utilizzo di scalers.

GRACEY CURETTES "TIPO LUNGO": curette con stelo più lungo di 3mm rispetto la Gracey tradizionale, con lo scopo di intervenire in profondità nelle tasche parodontali.

GRACEY CURETTES "TIPO CORTO": curette con la stessa caratteristica della "tipo lungo" con la differenza di avere la parte terminale più corta, al fine di poter intervenire nelle tasche parodontali profonde e strette.

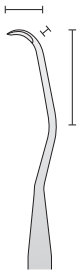

GRACEY CURETTES
GRACEY CURETTES



GRACEY CURETTES "RIGID TYPE"
GRACEY CURETTES "TIPO RIGIDO"



GRACEY CURETTES "LONG TYPE"
GRACEY CURETTES "TIPO LUNGO"

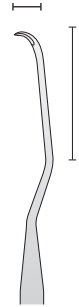

GRACEY CURETTES "SHORT TYPE"
GRACEY CURETTES "TIPO CORTO"

DALILA HANDLE OPTIONS

VARIETÀ MANICI DALILA

HL8

Hollow handle \varnothing 8 mm
Manico vuoto \varnothing 8 mm

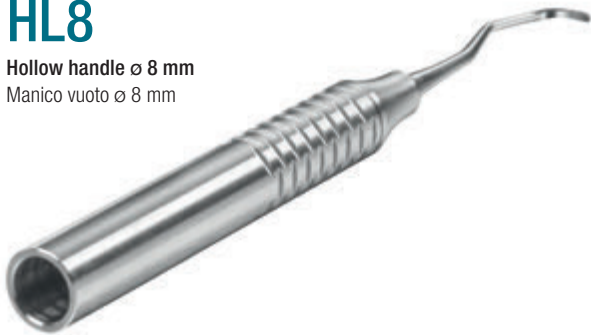

HL10

Hollow handle \varnothing 10 mm
Manico vuoto \varnothing 10 mm



C8

Hollow handle \varnothing 8 mm with color ring
Manico vuoto \varnothing 8 mm con anello colorato

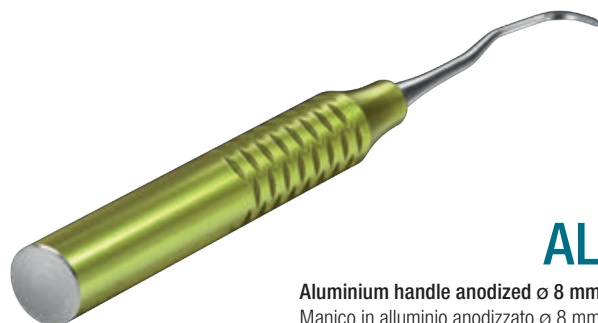

AL

Aluminium handle anodized \varnothing 8 mm
Manico in alluminio anodizzato \varnothing 8 mm





GRACEY STANDARD

GRACEY STANDARD



Single cutting edge
Affilatura singola

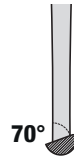

70° from shank
70° rispetto allo stelo



625/KIT.HL8
625/KIT.HL10
625/KIT.C8
625/KIT.AL

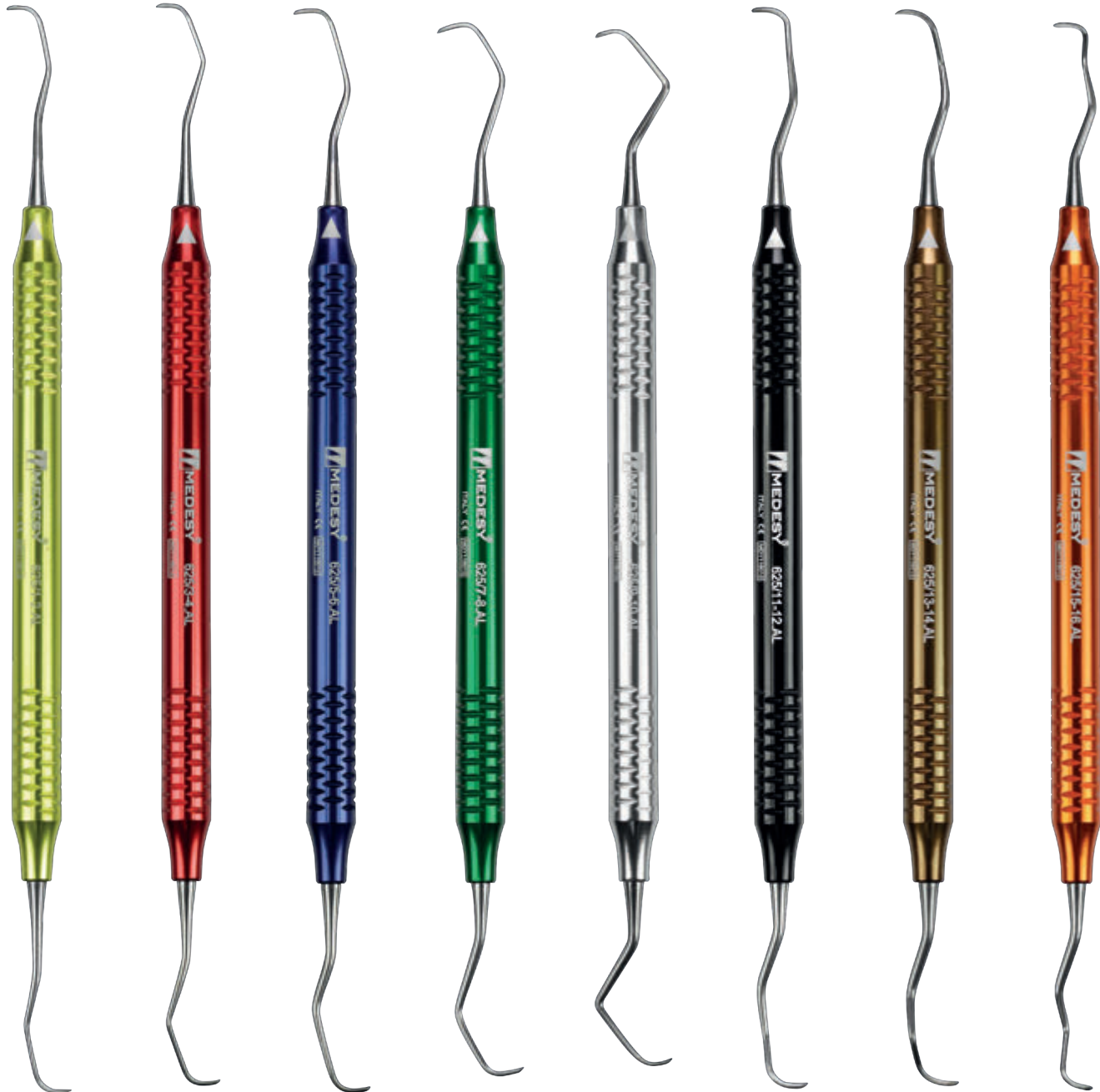

AL Aluminium handle anodized \varnothing 8 mm (as shown)
Manico in alluminio anodizzato \varnothing 8 mm (come da foto)

(1:1 scale / scala 1:1)

625/1-2.HL8	625/3-4.HL8	625/5-6.HL8	625/7-8.HL8	625/9-10.HL8	625/11-12.HL8	625/13-14.HL8	625/15-16.HL8
625/1-2.HL10	625/3-4.HL10	625/5-6.HL10	625/7-8.HL10	625/9-10.HL10	625/11-12.HL10	625/13-14.HL10	625/15-16.HL10
625/1-2.C8	625/3-4.C8	625/5-6.C8	625/7-8.C8	625/9-10.C8	625/11-12.C8	625/13-14.C8	625/15-16.C8
625/1-2.AL	625/3-4.AL	625/5-6.AL	625/7-8.AL	625/9-10.AL	625/11-12.AL	625/13-14.AL	625/15-16.AL
Anterior	Anterior	Anterior	Buccal/Lingual	Buccal/Lingual	Mesial/Premolar/Molar	Distal/Premolar/Molar	Mesial/Premolar/Molar

GRACEY RIGID TYPE
GRACEY TIPO RIGIDO



628/KIT.HL8
628/KIT.HL10
628/KIT.C8

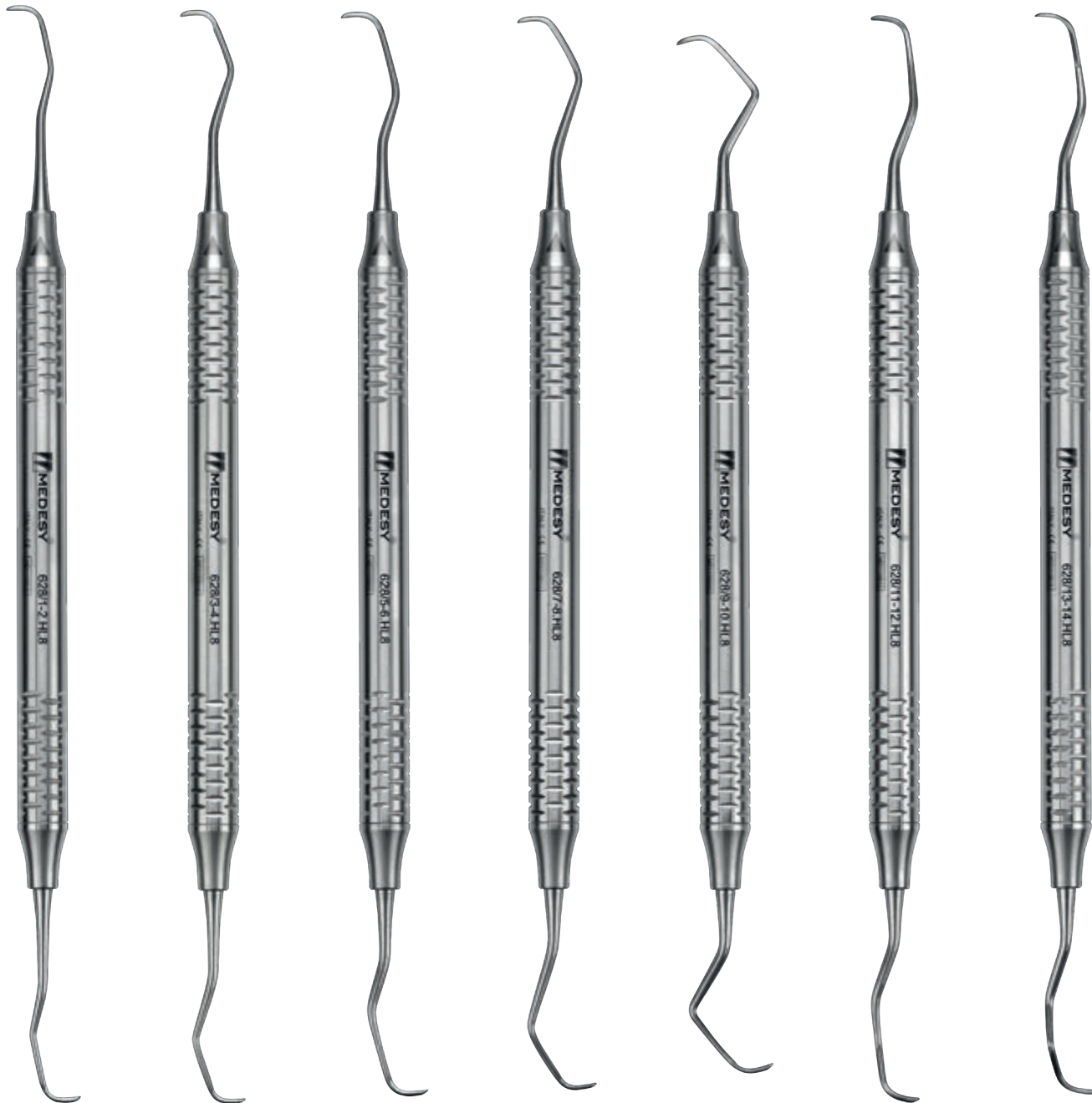

HL8 Hollow handle \varnothing 8 mm (as shown)
Manico vuoto \varnothing 8 mm (come da foto)

(1:1 scale / scala 1:1)

628/1-2.HL8

628/1-2.HL10
628/1-2.C8

Anterior

628/3-4.HL8

628/3-4.HL10
628/3-4.C8

Anterior

628/5-6.HL8

628/5-6.HL10
628/5-6.C8

Anterior

628/7-8.HL8

628/7-8.HL10
628/7-8.C8

Buccal/Lingual

628/9-10.HL8

628/9-10.HL10
628/9-10.C8

Buccal/Lingual

628/11-12.HL8

628/11-12.HL10
628/11-12.C8

Mesial/Premolar/Molar

628/13-14.HL8

628/13-14.HL10
628/13-14.C8

Distal/Premolar/Molar



PERIODONTAL / PARODONTOLOGIA



669/KIT.HL8
669/KIT.HL10
669/KIT.C8

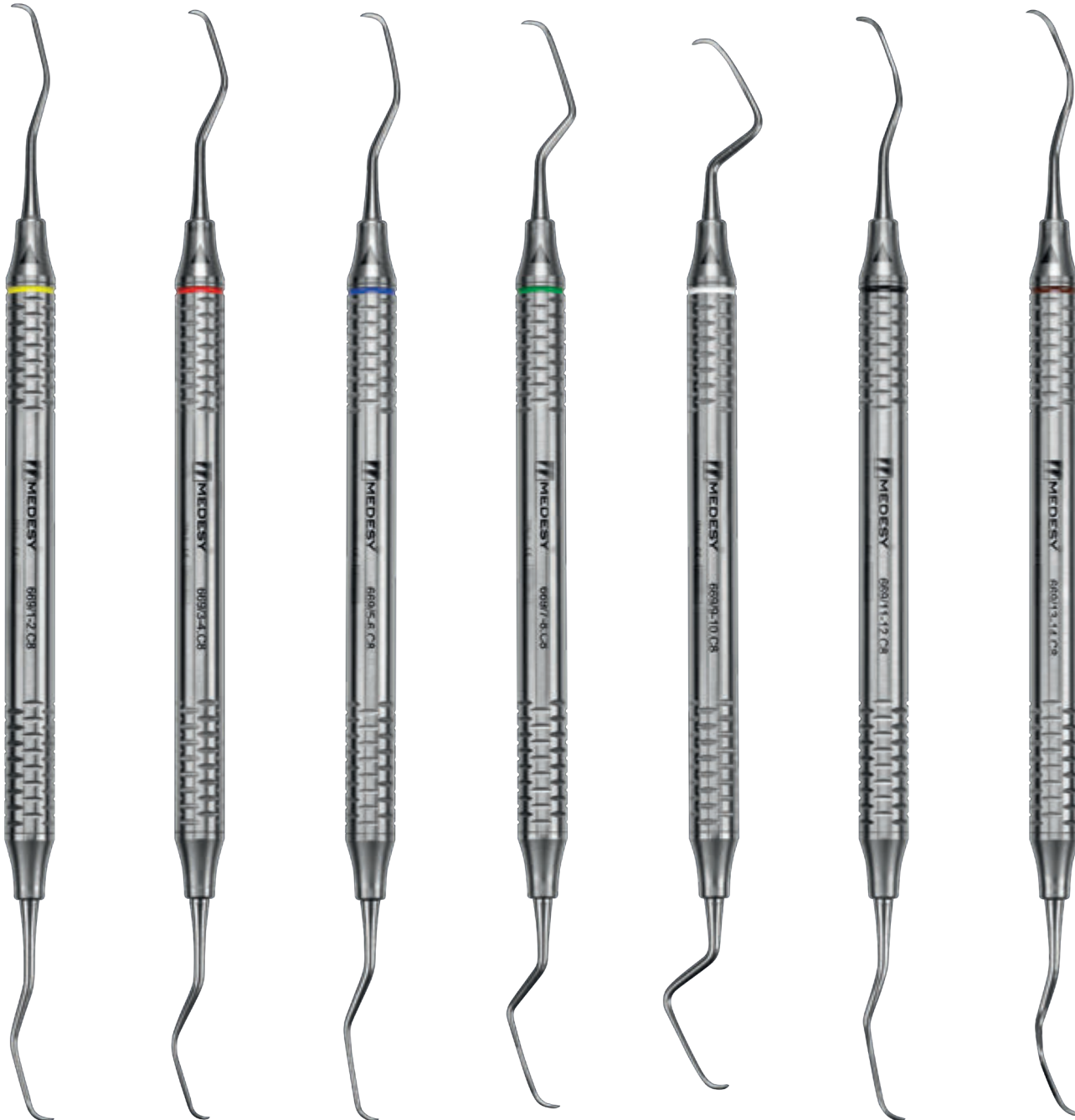

C8 Hollow handle \varnothing 8 mm with color ring (as shown)
Manico vuoto \varnothing 8 mm con anello colorato (come da foto)

(1:1 scale / scala 1:1)

669/1-2.HL8
669/1-2.HL10

669/1-2.C8

Anterior

669/3-4.HL8
669/3-4.HL10

669/3-4.C8

Anterior

669/5-6.HL8
669/5-6.HL10

669/5-6.C8

Anterior

669/7-8.HL8
669/7-8.HL10

669/7-8.C8

Buccal/Lingual

669/9-10.HL8
669/9-10.HL10

669/9-10.C8

Buccal/Lingual

669/11-12.HL8
669/11-12.HL10

669/11-12.C8

Mesial/Premolar/Molar

669/13-14.HL8
669/13-14.HL10

669/13-14.C8

Distal/Premolar/Molar

GRACEY LONG TYPE
GRACEY TIPO LUNGO



679/KIT.HL8
679/KIT.HL10
679/KIT.C8

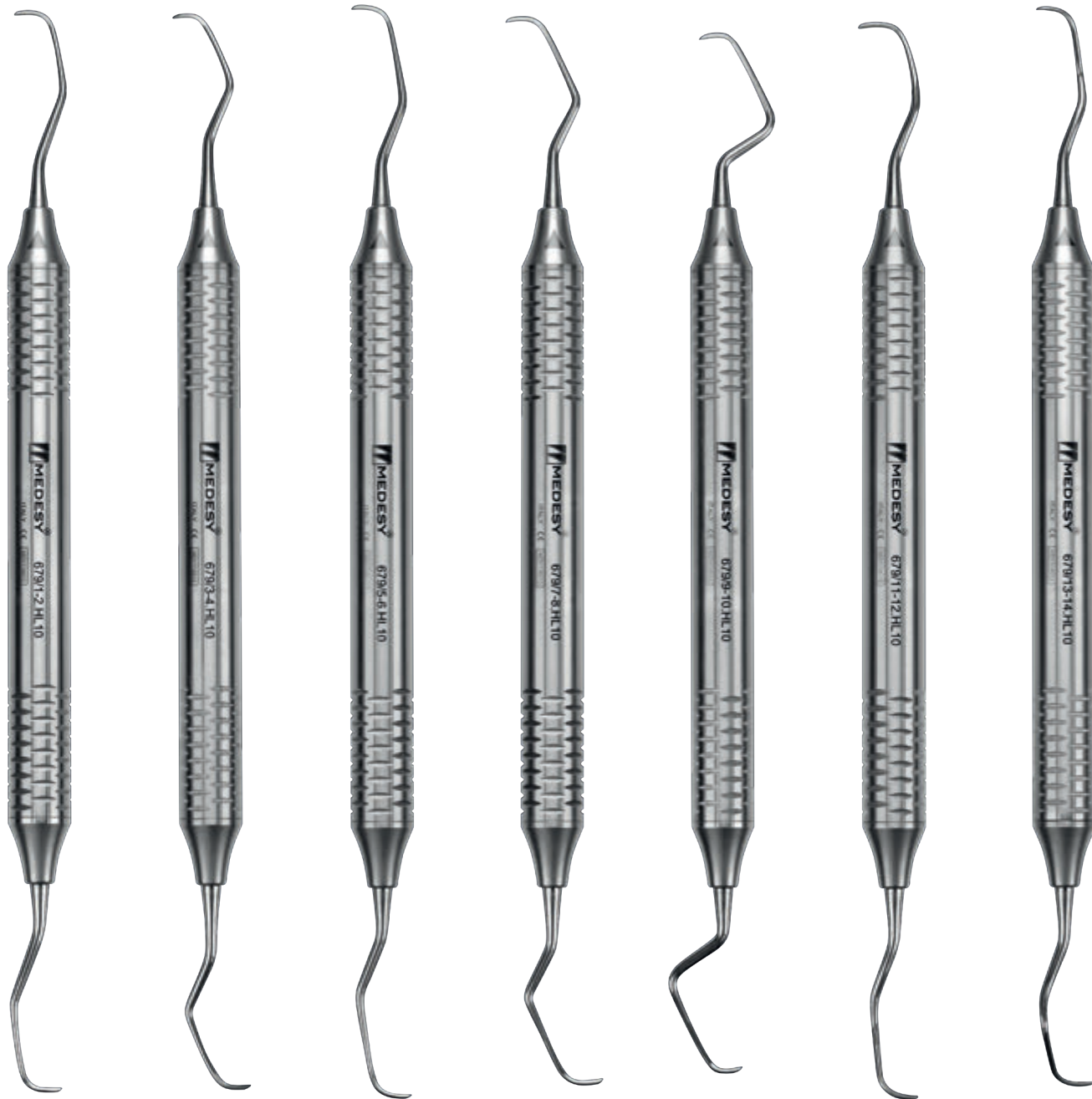

HL10 Hollow handle \varnothing 10 mm (as shown)
Manico vuoto \varnothing 10 mm (come da foto)

(1:1 scale / scala 1:1)

679/1-2.HL8
679/1-2.HL10
679/1-2.C8
Anterior

679/3-4.HL8
679/3-4.HL10
679/3-4.C8
Anterior

679/5-6.HL8
679/5-6.HL10
679/5-6.C8
Anterior

679/7-8.HL8
679/7-8.HL10
679/7-8.C8
Buccal/Lingual

679/9-10.HL8
679/9-10.HL10
679/9-10.C8
Buccal/Lingual

679/11-12.HL8
679/11-12.HL10
679/11-12.C8
Mesial/Premolar/Molar

679/13-14.HL8
679/13-14.HL10
679/13-14.C8
Distal/Premolar/Molar



PERIODONTAL / PARODONTOLOGIA



UNIVERSAL CURETTES

CURETTES UNIVERSALI



Double cutting edge
Affilatura doppia



90° from shan
90° rispetto allo stelo

90°



626/2.HL8

Langer 1/2

Mandibular posterior



626/4.HL8

Langer 3/4

Maxillary posterior



626/6.HL8

Langer 5/6

Mandibular and
maxillary anterior



627/2.HL8

Columbia 2R/2L

Anterior



627/4.HL8

Columbia 4R/4L

Posterior



627/14.HL8

Columbia 13/14

Universal



623/412.HL8

411/412

Universal



623/414.HL8

413/414

Universal



624/2.HL8

Goldman-Fox 2

Anterior



624/3.HL8

Goldman-Fox 3

Posterior



624/4.HL8

Goldman-Fox 4

Posterior





629/14.HL8
Mc Call 13/14
Posterior



629/15.HL8
Mc Call 13S/14S
Pointed



629/17.HL8
Mc Call 17/18
Narrow for molars



629/19.HL8
Mc Call 17S/18S
Narrow for molars



629/20.HL8
Mc Call 19/20



623/1.HL8
Barnhart 1/2
Posterior



623/5.HL8
Barnhart 5/6
Posterior



656/1.HL8
ME-1



633/17.HL8
Indiana University 17/18
Posterior



633/8.HL8
Younger-Good 7/8





622/1-2.HL8
Debridement N. 1-2
Buccal/Lingual

622/3-4.HL8
Debridement N. 3-4
Mesial/Distal

622/5-6.HL8
Debridement N. 5-6
Mesial/Distal

622/7-8.HL8
Debridement N. 7-8
Mesial/Distal

DEBRIDEMENT:
Used to clean up after
the ultrasonic scaler.
Usate per ripulire dopo
il detartraggio ad ultrasuoni.



632/1.HL8
De Marco 1
Anterior

632/2.HL8
De Marco 2
Anterior



620/1.HL8
Kramer N. 1

620/2.HL8
Kramer N. 2

620/3.HL8
Kramer N. 3

KRAMER:
Perio-Curettes, more rigid for removal
of heavy subgingival deposits.
Perio-Curettes, più rigide per rimuovere
grossi depositi subgengivali.



SCALERS
SCALERS



Double cutting edge
Affilatura doppia



90° from shank, pointed
90° rispetto allo stelo, a punta

90°



640/24.HL8
204



640/6.HL8
204 N
As 204 but longer
Come 204 ma più lungo



640/1.HL8
204 S
Posterior



640/7.HL8
204 S Thin
As 204 S but thinner
Come 204 ma più fino



640/5.HL8
204 SD
Posterior/Distal



640/23.HL8
Ball 2-3



640/107.HL8
Cattoni 107-108
Posterior



640/3.HL8
Cl 2/3



640/2.HL8
Crane-Kaplan CK6



640/13.HL8
Taylor 2/3





651/8.HL8
Hygienist H5



651/9.HL8
Jaquette H3-H4



651/11.HL8
Hygienist H6-H7
Universal anterior
and premolar



651/12.HL8
Hygienist H6-H7 Thin
As H6-H7 but thinner
Come H6-H7 ma più fino



653/U15.HL8
Towner U15



651/U15-30.HL8
Towner U15
Jaquette J30
Anterior

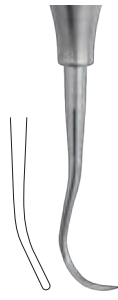

651/U15-33.HL8
Towner U15
Jaquette J33
Anterior



651/H5-30.HL8
Hygienist H5
Jaquette J30
Anterior



651/H5-33.HL8
Hygienist H5
Jaquette J33
Anterior





Double cutting edge
Affilatura doppia

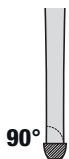

90° from shank, pointed
90° rispetto allo stelo, a punta

90°



651/30-33.HL8
Jaquette
Anterior



651/31-32.HL8
Jaquette
Posterior



651/34-35.HL8
Jaquette
Posterior



651/37-38.HL8
Posterior



624/1.HL8
Goldman-Fox 1



624/21.HL8
Goldman-Fox 21



624/00.HL8
Morse 0/00
Anterior



639/23.HL8
Swiss type Universal
Posterior



639/24.HL8
Swiss type
Rounded



629/12.HL8
Mc Call 11/12



629/13.HL8
Mc Call 11A/12A





621/128.HL8
Nebraska 128
Anterior



(1:1 scale / scala 1:1)

6166
Silicone rings for organizing and identifying instruments. Box of 120 pcs in assorted colors. Anelli in silicone per organizzare e identificare gli strumenti. Scatola da 120 pz in colori assortiti.

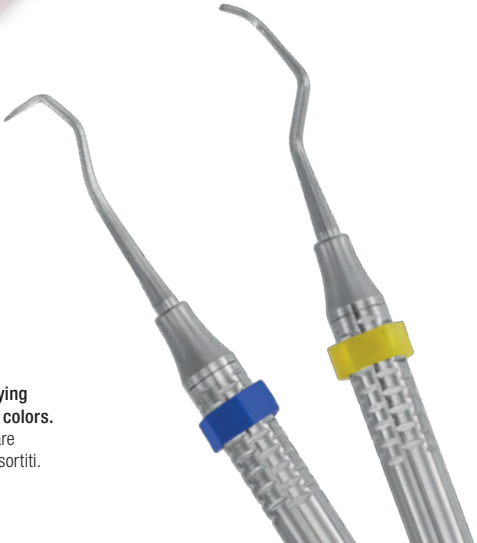

PERIODONTAL HOES
SCALPELLI PARODONTALI



550/6-7.HL8

Orban 6-7

Mesial/Distal

550/8-9.HL8

Orban 8-9

Buccal/Lingual



551/1.HL8

Hoe – Anterior

Labial/Lingual

551/3.HL8

Hoe – Lateral

Buccal/Lingual

551/5.HL8

Hoe – Posterior

Mesial/Distal



624/5.HL8

Goldman-Fox 5

Buccal/Lingual

624/6.HL8

Goldman-Fox 6

Mesial/Distal



Sharpening process
Processo di affilatura



(1:1 scale / scala 1:1)

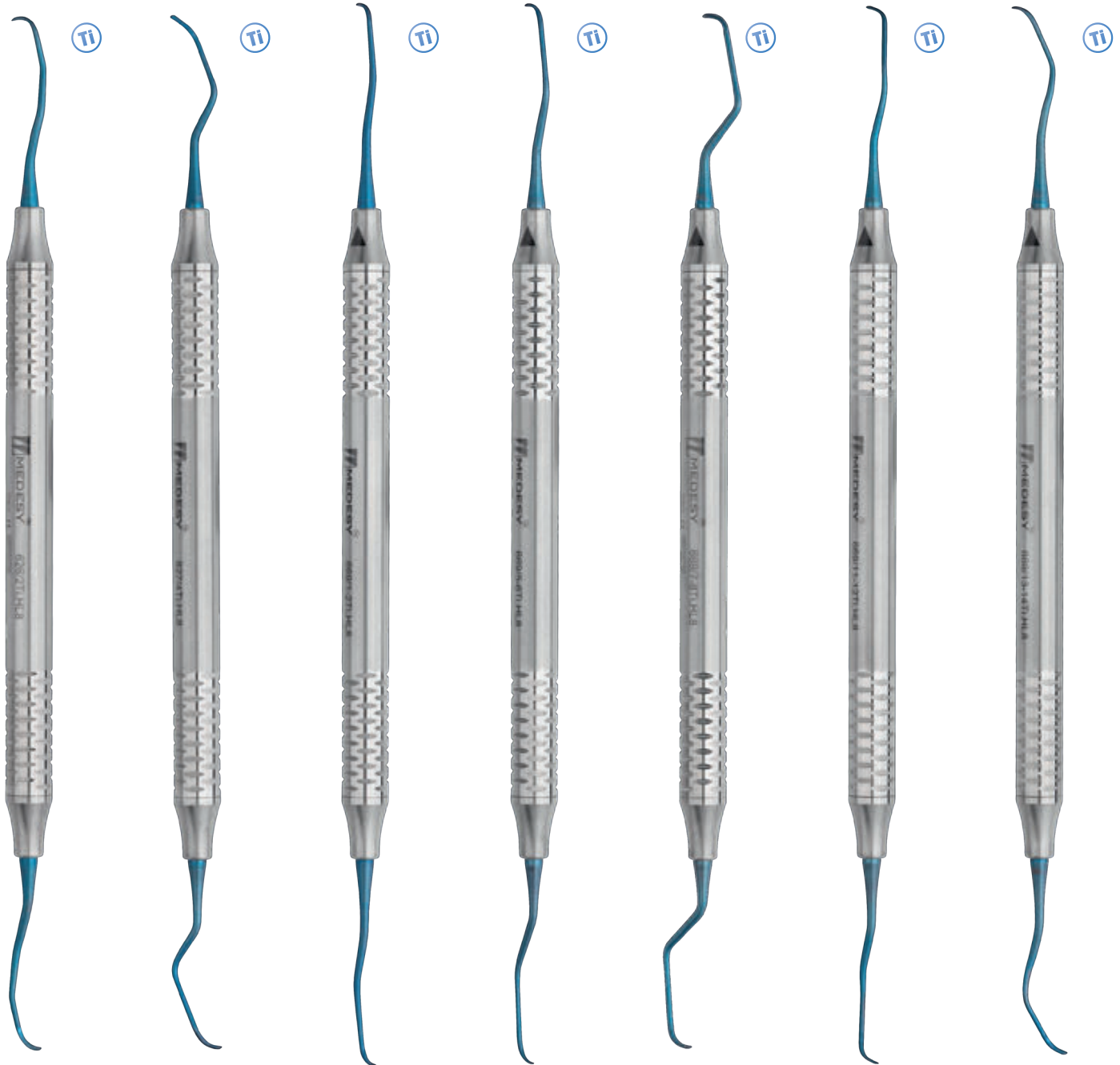

626/2Ti.HL8
626/2Ti.HL10

Langer 1/2

Titanium
Titanio

627/4Ti.HL8
627/4Ti.HL10

Columbia 4R/4L

Titanium
Titanio

669/1-2Ti.HL8
669/1-2Ti.HL10

Gracey Short type

Titanium
Titanio

669/5-6Ti.HL8
669/5-6Ti.HL10

Gracey Short type

Titanium
Titanio

669/7-8Ti.HL8
669/7-8Ti.HL10

Gracey Short type

Titanium
Titanio

669/11-12Ti.HL8
669/11-12Ti.HL10

Gracey Short type

Titanium
Titanio

669/13-14Ti.HL8
669/13-14Ti.HL10

Gracey Short type

Titanium
Titanio

1671/3

Perimplantite Kit
Kit Perimplantite

Content / Contenuto:

548/4 PT	Probe CP15
627/4Ti.HL8	Curette Columbia 4R/4L Titanium
651/11Ti.HL8	Scaler H6-H7 Titanium
669/5-6Ti.HL10	Gracey short type Titanium
669/7-8Ti.HL10	Gracey short type Titanium
669/11-12Ti.HL10	Gracey short type Titanium
669/13-14Ti.HL10	Gracey short type Titanium
980/9	Gammafix tray Doi

(1:1 scale / scala 1:1)



640/1Ti.HL8
640/1Ti.HL10

Scaler 204 S

Titanium
Titanio

640/5Ti.HL8
640/5Ti.HL10

Scaler 204 SD

Titanium
Titanio

651/11Ti.HL8
651/11Ti.HL10

Hygienist H6/H7

Titanium
Titanio



KIT PERIMPLANTITE

The bacterial aggression observed on the neck portion of the implants is similar to the bacterial aggression observable at the muco-gingival junction of the tooth. The stainless steel instruments may contaminate the titanium made implants while plastic instruments do not fully remove the failing tissues around the implant. Hence the need of using instruments made of titanium, the unique solution for a real efficient and fully safe handling on and close to the implants sites. Blue colour for a simple and fast identification of titanium tips, from standard gray of stainless steel. **MEDESYS Perimplantite kit includes 4 curettes "Short Type"; 1 curette Columbia; 2 Scalers; 1 periodontal probe.**

L'aggressione batterica osservata nel collo degli impianti è simile a quella presente a livello della giunzione muco gengivale del dente. Gli strumenti in acciaio possono contaminare il titanio degli impianti, mentre quelli in plastica non sono in grado di rimuovere in modo efficiente la parte in oggetto. Da qui la necessità di usare strumenti in titanio, la soluzione sicuramente più adeguata per una gestione del problema efficiente ed in piena sicurezza in prossimità degli impianti. Il colore blu delle punte, serve per identificare in modo semplice e sicuro il titanio impiegato, rispetto al tradizionale acciaio.

Il kit Perimplantite di MEDESYS è composto da: 4 curettes "Tipo Corto"; 1 curette Columbia; 2 scaler; 1 sonda parodontale.

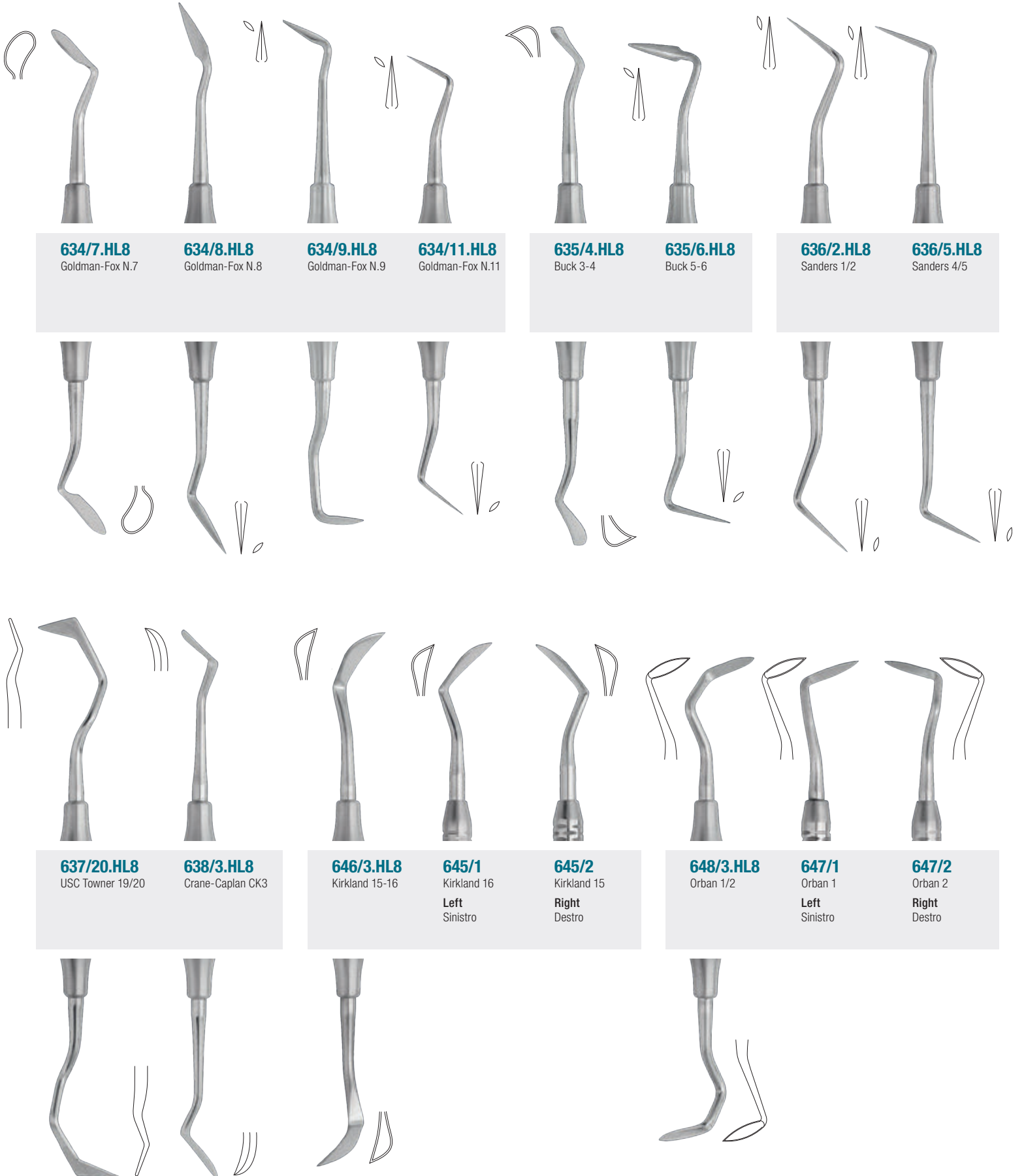

634/7.HL8

Goldman-Fox N.7

634/8.HL8

Goldman-Fox N.8

634/9.HL8

Goldman-Fox N.9

634/11.HL8

Goldman-Fox N.11

635/4.HL8

Buck 3-4

635/6.HL8

Buck 5-6

636/2.HL8

Sanders 1/2

636/5.HL8

Sanders 4/5

637/20.HL8

USC Towner 19/20

638/3.HL8

Crane-Caplan CK3

646/3.HL8

Kirkland 15-16

645/1

Kirkland 16

Left
Sinistro

645/2

Kirkland 15

Right
Destro

648/3.HL8

Orban 1/2

647/1

Orban 1

Left
Sinistro

647/2

Orban 2

Right
Destro

PERIODONTAL FILES

LIME PARODONTALI



(1:1 scale / scala 1:1)

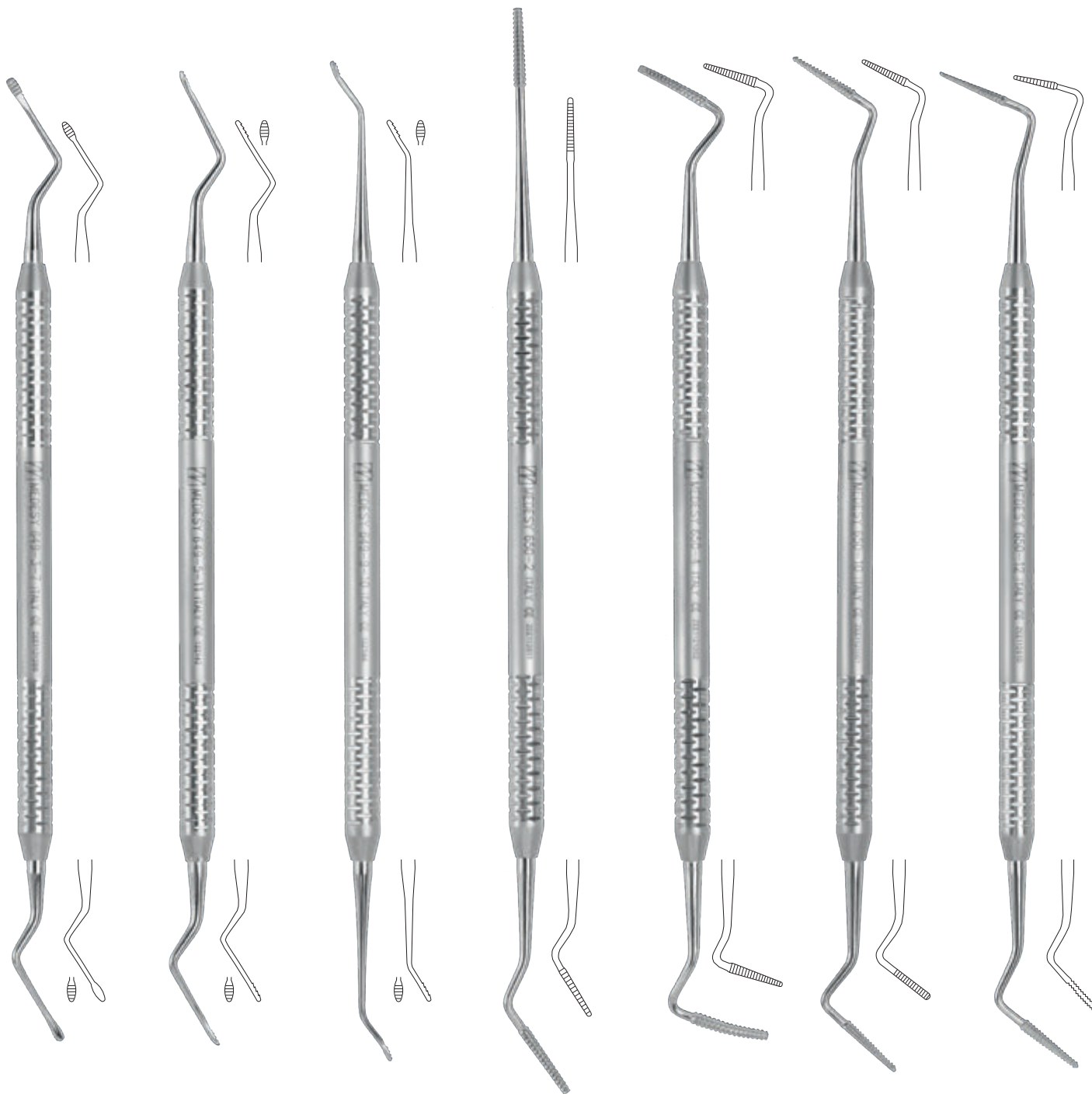

649/3-7
649/3-7.HL8
Hirschfeld N. 3

649/5-11
649/5-11.HL8
Hirschfeld N. 5

649/9-10
649/9-10.HL8
Hirschfeld N. 9

650/2
650/2.HL8
Buck 11/12

650/4
650/4.HL8
Schluger 9/10
Curved

650/10
650/10.HL8
Sugarman 3S/4S
Buccal – Lingual

650/12
650/12.HL8
Sugarman 1S/2S
Mesial – Distal



PERIODONTAL / PARODONTOLOGIA

(1:1 scale / scala 1:1)

1,8 mm

2,0 mm

2,2 mm



642/1
642/1.HL8
Fedi N. 1

642/2
642/2.HL8
Fedi N. 2

643/3
643/3.HL8
Ochsenbein N. 3

642/3
642/3.HL8
Ochsenbein N. 4

643/37
643/37.HL8
Rhodes
Back-Action 36/37

643/13.HL8
Kirkland 13K

643/14.HL8
Kirkland 13K-TG

3,0 mm

3,0 mm



1021/1

Left
Sinistra



1021/2

Right
Destra



645/3
645/3.HL8
TG

641/3
641/3.HL8
TG-0

630/1
Zerfing

**Pocket marking
tweezers**
Pinzette
segnatasche

1021/1
Crane-Kalplan
Left
Sinistra

1021/2
Crane-Kalplan
Right
Destra



SHARP CURETTE (CROSS SECTION) / CURETTE TAGLIENTE (SEZIONE)

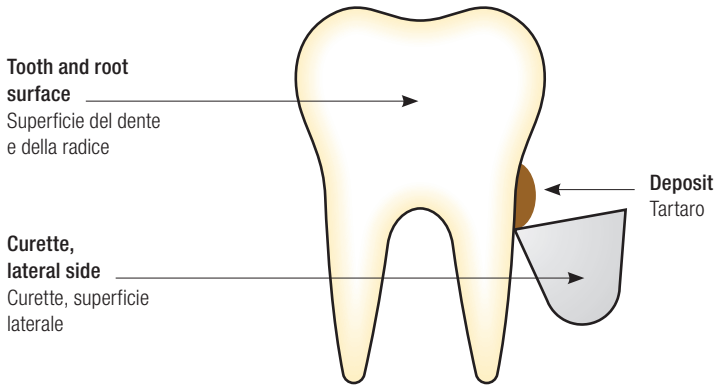

SHARP INSTRUMENTS REMOVE ENTIRE DEPOSIT

STRUMENTI TAGLIANTI RIMUOVONO I DEPOSITI

DULL CURETTE (CROSS SECTION) / CURETTE SMUSSATA (SEZIONE)

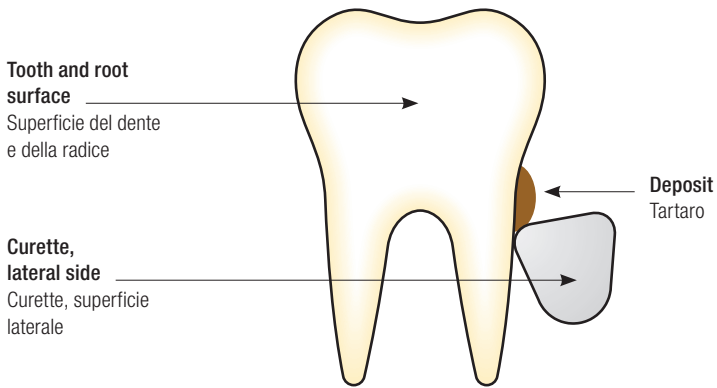

DULL INSTRUMENTS ONLY "BURNISH" OR REMOVE PART OF A DEPOSIT

STRUMENTI SMUSSATI "LISCIANO" OVVERO RIMUOVONO I DEPOSITI SOLO IN PARTE

6169

Sharpening tester, pcs 4
Barretta test affilatura, pz 4



“ MEDESY IN SPOT

HOW TO SHARPEN A GRACEY?

After lubricating the stone with a specific sharpening oil, lay the tip of the curette on the upper part of the stone by angling the handle at 60°/70° to the stone.

To start the sharpening move the blade forwards and backwards over the stone through regular movements, but apply pressure when pushing the instrument backwards.

COME AFFILARE UNA GRACEY?

Dopo aver lubrificato la pietra con l'apposito olio, si procede ponendo la punta della curette nella parte alta della pietra formando un angolo di circa 60°/70°. Dopodiché con dei brevi movimenti regolari dall'alto verso il basso inizia l'operazione di affilatura, ricordiamoci che la pressione della mano si esercita solamente nel movimento dall'alto verso il basso.

”

SHARPENING STONES

PIETRE PER AFFILARE



1200

Arkansas extra fine
mm 3/6×30×100

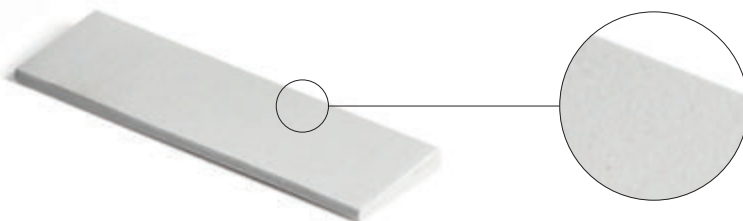

Arkansas extra fine, white
Pietra Arkansas grana extra fine, bianco

1202

India medium
mm 3/10×45×100

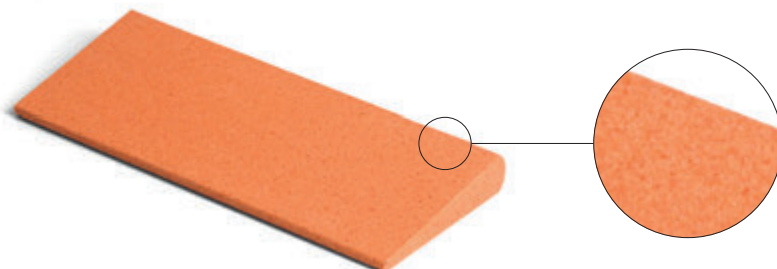

India medium, red
India grana media, rosso

1204

Natural stone
mm 10×30×100

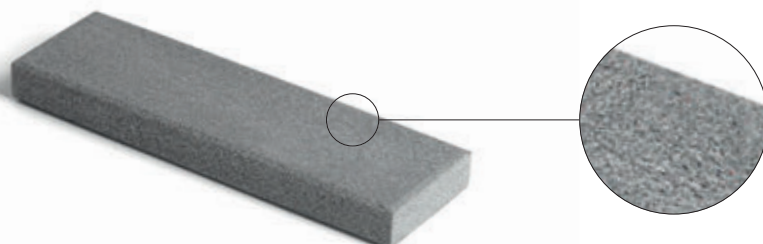

Tiger fine natural stone, use with water
Pietra naturale grana fine tipo Tiger, utilizzare con acqua

1208

Arkansas extra fine
ø mm 10×100



Arkansas extra fine, white
Pietra Arkansas grana extra fine, bianco

1210

Arkansas extra fine conical
ø mm 3/10×100



Arkansas extra fine, white
Pietra Arkansas grana extra fine, bianco

1201

Sharpening oil, 50 ml
Olio per affilatura, 50 ml



Medesy's pre-sharpening oil prevents damaging tips and keeps stones free from metal residual

Olio pre-affilatura di Medesy, agevola l'affilatura riducendo rischi, mantenendo pulite le pietre da residui metallici



KIT PERIODONTAL CLASSIC

KIT STRUMENTARIO PARODONTALE CLASSICO

1671/1

Kit periodontal classic
Kit strumentario parodontale classic

Content / Contenuto:

1124	Tweezer Meriam
1200	Sharpening stone Arkansas
4905/8	Handle with mirror N. 5
548/4 PT	Probe CP15
625/5-6.HL8	Gracey curette
625/7-8.HL8	Gracey curette
625/11-12.HL8	Gracey curette
625/13-14.HL8	Gracey curette
633/8.HL8	Curette Younger-Good
651/11.HL8	Scaler H6-H7
980/9	Gammatrix tray Doi



KIT PROPHYLAXIS CLASSIC

KIT IGIENE CLASSICO

1671/6

Kit prophylaxis classic
Kit igiene classico

Content / Contenuto:

625/5-6.HL8	Gracey curette
625/7-8.HL8	Gracey curette
625/11-12.HL8	Gracey curette
625/13-14.HL8	Gracey curette
640/1.HL8	Scaler 204S
978	Gammatrix tray Un



KIT PERIODONTAL ADVANCED

KIT STRUMENTARIO PARODONTALE ADVANCED



1671/2

Kit periodontal Advanced
Kit parodontale Advanced

Content / Contenuto:

1021/1	Pocket marking tweezer
1021/2	Pocket marking tweezer
1200	Sharpening stone Arkansas
3512	Scissor Iris Curved
548/4 PT	Probe CP15
633/8.HL8	Curette Younger-Good
634/7.HL8	Periodontal knife Goldman-Fox N. 7
634/9.HL8	Periodontal knife Goldman-Fox N. 9
634/11.HL8	Periodontal knife Goldman-Fox N. 11
651/U15-33.HL8	Scaler Towner-Jaquette
669/1-2.HL8	Gracey curette short type
669/5-6.HL8	Gracey curette short type
669/7-8.HL8	Gracey curette short type
669/11-12.HL8	Gracey curette short type
669/13-14.HL8	Gracey curette short type
851/HP3	Periosteal HP3
882	Periosteal Molt N. 9
981/19	Gammatrix tray Quatri



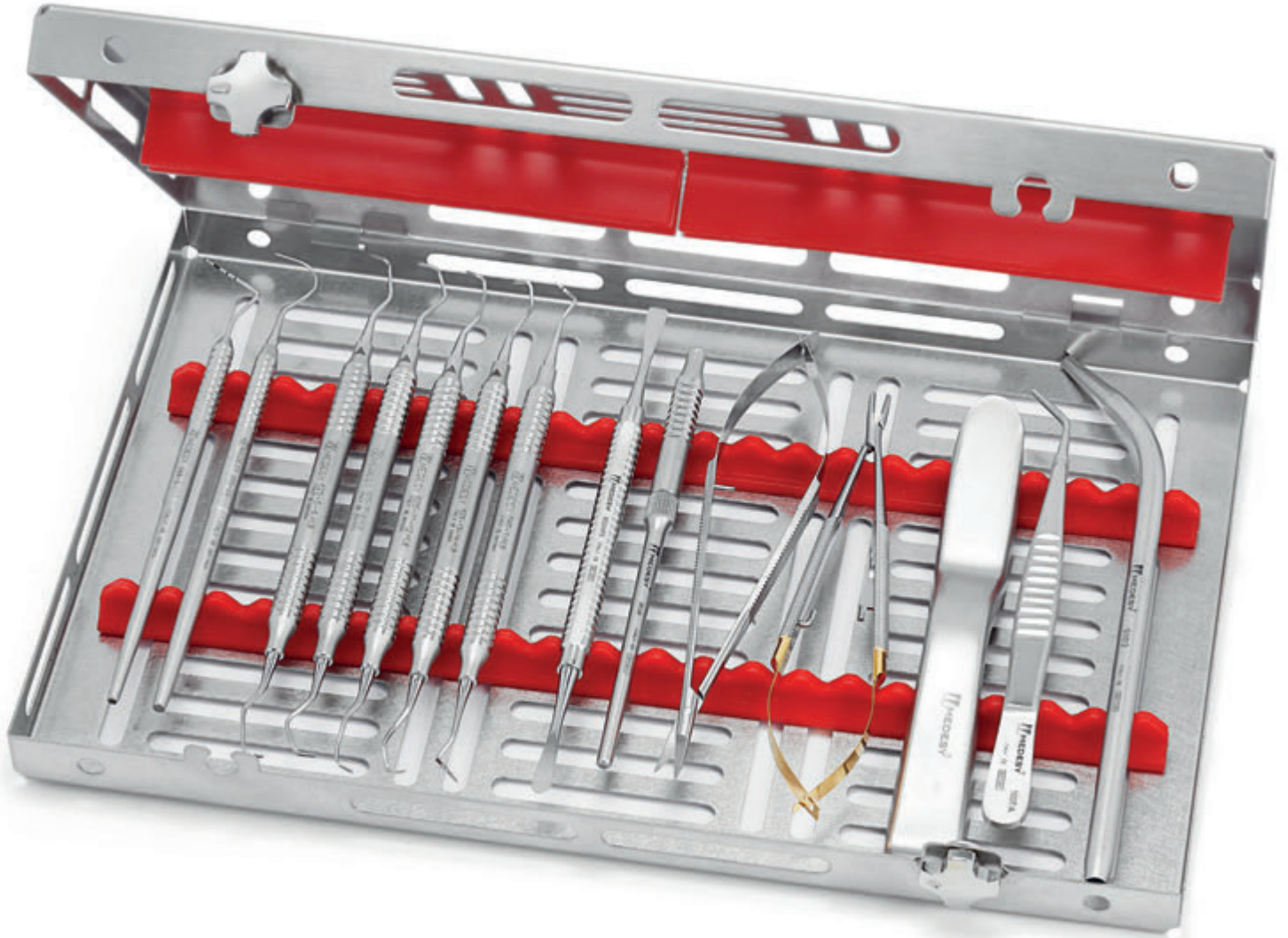

1953/KIT

Kit periodontal surgery
Kit per chirurgia parodontale

Content / Contenuto:

1007/A	De Bakey atraumatic tweezer
1922/A-TC	Needle holder Castroviejo 140 mm
3628	Micro surgical scissor spring action
3638	Handle for micro blades
548/5	Probe WHO
555/23	Explorer N. 23
625/5-6.HL8	Gracey curette
625/7-8.HL8	Gracey curette
625/11-12.HL8	Gracey curette
625/13-14.HL8	Gracey curette
640/1.HL8	Scaler 204 S
852/HP3	Periosteal HP3
907	Retractor Minnesota University
910/3	Suction tube
981/20	Gammatrix tray Cinc

Content can be changed upon request
Su richiesta il contenuto può essere cambiato



1951/KIT

Kit periodontal surgery

Kit per chirurgia parodontale

Content / Contenuto:

1040/0,6-0Y	Periodontal tweezer Gerald
1925/B-TC	Needle holder Crile-Ryder 150 mm
3525/TC	Scissor La Grange
3633	Scalpel handle
3638	Handle for micro blades
4865	Endo gun straight
4905/8 + N. 5	Mirror handle + Mirror N. 5
4908/P	Micro mirror
523/1	Plugger MT1
660/1	Bone curette Hemingway N. 1
661/87	Bone curette Lucas N. 87
882	Periosteal Molt N. 9
886	Retractor Senn-Miller
910/3	Suction tube
920/2	Retractor Gillies
981/20	Gammatrix tray Cinc

Content can be changed upon request

Su richiesta il contenuto può essere cambiato



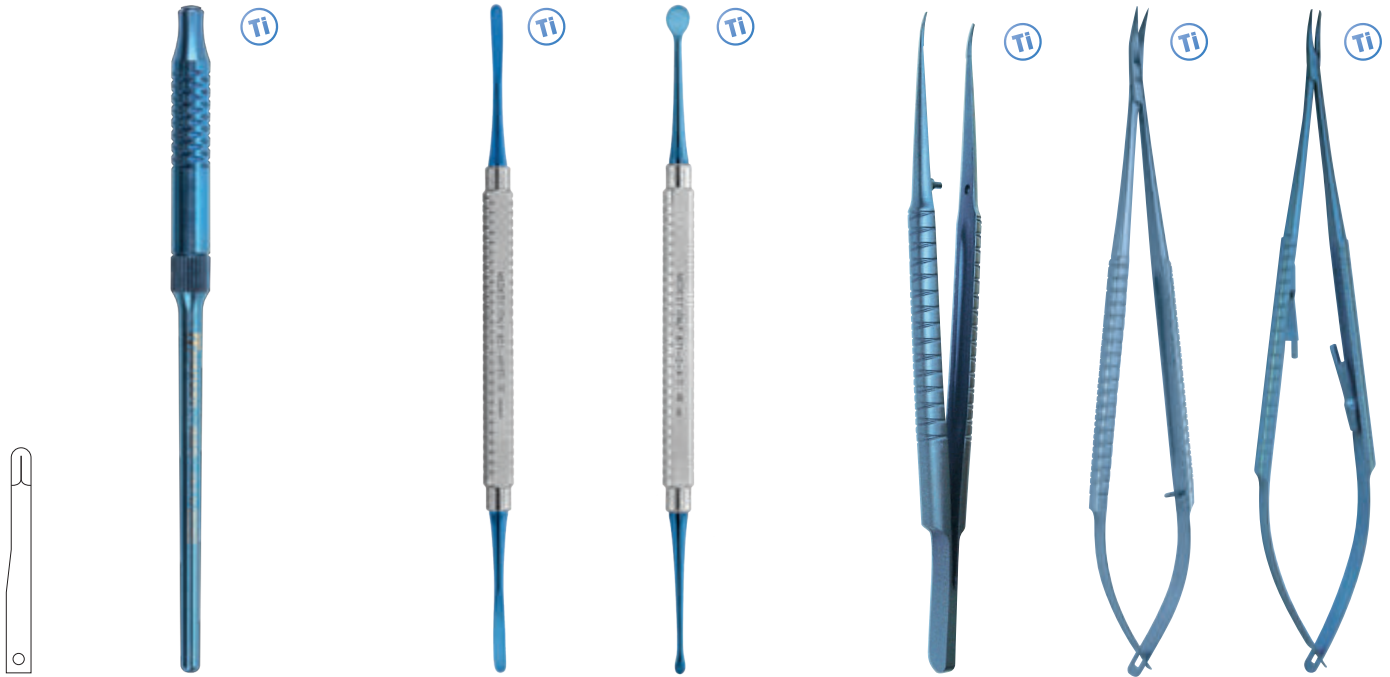

3638/69

Micro blade N. 69
Micro lama N. 69

3638/Ti (mm 135)

Handle for micro blades
Manico per microchirurgia

Titanium / Titanio

851/HP3 Ti

Periosteal HP3

Titanium / Titanio

871/2-4 Ti

Periosteal Molt

Titanium / Titanio

1141 (mm 150)

Micro tweezer
Micro pinzetta

Titanium / Titanio

1971 (mm 180)

Micro scissors
Micro forbici

Titanium / Titanio

2012 (mm 180)

Micro needleholder
Micro porta aghi

Titanium / Titanio

1671/7

Micro periodontal surgery kit
Kit per microchirurgia parodontale

Content / Contenuto:

1141	Micro tweezer Titanium curved
1971	Micro scissor Titanium curved
2012	Micro needle holder Titanium curved
3638/Ti	Handle for micro blades Titanium
3638/69	Micro blades N. 69, package 25 pcs (not shown)
851/HP3 Ti	Periosteal HP3 Titanium
871/2-4 Ti	Periosteal Molt Titanium
980/10	Gammatrix tray Tre

Content can be changed upon request
Su richiesta il contenuto può essere cambiato

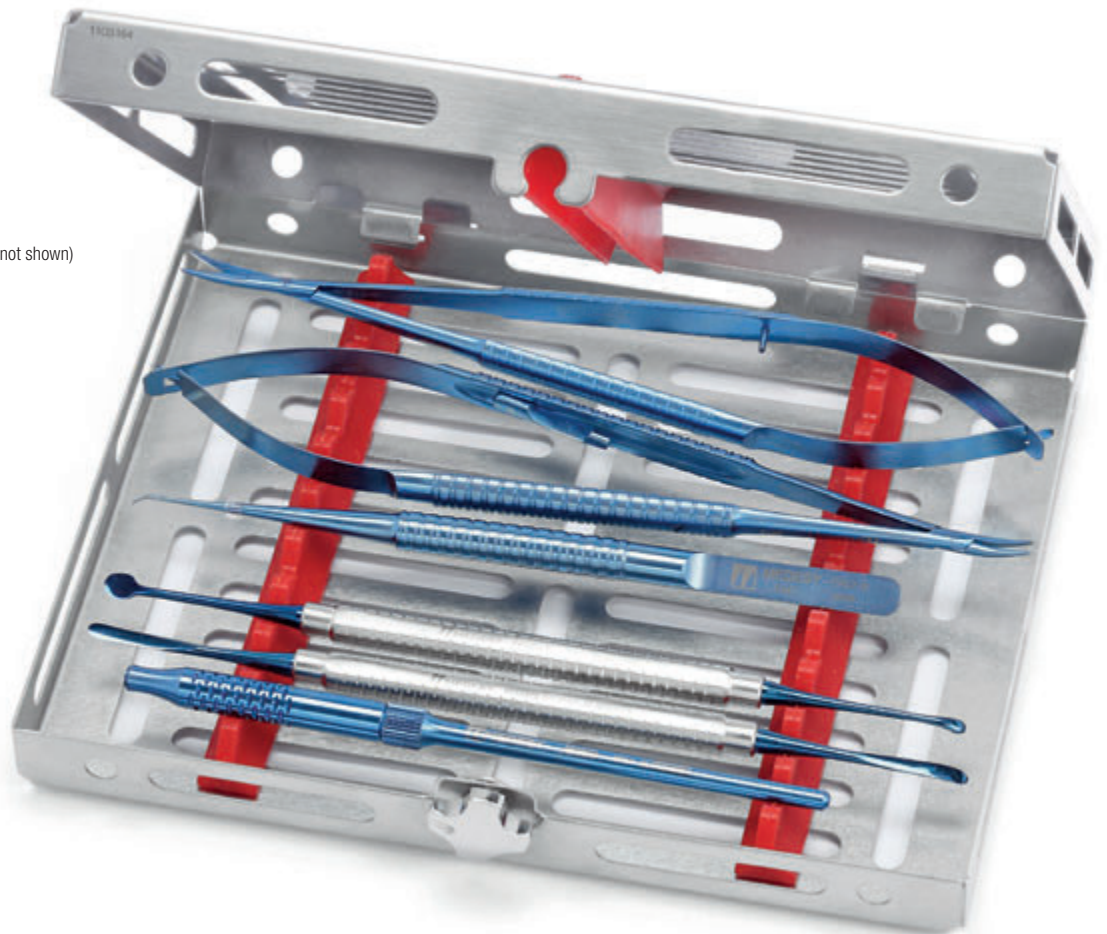



RESTORATIVE / CONSERVATIVA

∠ 2,1 mm



492/1

Goldstein N.1

Spatula / Plugger
Spatola / Otturatore

∠ 2,5 mm



492/2

Goldstein N.2

Spatula / Plugger
Spatola / Otturatore

∠ 2,5 mm



492/3

Goldstein N.3

Spatula / Spatula (thin)
Spatola / Spatola (sottile)

∠ 2,4 mm



492/4

Goldstein N.4

Spatula / Spatula (thin)
Spatola / Spatola (sottile)



∅ 1,5 mm



∅ 1,9 mm



∠ 2,5 mm



∠ 2,4 mm

∠ 1,6 mm



492/11

Goldstein N.11

Mini spatula / Plugger
Mini spatola / Otturatore

∠ 1,3 mm



492/14

Goldstein N.14

Mini spatula / Spatula
Mini spatola / Spatola



∅ 0,9 mm



∠ 1,3 mm

Goldstein, our new line of composite instruments: 4 different spatulas, one end spatula and one end plugger and extra thin flexible blades.

Nuova linea di strumenti per composito Goldstein: disponibili in 4 differenti spatole, spatole ed otturati e variante mini extra sottile.

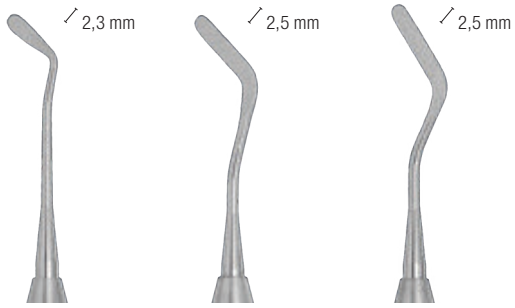

507/179
SS179

507/11
SS111

507/6
SS6

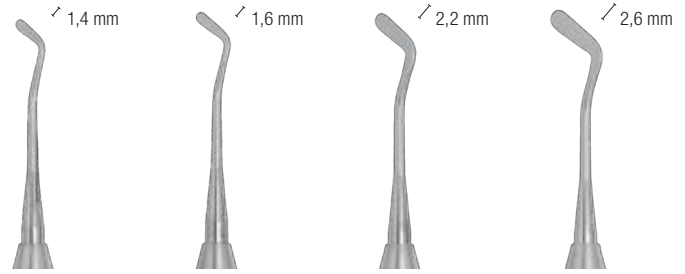

509/10
SS10

509/11
SS11

509/12
SS12

509/13
SS13

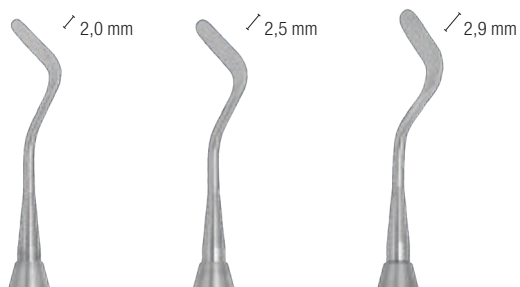
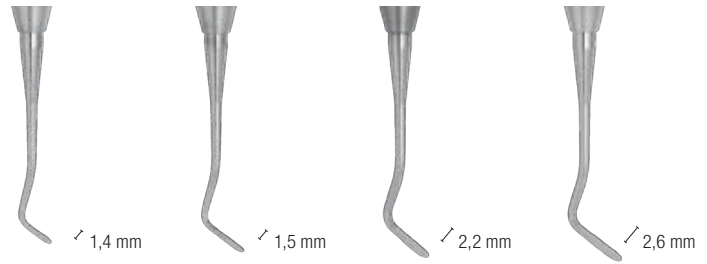

518/1
SS1

518/2
SS2

518/3
SS3

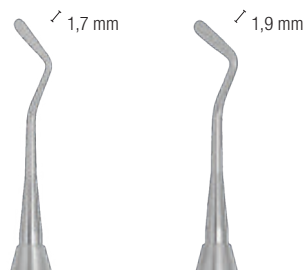

490/PF1A
PF1A

Spatula / Plugger
Spatola / Otturatore

491/PF1
PF1

Spatula / Plugger
Spatola / Otturatore

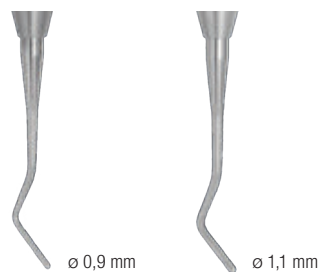
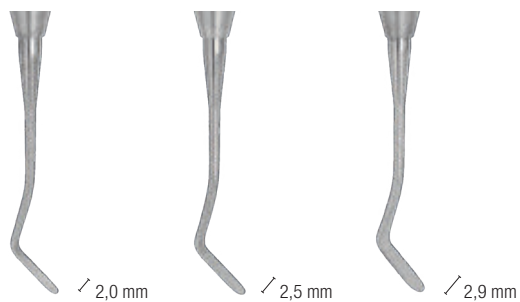

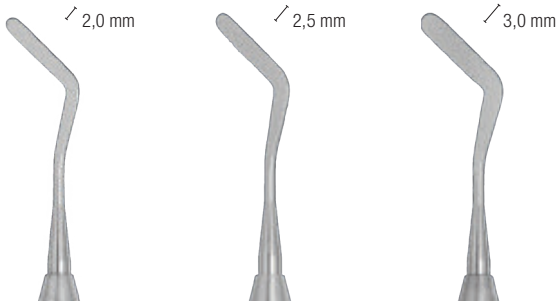

579/1

Heidemann N. 1

579/2

Heidemann N. 2

579/3

Heidemann N. 3

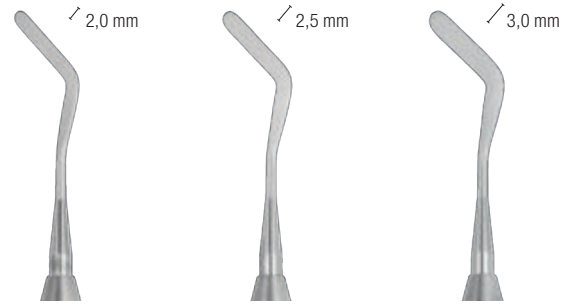

578/1

Heidemann N. 1

Flexible
Flessibile

578/2

Heidemann N. 2

Flexible
Flessibile

578/3

Heidemann N. 3

Flexible
Flessibile



580/1

Heidemann N. 1

Sharped
Affilata

580/2

Heidemann N. 2

Sharped
Affilata

580/3

Heidemann N. 3

Sharped
Affilata



579/1

Standard
Tradizionale

578/1

Flexible
Flessibile

580/1

Sharped
Affilata





494/1
BS1

494/2
BS2

494/3
BS3



497/1
BS4

497/2
BS5

497/3
BS6

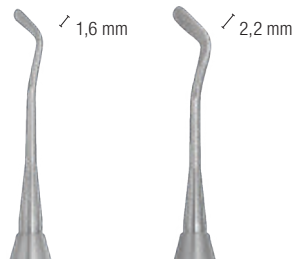

485/1
BP3

485/2
BP4

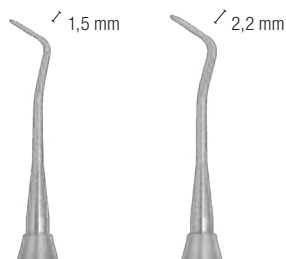

484/1
BP1

484/2
BP2



473/1
Woodson N. 1

473/2
Woodson N. 2

473/3
Woodson N. 3



COMPOSITE INSTRUMENTS TIN COATED

STRUMENTI PER COMPOSITO RICOPERTI TIN

New line of Composite Instruments
TiN coated (Titanium Nitride): the special
coating reduces composite or resin
stickiness, thus facilitating placement
modelling, sculpting and contouring steps.

Nuova linea di strumenti per composito
rivestiti con TiN (Nitrato di Titanio):
tale rivestimento riduce l'attaccamento
del materiale composito allo strumento stesso,
rendendone più facile la modellazione.

(1:1 scale / scala 1:1)

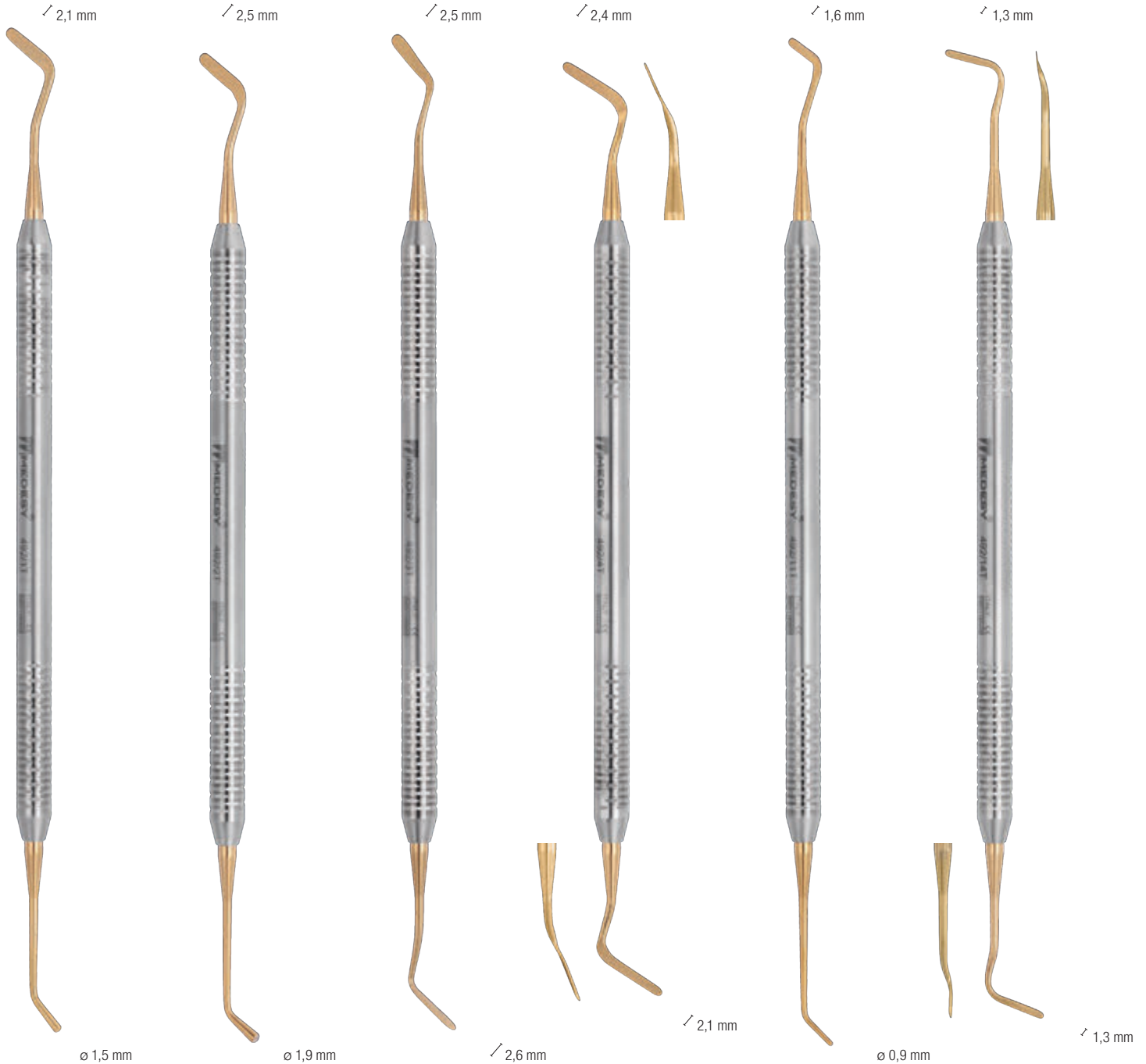

492/1T

Goldstein N. 1

Spatula / Plugger
Spatola / Otturatore

492/2T

Goldstein N. 2

Spatula / Plugger
Spatola / Otturatore

492/3T

Goldstein N. 3

Spatula / Spatula
Spatola / Spatola

492/4T

Goldstein N. 4

Spatula / Spatula
Spatola / Spatola

492/11T

Goldstein N. 11

Mini spatula / Plugger
Mini spatola / Otturatore

492/14T

Goldstein N. 14

Mini spatula / Spatula
Mini spatola / Spatola



499/1T



499/20T

Duck head
Testa d'anatra



521/1T
Westcott N. 21



499/9T

Elephant foot
Piede d'elefante



490/PF1AT
PF1A
Spatula / Plugger
Spatola / Otturatore



491/PF1T
PF1
Spatula / Plugger
Spatola / Otturatore



2,5 mm



2,5 mm



2,4 mm



2,5 mm



0,9 mm



1,1 mm



499/KIT

Content / Contenuto:

- 494/2T
- 499/1T
- 499/20T
- 500/2T
- 507/179T

Content can be changed upon request
Su richiesta il contenuto può essere cambiato





507/179T
SS179

507/11T
SS111

507/6T
SS6



509/10T
SS10

509/11T
SS11

509/12T
SS12

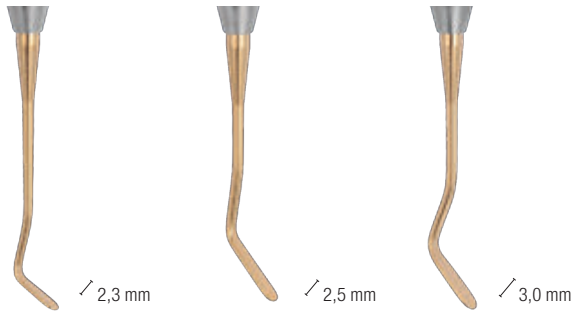

494/1T
BS1

494/2T
BS2

494/3T
BS3



497/1T
BS4

497/2T
BS5

497/3T
BS6

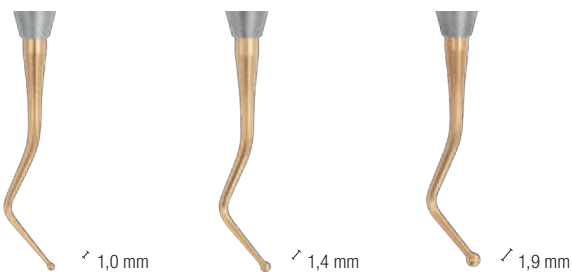

500/2T
(1:1 scale / scala 1:1)



500/1T
OT1



500/2T
OT2



500/3T
OT3



475/18T
Ball N.18



475/28T
Ball N.26/27S



1,2 mm



1,8 mm



2,2 mm



2,4 mm



2,0 mm

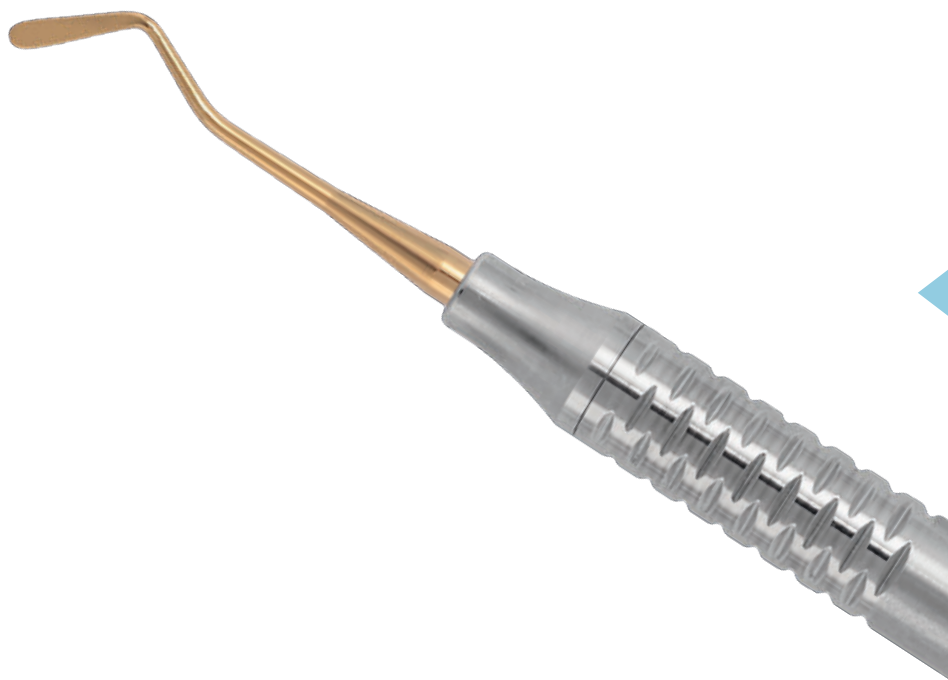

“ MEDESY IN SPOT

***Our Composite instruments
TiN coated, are now available also
with the brand new ergonomic
Dalila 8 mm handle,
try and feel the best comfort
also in restorative phase!***

*Strumenti per composito ricoperti
TiN, sono ora disponibili anche
nel nuovo ergonomico manico
Dalila 8 mm, maggiore comfort
anche in conservativa!*

”



RESTORATIVE / CONSERVATIVA



1675/3

Composite posterior kit
Kit per composito posteriore

Content / Contenuto:

479/29	Burnisher White
490/PF1AT	Composite instr. PF1A Titanium
499/1T	Composite instr. Titanium
499/9T	Composite instr. Titanium
500/1T	Composite instr. OT1 Titanium
521/1T	Burnisher Westcott N.21 Titanium
575/1	Ceramic instrument
575/3	Ceramic instrument
581/1	Modelling instr. PK Thomas
980/9	Gammaxif tray Doi



1675/4

Composite anterior kit
Kit per composito anteriore

Content / Contenuto:

490/PF1AT	Composite instr. PF1A Titanium
494/1T	Composite instr. BS1 Titanium
499/20T	Composite instr. Duck head Titanium
507/179T	Composite instr. SS179 Titanium
521/1T	Burnisher Westcott N.21 Titanium
575/1	Ceramic instrument
575/3	Ceramic instrument
581/1	Modelling instr. PK Thomas
980/9	Gammaxif tray Doi

1675/5

Composite advanced kit
Kit per composito avanzato

Content / Contenuto:

1024	Tweezer Meriam
3512	Scissor Iris curved
4583	Paper holder
475/29	Filling instr. N.29
490/PF1AT	Composite instr. PF1A Titanium
4905/8 + 4903/4	Mirror handle + Mirror #4
494/1T	Composite instr. BS1 Titanium
4958/1	Syringe Cook-Wait
499/1T	Composite instr. Titanium
499/20T	Composite instr. Duck head Titanium
499/9T	Composite instr. Titanium
500/1T	Composite instr. OT1 Titanium
507/179T	Composite instr. SS179 Titanium
521/1T	Burnisher Westcott N.21 Titanium
560/4	Explorer double N.6-3
575/1	Ceramic instrument
575/3	Ceramic instrument
581/1	Modelling instr. PK Thomas
981/20	Gammafix tray Cinc

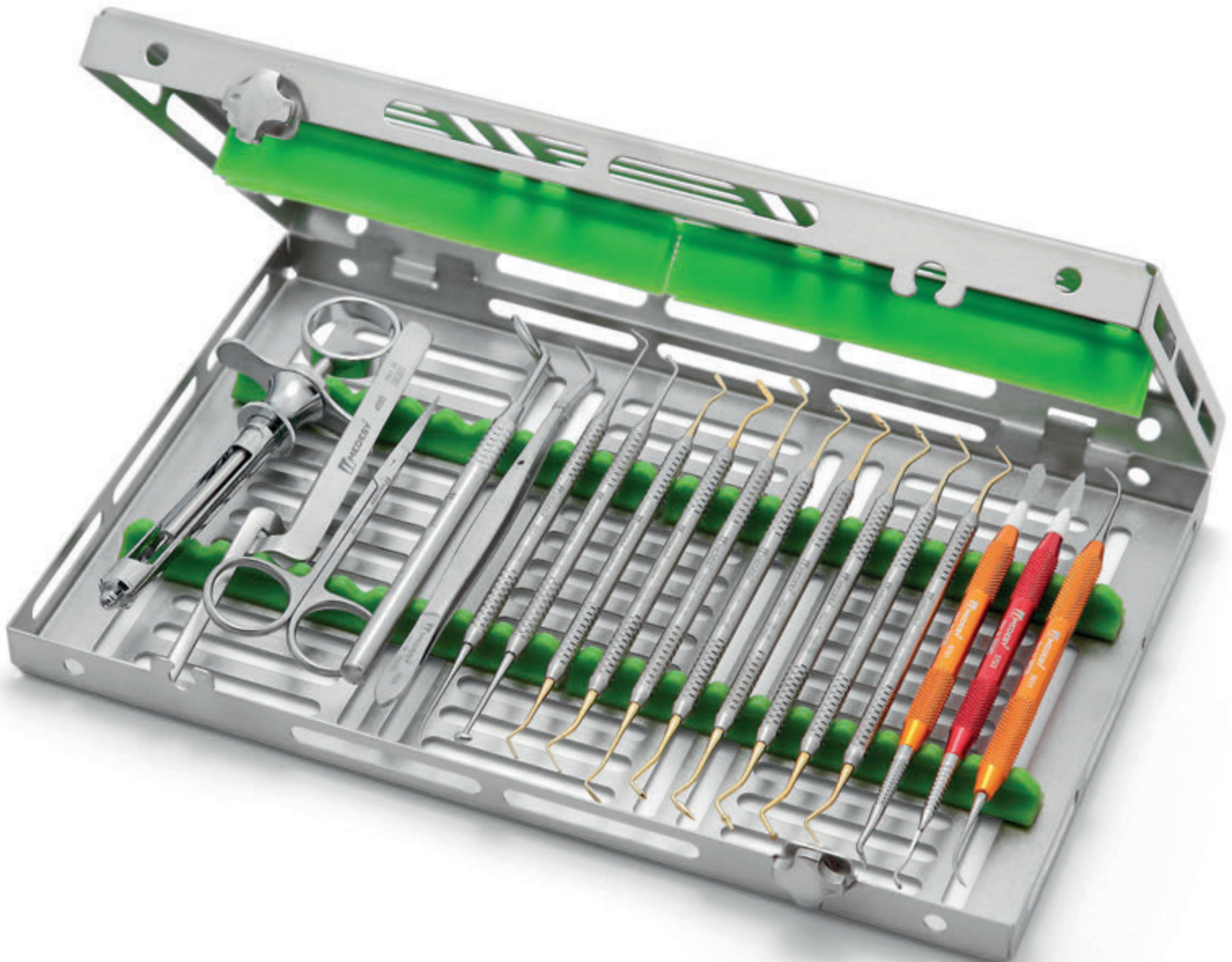

RESTORATIVE / CONSERVATIVA

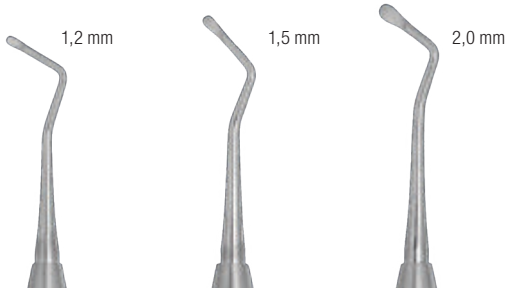

663/17
Oval spoon
17W

663/18
Oval spoon
18W

663/19
Oval spoon
19W

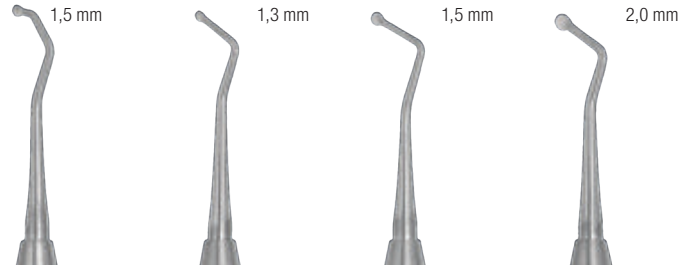

664/14
Spoon

664/17
Spoon

664/18
Spoon

664/19
Spoon



DENTIN'S REMOVAL



665/31
31L
Endodontic
excavators

665/32
32L
Endodontic
excavators

665/33
33L
Endodontic
excavators

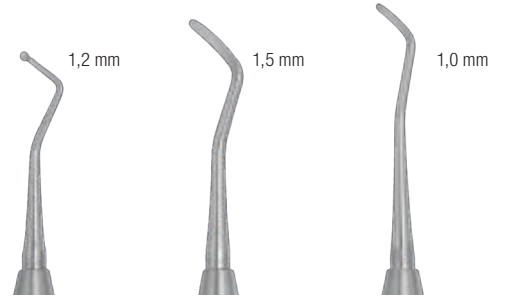

668/39
38/39
Spoon

668/64
63/64
Blade

668/66
65/66
Blade



670/1
(1:1 scale / scala 1:1)



670/0
670/0.HL8

670/1
670/1.HL8

670/2
670/2.HL8

670/3
670/3.HL8

670/4
670/4.HL8

671/1

671/2

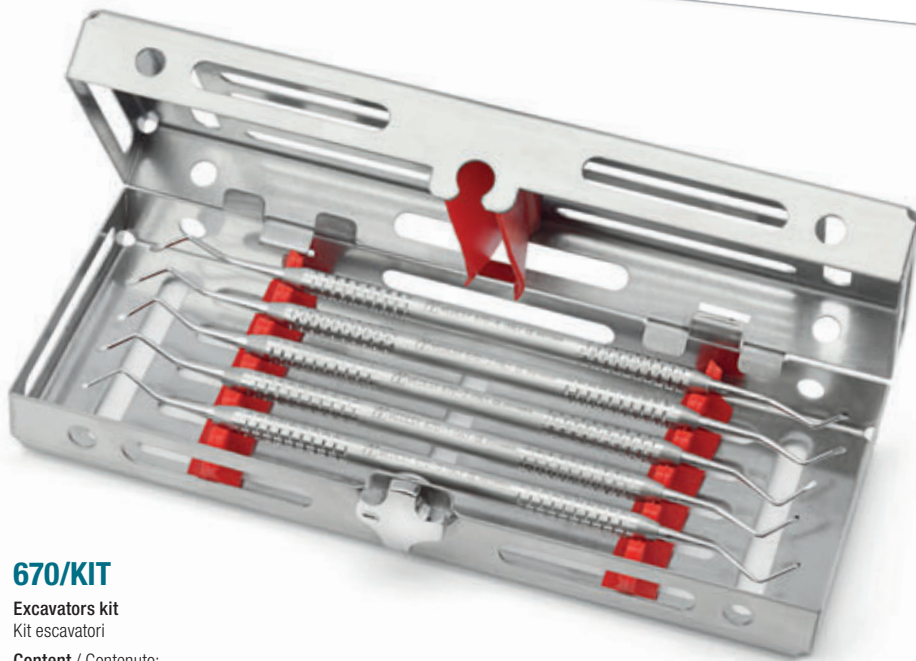

670/KIT

Excavators kit
Kit escavatori

Content / Contenuto:

- 670/0
- 670/1
- 670/2
- 670/3
- 670/4

On request available with 8 mm hollow handle,
ask for **670/KIT.HL8**
Su richiesta è disponibile con manico vuoto da 8 mm,
chiedi il **670/KIT.HL8**

“ MEDESYS IN SPOT

*Excavators included in the line 670, all sizes, are also available with blue titanium coated tip, just add **Ti** to the standard code to order the item in the titanium finish.*

*Escavatori della serie 670 sono disponibili in tutte le misure con la punta anodizzata al Titanio blu, aggiungere **Ti** dopo il codice.*

(Es. 670/1 > 670/1-Ti) ”

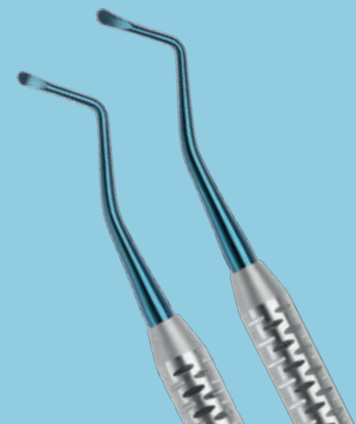

RESTORATIVE / CONSERVATIVA



2,5 mm



2,0 mm



1,8 mm



1,4 mm



1,0 mm



1,0 mm



1,5 mm

671/125-126

English shape
Forma inglese

671/127-128

English shape
Forma inglese

671/129-130

English shape
Forma inglese

671/131-132

English shape
Forma inglese

671/133-134

English shape
Forma inglese

671/153-154

English shape
Forma inglese

671/155-156

English shape
Forma inglese



1,2 mm



1,5 mm



2,5 mm

672/3
NYU E1

672/4
NYU E2

672/5
NYU E3



1,0 mm



1,4 mm



2,0 mm

611/243
243

611/244
244

611/245
245



ENAMEL INSTRUMENTS

STRUMENTI TAGLIA SMALTO-DENTINA



MARGIN TRIMMERS

HATCHES



612/26
Black 26
Distal
Distale

612/27
Black 27
Mesial
Mesiale

612/28
Black 28
Distal
Distale

612/29
Black 29
Mesial
Mesiale

613/78
Black 77/78
Distal
Distale

613/80
Black 79/80
Mesial
Mesiale

614/52
Black 51/52

614/54
Black 53/54

615/1
Black 1

615/2
Black 2

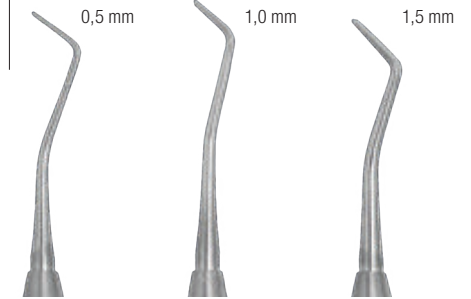
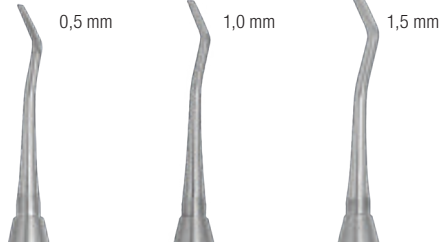

609/1

609/2

609/3

609/4

609/5

609/6

609/7

609/8

609/9



RESTORATIVE / CONSERVATIVA

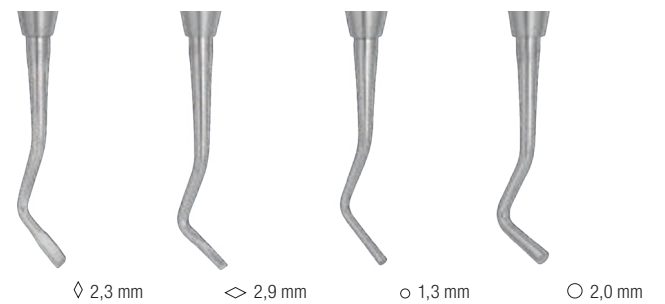
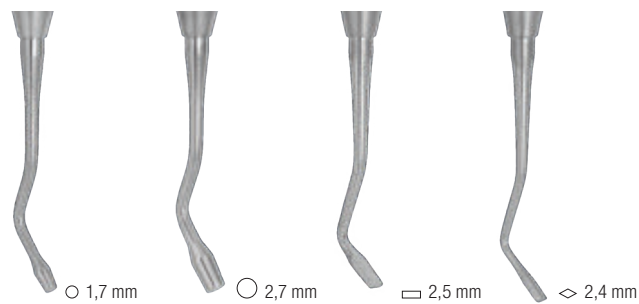
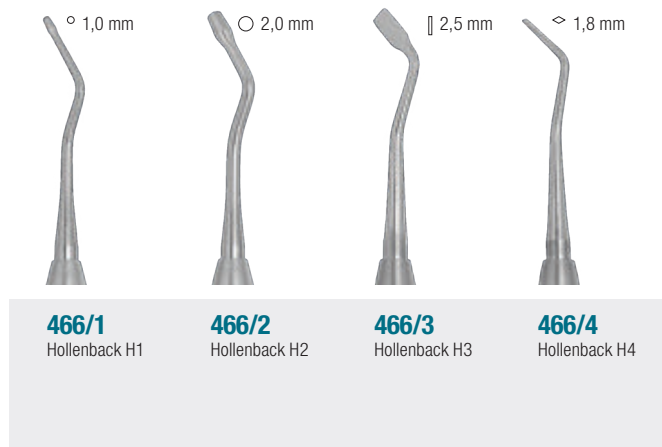
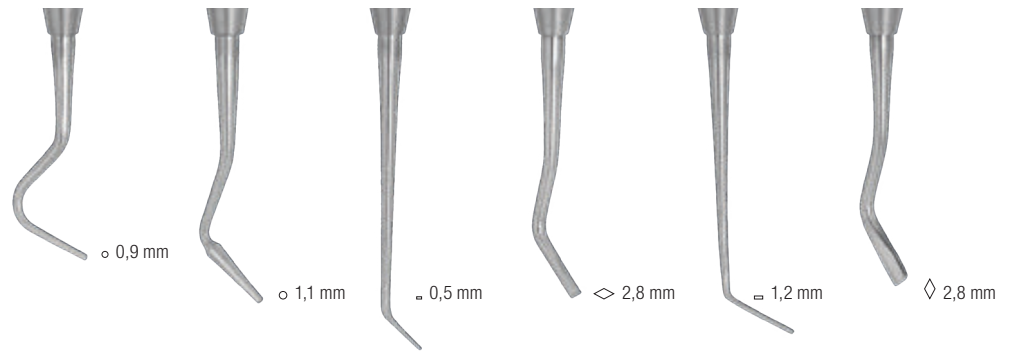
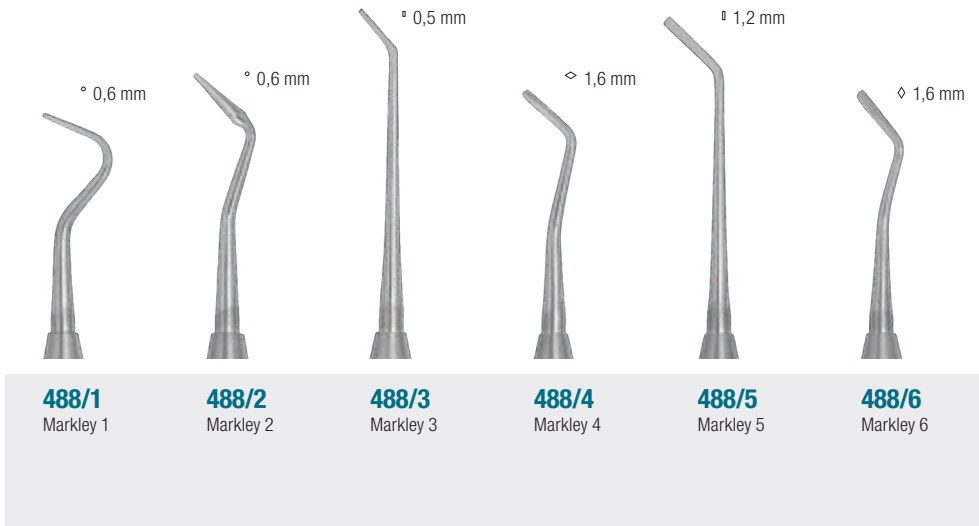

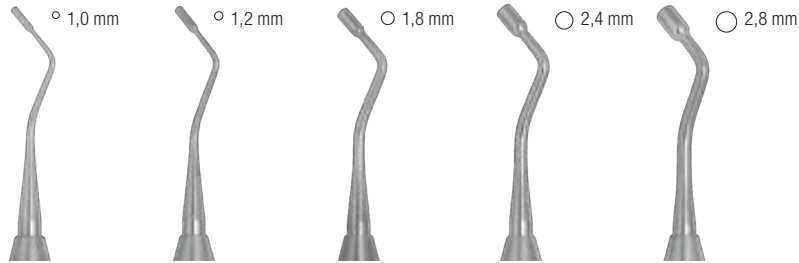

527/0
M0
Smooth
Lisci

527/1
M1
Smooth
Lisci

527/2
M2
Smooth
Lisci

527/3
M3
Smooth
Lisci

527/4
M4
Smooth
Lisci

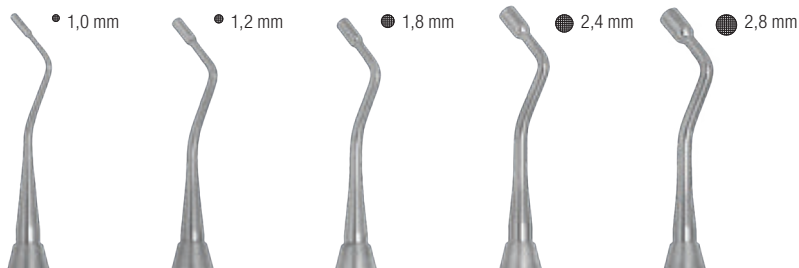
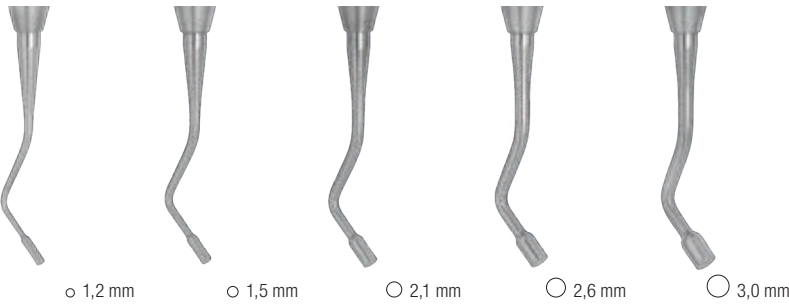

527/0Z
M0Z
Serrated
Zigrinati

527/1Z
M1Z
Serrated
Zigrinati

527/2Z
M2Z
Serrated
Zigrinati

527/3Z
M3Z
Serrated
Zigrinati

527/4Z
M4Z
Serrated
Zigrinati



“ MEDESY IN SPOT

Perfect knurling entirely obtained using complex and advanced CNC machines.

Zigrinatura perfetta eseguita interamente con macchine CNC. ”



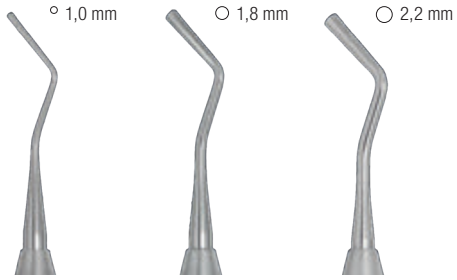

523/1
MT1
Smooth
Lisci

523/2
MT2
Smooth
Lisci

523/3
MT3
Smooth
Lisci

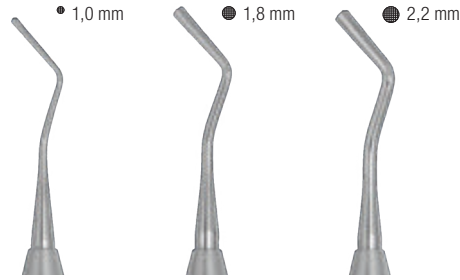

523/1Z
MT1Z
Serrated
Zigrinati

523/2Z
MT2Z
Serrated
Zigrinati

523/3Z
MT3Z
Serrated
Zigrinati

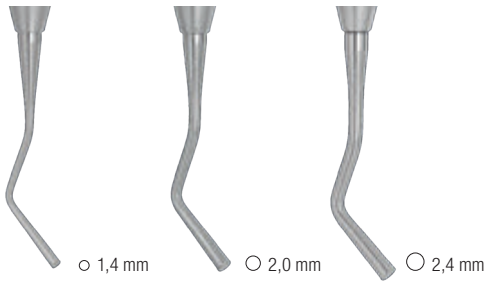

○ 1,4 mm

○ 2,0 mm

○ 2,4 mm

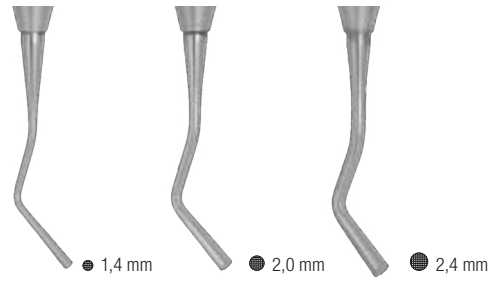

● 1,4 mm

● 2,0 mm

● 2,4 mm

**“ MEDESYS IN SPOT
530 VS 523 VS 523/Z ”**

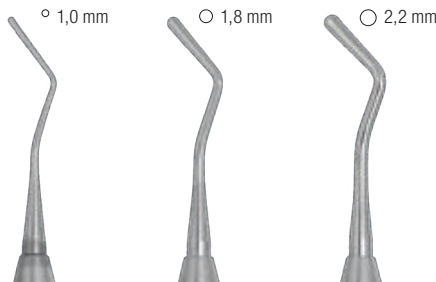
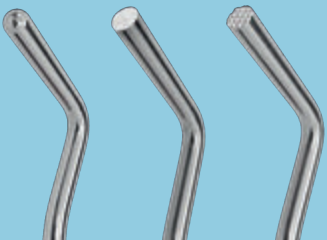

530/1
MT1R
Round
Arrotondata

530/2
MT2R
Round
Arrotondata

530/3
MT3R
Round
Arrotondata



474/2
Ladmore N. 2

474/3
Ladmore N. 3



○ 1,4 mm

○ 2,0 mm

○ 2,4 mm



○ 1,9 mm

○ 1,9 mm



500/0
OT0



500/1
OT1



500/2
OT2



500/3
OT3



500/4
OT4



500/5
OT5



502/1
Three angle



502/2
Three angle



582

584

587



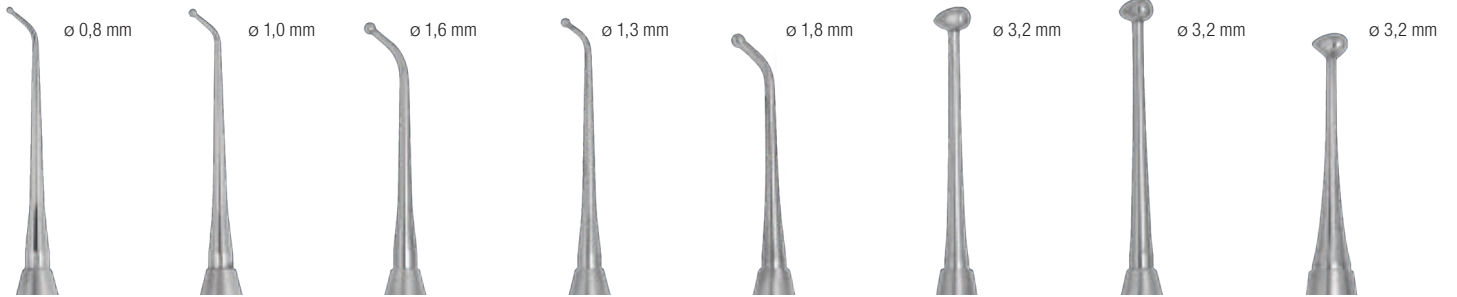

475/15
Ball 15

475/16
Ball 16

475/18
Ball 18

475/28
Ball 26/27S

475/29
Ball 27/29

475/30
Ball 28/29

472/2
Ball 29 / Spatula

479/29
Ball 29

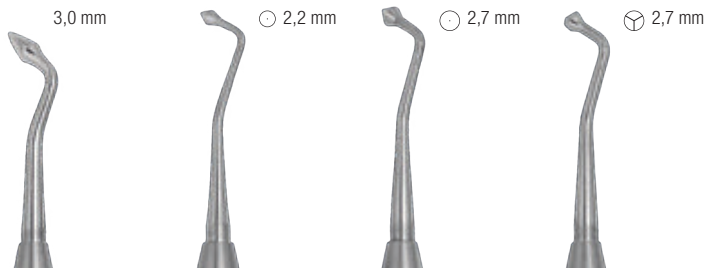

586/1
NYU/B2

521/1
Westcott N. 21

521/2
Westcott N. 21B

521/3
Romerowski



478
Bennet

477/32
White

477/33
White

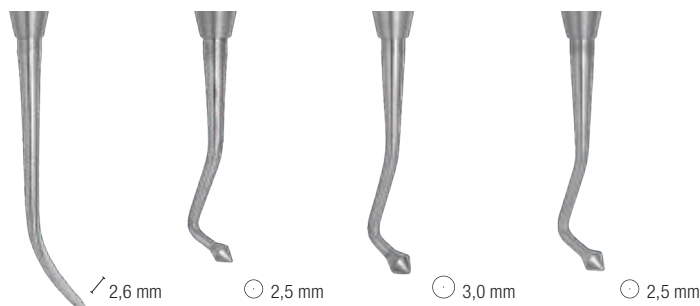

AMALGAM CARVERS

RIFINITORI PER AMALGAMA



600/1
Ward 1

600/2
Ward 1S

600/3
Ward 2



601/2
Hollenback 1/2

601/3
Hollenback 3

601/4
Hollenback 3S



604/1
Interproximal 1
IPC1

604/2
Interproximal
Off-Angle

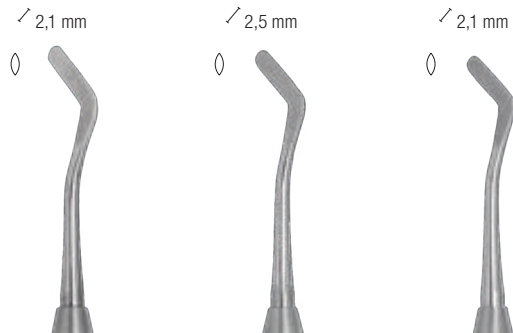

610/1
Nystrom 1

610/2
Nystrom 2

610/3
Nystrom 3

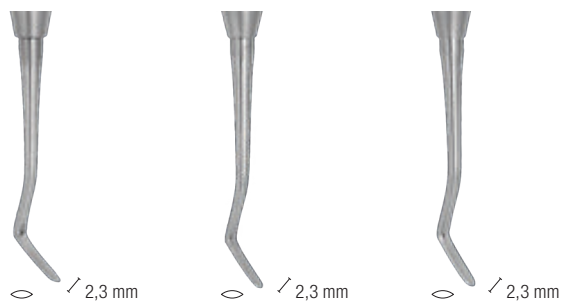
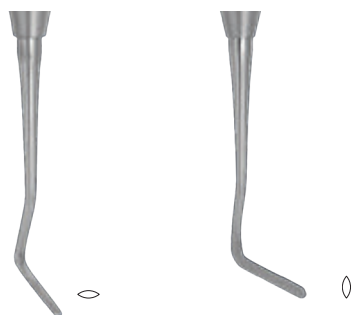

RESTORATIVE / CONSERVATIVA



605/1
Shoshan-A



605/3
Shoshan-3



605/8
Wiland 8



607
Sprengel 18



602/1
Frahm 0/1



602
Frahm 2/3



603
USC 2



605/4
104



616/2
Wedelstaedt 1/2
To refine cavity preparation



616/4
Wedelstaedt 3/4
To refine cavity preparation



616/6
Wedelstaedt 5/6
To refine cavity preparation



CHISELS

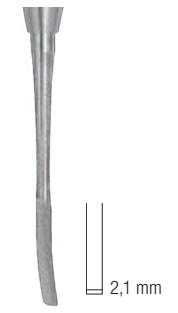



CLEIDS

Pointed for carving
occlusal section

Appuntito per rifinire
la sezione occlusale



DISCOIDS

For removing
the material in excess

Per rimuovere
il materiale in eccesso



(1:1 scale / scala 1:1)

○ 1,7 mm



○ 2,0 mm



○ 2,5 mm



2,1 mm



○ 3,0 mm



2,2 mm



608/0
N. 0

608/1
N. 89/92

608/2
N. 4/5

608/3
W-A-C-D

608/4
N. 3/6

608/5
N. 110



RESTORATIVE / CONSERVATIVA

1675/2

Amalgam basic kit
Kit per amalgama basic

Content / Contenuto:

466/1	Filling instr. Hollenback H1
466/2	Filling instr. Hollenback H2
479/29	Burnisher White
4855	Amalgam well
4864	Amalgam carrier
560/4	Explorer double 16/3
601/3	Amalgam carver Hollenback 3
980/9	Gammatrix tray Doi



1675/1

Amalgam advanced kit
Kit per amalgama advanced

Content / Contenuto:

1024	Tweezer Meriam
3512	Scissor Iris curved
4583	Paper holder
466/1	Filling instr. Hollenback H1
466/2	Filling instr. Hollenback H2
479/29	Burnisher White
4855	Amalgam well
4864	Amalgam carrier
4905/8	Handle with mirror n.4
4958/1	Syringe Cook-Wait
4975	Matrix retainer Tofflemire
4979/12	Matrix band Tofflemire
560/3	Explorer double
600/1	Amalgam carver Ward 1
601/2	Amalgam carver Hollenback 1/2
601/3	Amalgam carver Hollenback 3
612/28	Enamel instr. Black 28
612/29	Enamel instr. Black 29
981/20	Gammatrix tray Cinc

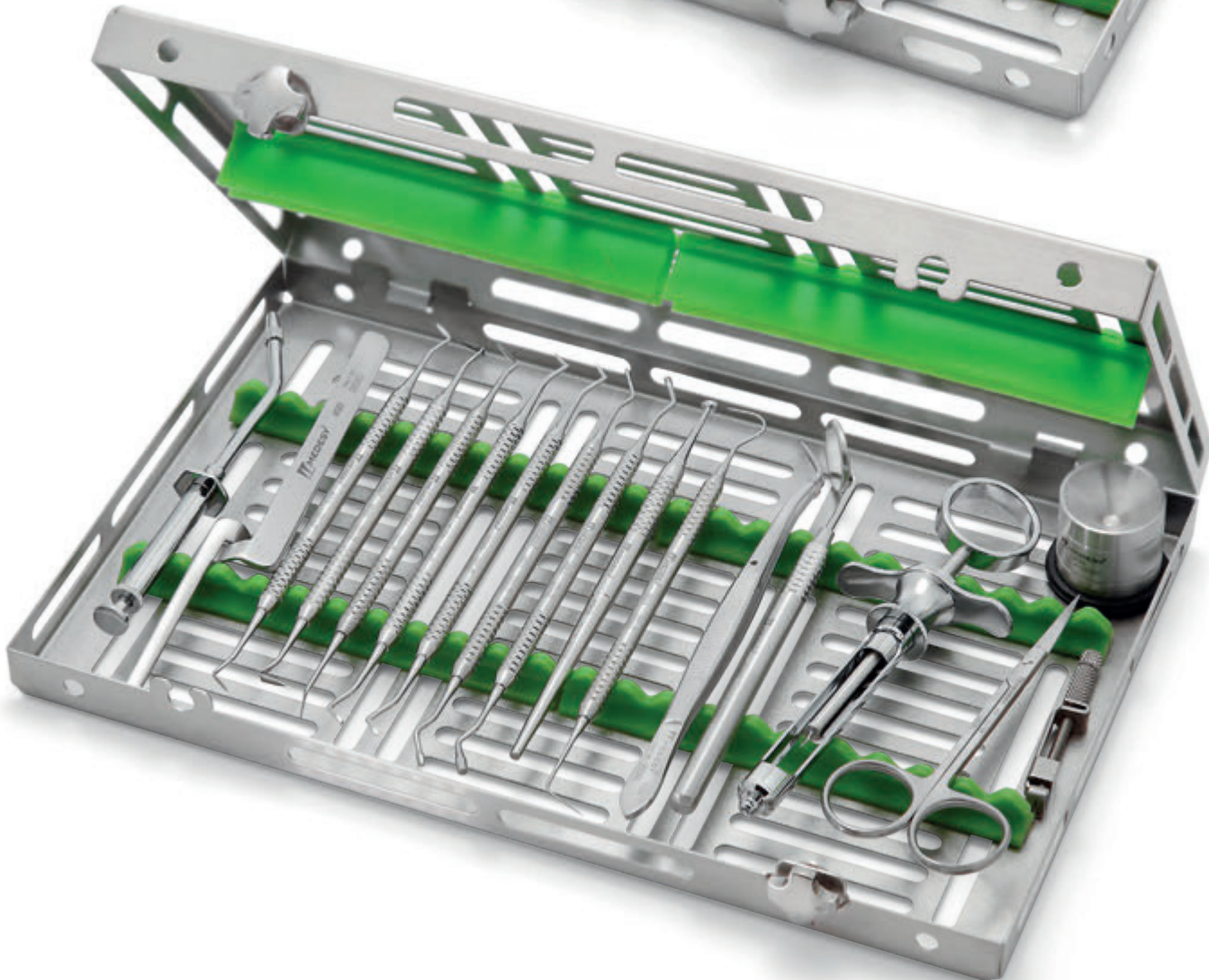

GINGIVAL CORD PACKER

STRUMENTI PER FILO RETRATTORE



WITH SERRATION / CON RITENZIONE



585

Squared
Quadro

585/81

Universal
Universale

585/MSY

Round
Tondo



WITHOUT SERRATION / SENZA RITENZIONE



585/4-L
CSI-1

585/81-L

Universal
Universale

585/MSY-L

Round
Tondo



RESTORATIVE / CONSERVATIVA

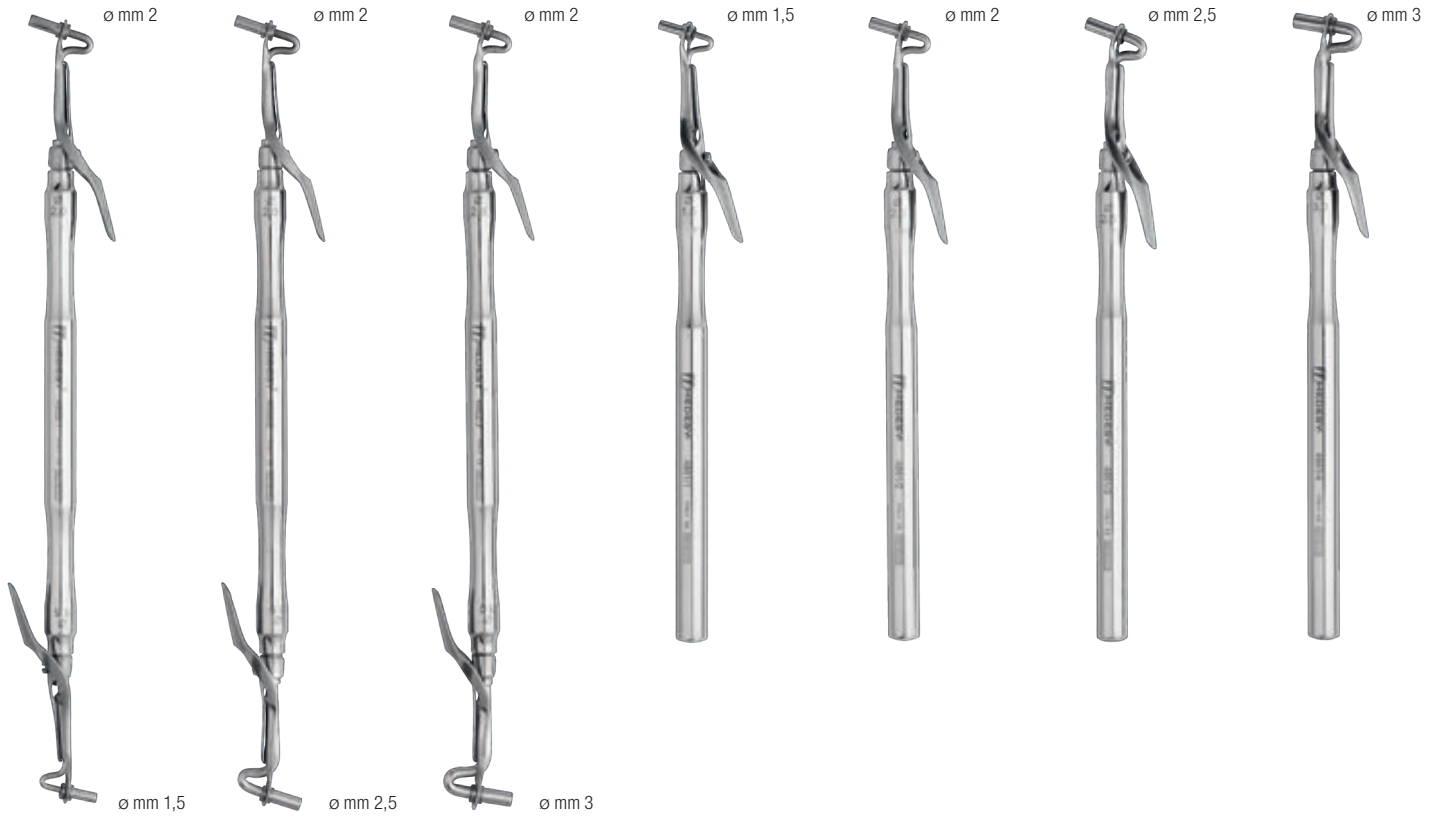

4862/1 (mm 195)
Medium/Small
Medio/Piccolo

4862/2 (mm 195)
Medium/Large
Medio/Grande

4862/3 (mm 195)
Medium/Jumbo
Medio/Enorme

4861/1 (mm 155)
Small
Piccolo

4861/2 (mm 155)
Medium
Medio

4861/3 (mm 155)
Large
Grande

4861/4 (mm 155)
Jumbo
Enorme

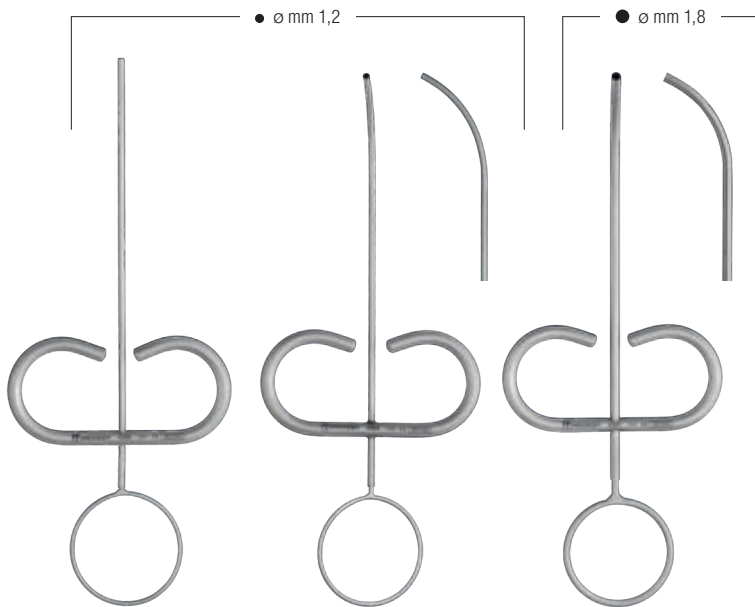

4865 (mm 135)
Straight
Retta

4866 (mm 130)
Curved
Curva

4880 (mm 130)
Curved
Curva



4867 (mm 135)

4859 (mm 150)
Jumbo

PLASTIC AUTOCLAVABLE
PLASTICA STERILIZZABILE IN AUTOCLAVE

ø mm 2,5

4856/1
Spare part
Puntale ricambio

4857/2
Spare part
Puntale ricambio

ø mm 2,5

4858/3
Spare part
Puntale ricambio

4856 (mm 170)
Curved 15°
Curvo 15°

4857 (mm 165)
Curved 45°
Curvo 45°

4858 (mm 155)
Curved 90°
Curvo 90°

4864 (mm 145)
Curved 15°
Curvo 15°

4869 (mm 140)
Curved 45°
Curvo 45°

4863 (mm 125)
Curved 90°
Curvo 90°

ø 30 mm

ø 30 mm

h 30 mm

h 25 mm

4855
Amalgam well in stainless steel
Mortajo per amalgama in acciaio

4854
Amalgam well in stainless steel
Mortajo per amalgama in acciaio

6300
mm 150 × 80 × 15
Mixing glass
Piastra vetro per impasti

216/A (Orange / Arancione)
216/B (Blue / Blu)
216/V (Green / Verde)

Dappen dish made
in silicone autoclavable
Porta amalgama
in silicone autoclavabile





4930
(mm 5-6-7)
Universal

Matrix retainer with cheek protector
Portamatrice con protezione delle guance



4973
(mm 5-6-7)
Ivory 8 N

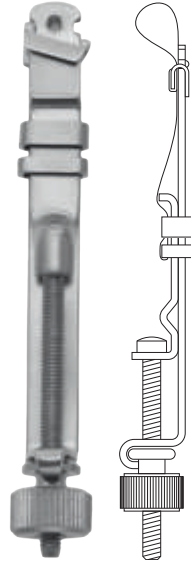

4972/NS
(mm 5-6-7)
Siqueland

Narrow
Stretto



4972/WL
(mm 5-6-7)
Siqueland

Wide
Largo



4970
(mm 6)
Nystrom

Left
Sinistro



4971
(mm 6)
Nystrom

Right
Destro



4977
(mm 5-6)
Didner 8 P



4975
(mm 5-6-7)
Tofflemire
Universal



4976
(mm 5)
Tofflemire-Junior



4978
Ivory N 12

(1:1 scale / scala 1:1)

FOR PREMOLARS / PER PREMOLARI



4979/4 (Ivory) Fig. 11



4979/5 (Ivory) Fig. 12



4979/6 (Ivory) Fig. 13

FOR MOLARS / PER MOLARI



4979/1 (Ivory) Fig. 14



4979/2 (Ivory) Fig. 15



4979/3 (Ivory) Fig. 16

Thick 0,04 mm / Spessore 0,04 mm
Package 12 pcs / Confezioni 12 pz

FOR MOLARS AND PREMOLARS / PER MOLARI E PREMOLARI



4979/7 (Nystrom)



4979/9 (Nystrom)



4979/11 (Tofflemire)



4979/8 (Nystrom)



4979/10 (Nystrom)



4979/12 (Tofflemire)



4979/13 (Tofflemire)

Thick 0,04 mm / Spessore 0,04 mm
Roll of 1 m / Rotolo da 1 m



4974/5 (mm 5 × 100 cm)

4974/6 (mm 6 × 100 cm)

4974/7 (mm 7 × 100 cm)



The **DENTAL DAM**, invented more than a century ago by Dr. Barnum, is used in dentistry to reduce contamination due to the need for the area to remain dry and isolated.

The main function of the rubber dam is to isolate the tooth being treated from its environment, in particular from the bacteria of the oral cavity: this permits a clean and dry operative field from saliva or blood.

Another function of the rubber dam is to protect the patient's airway from any materials which may fall into it during treatment. The dental dam improve the visibility of the tooth under treatment, reducing any risk for cheek and tongue.

For adhesive dentistry procedures involving bonding dental composite it is to be encouraged as the operative field must avoid moisture contamination in order to get the maximum bond strength from restorative material to tooth substance.

The dental dam is today considered a fundamental advantage for the dentist and for the patient to the point that a dental treatment is not considered fully correct if performed without the device.

MEDESYS dental dams contain little latex protein and are powder-free to minimize the risk of skin allergies to sensitive patients.

La **DIGA DENTALE**, inventata oltre cento anni fa dal Dr. Barnum, è utilizzata in odontoiatria per ridurre il rischio di contaminazione e mantenere l'area in cui si sta operando in condizioni asciutte ed isolate.

La funzione principale della diga dentale è quella di isolare il dente da trattare dal suo ambiente, in particolare dai batteri del cavo orale: ciò consente un campo operatorio pulito ed asciutto senza contaminazione da sangue o saliva.

Un'altra funzione della diga dentale è di proteggere le vie aeree del paziente da tutti i materiali che possono essere ingeriti durante il trattamento. La diga migliora la visibilità del dente da trattare, spostando guance e lingua riducendone il rischio di tagliarle.

Per gli interventi di odontoiatria che coinvolgono l'utilizzo del composito dentale è da incoraggiare l'utilizzo della diga per evitare che il campo operatorio sia contaminato dall'umidità ed al fine di ottenere la massima resistenza e performance dal materiale di restauro.

La diga dentale è oggi considerata un vantaggio fondamentale per il dentista e per il paziente al punto che un trattamento dentale non viene considerato pienamente corretto se eseguito senza questo dispositivo.

Le dighe in lattice MEDESYS sono specificamente trattate per ridurre il contenuto della proteina del lattice e quindi minimizzare il rischio di allergie cutanee. Inoltre non contengono alcuna traccia di polvere per impedire che i fogli di diga si attacchino gli uni agli altri, la quale provocherebbe reazioni allergiche a pazienti sensibili.

5610/M-B

Rubber dam blue-plain
Diga dentale blu-neutra



5610/M-V

Rubber dam green-mint
Diga dentale verde-menta

ANTERIORES
ANTERIORI



5595/0

Small jaws and high bow for anteriors

Tooth / Dente:
6-7-8-9-10-11-22-23-24-25-26-27



5595/9

Most popular anterior clamp, with flat jaws

Tooth / Dente:
6-7-8-9-10-11-22-23-24-25-26-27



5595/00

Small jaws and high bow for anteriors and small premolars

Tooth / Dente:
6-7-8-9-10-11-22-23-24-25-26-27



5595/210

One small and one large jaw, for anteriors

Tooth / Dente:
6-7-8-9-10-11-22-23-24-25-26-27



5595/212

Flat jaws for labials cavities on anteriors

Tooth / Dente:
6-7-8-9-10-11-22-23-24-25-26-27

UPPER JAW / ARCATA SUPERIORE

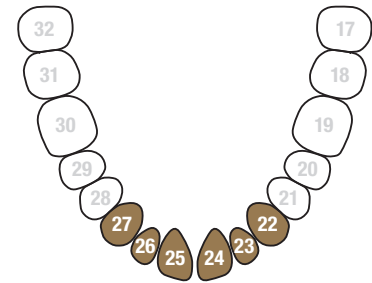
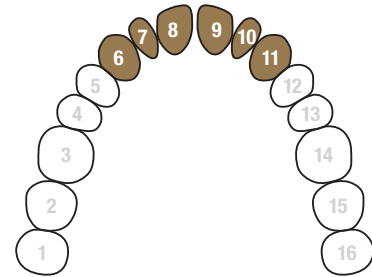

LOWER JAW / ARCATA INFERIORE



Dr. Giuliano Corrozzatto, after completing the college studies and training as a dental technician he earned a degree in dentistry at the university of Trieste with a doctoral thesis on digital radiology applied for use in the dentistry procedures. A healthcare professional with a long track record of successfully diagnosing and treating patients' dental conditions gathered in many years of cooperation with several clinics and dental teams. He now practises and manages his own dental centre providing a full range of dental treatment to patients to help them maintain oral health. He has been regularly cooperating on many projects with MEDESYS Research and Development Department mainly in the field of conservative dentistry spending a significant amount of time evaluating and testing specialist innovative equipment. To review Dr. Corrozzatto's videos on the use and the placement of the dental dam click on www.medesy.it

Dr. Giuliano Corrozzatto, dopo aver conseguito il diploma di odontotecnico, si laurea in odontoiatria all'università di Trieste con tesi di laurea in radiologia digitale applicata all'odontoiatria. Dopo molteplici collaborazioni e ottimi risultati conseguiti nell'ambito odontoiatrico, diventa titolare di un proprio studio dentistico. Da diversi anni collabora con MEDESYS, sviluppando assieme al dipartimento di ricerca e sviluppo nuovi strumenti nel settore della odontoiatria conservativa. Per visionare i video sul montaggio della diga dentale del Dr. Corrozzatto, connettersi su www.medesy.it



RESTORATIVE / CONSERVATIVA



5595/1

General purpose
for upper premolars

Tooth / Dente:
4-5-12-13



5595/1A

Deeply festooned jaws
grasps premolar's roots

Tooth / Dente:
4-5-6-11-12-13-20-21-22-27-28-29



5595/2A

Flat and large jaws
for lower premolars

Tooth / Dente:
20-21-28-29



5595/27

Rounded jaws for premolars

Tooth / Dente:
4-5-12-13-20-21-28-29



5595/29

Rounded and flat jaws
for premolars

Tooth / Dente:
4-5-12-13-20-21-28-29



5595/206

Festooned jaws for premolars

Tooth / Dente:
4-5-12-13-20-21-28-29



5595/208

Festooned and flat jaws
for large premolars

Tooth / Dente:
4-5-12-13-20-21-28-29



UPPER JAW / ARCATA SUPERIORE

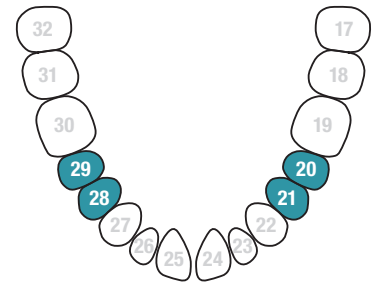
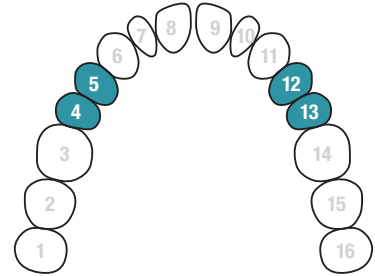

LOWER JAW / ARCATA INFERIORE

New clamps for MEDESYS dental dam, superior quality in all details.

The superior quality of the stainless steel and a special temper treatment preserve the elasticity of the new MEDESYS clamps and ensure a longer endurance to stress.

The anchorage holes are compatible with any type of clamp forceps; the edges are bevelled to offer more comfort during utilisation.

Also the new rubber dam clamps, as all the other MEDESYS instruments, have a life time warranty against manufacture or material defects.

Nuovi uncini per diga MEDESYS, alta qualità in ogni dettaglio.

Grazie all'acciaio di prima scelta ed un trattamento termico speciale, i nuovi uncini per diga MEDESYS mantengono inalterata la loro elasticità per molto tempo.

I fori di ancoraggio sono universalmente compatibili con le varie forme di pinze per uncini, mentre i bordi sono smussati per un maggior comfort.

Come tutti gli strumenti MEDESYS, i nuovi uncini per diga sono garantiti contro ogni eventuale difetto di materiale o lavorazione per tutta la durata della loro vita.



MOLARS (GENERAL)

MOLARI (GENERALE)



UPPER JAW / ARCATA SUPERIORE

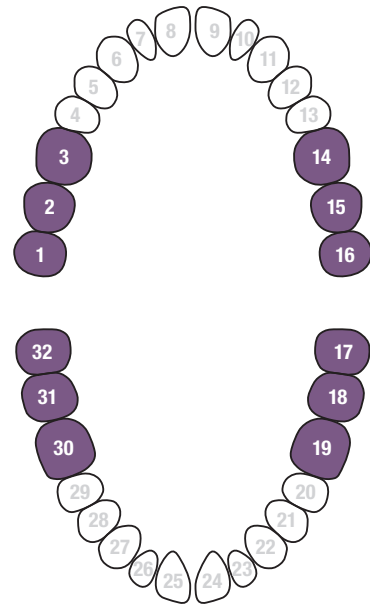

LOWER JAW / ARCATA INFERIORE



5595/8A

Deeply festooned jaws grasps root at corners

Tooth / Dente:

1-2-3-14-15-16-17-18-19-30-31-32



5595/10

Flat jaws for uppers left and lowers right molars

Tooth / Dente:

14-15-16-30-31-32



5595/11

Flat jaws for uppers right and lowers left molars

Tooth / Dente:

1-2-3-17-18-19



5595/14

Festooned jaws for half erupted and undersized molars

Tooth / Dente:

1-2-3-14-15-16-17-18-19-30-31-32



5595/14A

As 14, but larger

Tooth / Dente:

1-2-3-14-15-16-17-18-19-30-31-32



5595/18

Flat jaws with round shape, for molars

Tooth / Dente:

1-2-3-14-15-16-17-18-19-30-31-32



5595/28

Flat jaws for molars, general purposes

Tooth / Dente:

1-2-3-14-15-16-17-18-19-30-31-32



5595/51

Flat triple jaws for molars

Tooth / Dente:

1-2-3-14-15-16-17-18-19-30-31-32



5595/W8A

Festooned jaws for molars' roots

Tooth / Dente:

1-2-3-14-15-16-17-18-19-30-31-32

On request all the MEDESYS dental clamps are available with a special anti-reflection treatment to ensure a better and clearer view during surgery (particularly indicated with dental photograph). For ordering just add "S" after the code article. Example: 5595/56 > 5595/56S

Su richiesta è possibile ottenere tutti i ganci per diga MEDESYS con trattamento superficiale anti-riflesso per migliorare la visibilità in campo operatorio (particolarmente indicato per fotografie odontoiatriche). Aggiungere la lettera "S" dopo il codice articolo. Esempio: 5595/56 > 5595/56S



Example standard finish
Esempio finitura standard
5595/56



Example satin finish
Esempio finitura satinata
5595/56S



RESTORATIVE / CONSERVATIVA

LOWER MOLARS MOLARI INFERIORI



5595/3
Flat jaws for small lower molars

Tooth / Dente:
17-18-19-30-31-32



5595/7
Flat jaws for general purposes
on lower molars

Tooth / Dente:
17-18-19-30-31-32



5595/56
Festooned jaws for
large lower molars

Tooth / Dente:
17-18-19-30-31-32



5595/12A
Serrated jaws for lower right molars and
partially erupted (and some) upper left

Tooth / Dente:
14-15-16-30-31-32



5595/13A
Serrated jaws for lower left molars and
partially erupted (and some) upper right

Tooth / Dente:
1-2-3-17-18-19



5595/202
Flat and large jaws for
large lower molars

Tooth / Dente:
17-18-19-30-31-32



5595/203
Small jaws for small right molars

Tooth / Dente:
30-31-32



5595/204
Small jaws for small left molars

Tooth / Dente:
17-18-19

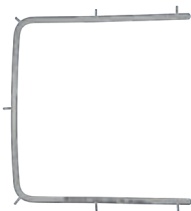

5554 (mm 80 × 90)
Rubber dam frame small
Telaio per diga piccolo

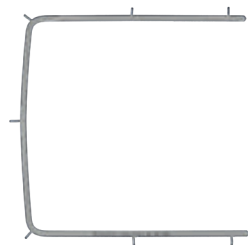

5553 (mm 110 × 110)
Rubber dam frame medium
Telaio per diga medio

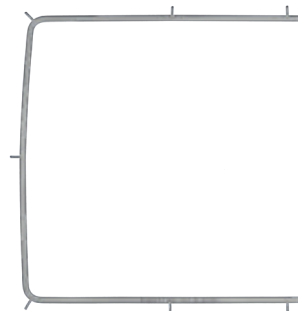

5552 (mm 140 × 140)
Rubber dam frame large
Telaio per diga grande



5605
St. Steel rubber dam clamps tray
Vassoio porta uncini in acciaio inox

UPPER JAW / ARCATA SUPERIORE

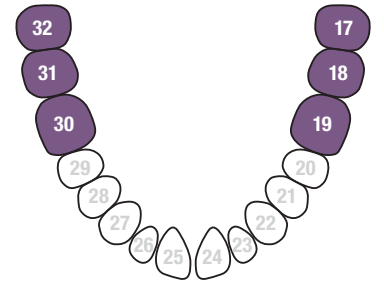
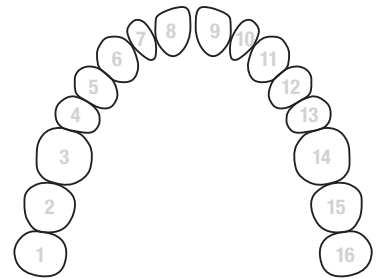

LOWER JAW / ARCATA INFERIORE

UPPER MOLARS

MOLARI SUPERIORI



UPPER JAW / ARCATA SUPERIORE



5595/4
Festooned jaws for small upper molars
Tooth / Dente:
1-2-3-14-15-16



5595/5
Festooned jaws for large upper molars. Jaws fit the gum curvature
Tooth / Dente:
1-2-3-14-15-16



5595/8
Festooned jaws for general purposes on upper molars. Jaws fit the gum curvature
Tooth / Dente:
1-2-3-14-15-16

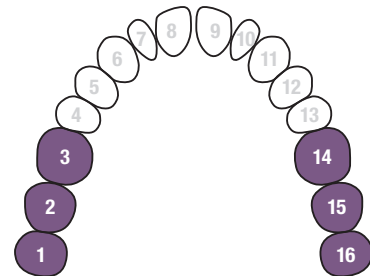

5595/201
Festooned jaws for upper molars
Tooth / Dente:
1-2-3-14-15-16



5595/205
Festooned jaws for large upper molars
Tooth / Dente:
1-2-3-14-15-16

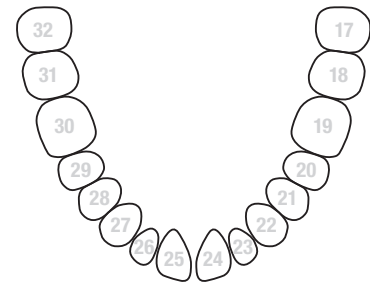

LOWER JAW / ARCATA INFERIORE

1675/10

Rubber dam kit
Kit per diga dentale

Content / Contenuto:

- 981/20 Gammafix tray Cinc
- 5550 Rubber dam punch
- 5551 Clamp plier
- 5552 Rubber dam frame
- 5553 Rubber dam frame
- 5554 Rubber dam frame
- 5595/00 Clamp N. 00
- 5595/3 Clamp N. 3
- 5595/4 Clamp N. 4
- 5595/12A Clamp N. 12A
- 5595/13A Clamp N. 13A
- 5595/27 Clamp N. 27
- 5595/29 Clamp N. 29
- 5595/210 Clamp N. 210
- 5595/212 Clamp N. 212
- 5595/W8A Clamp N. W8A
- 5605 Clamps tray
- 5610/M-V Rubber dam box (not shown)

Content can be changed upon request
Su richiesta il contenuto può essere cambiato

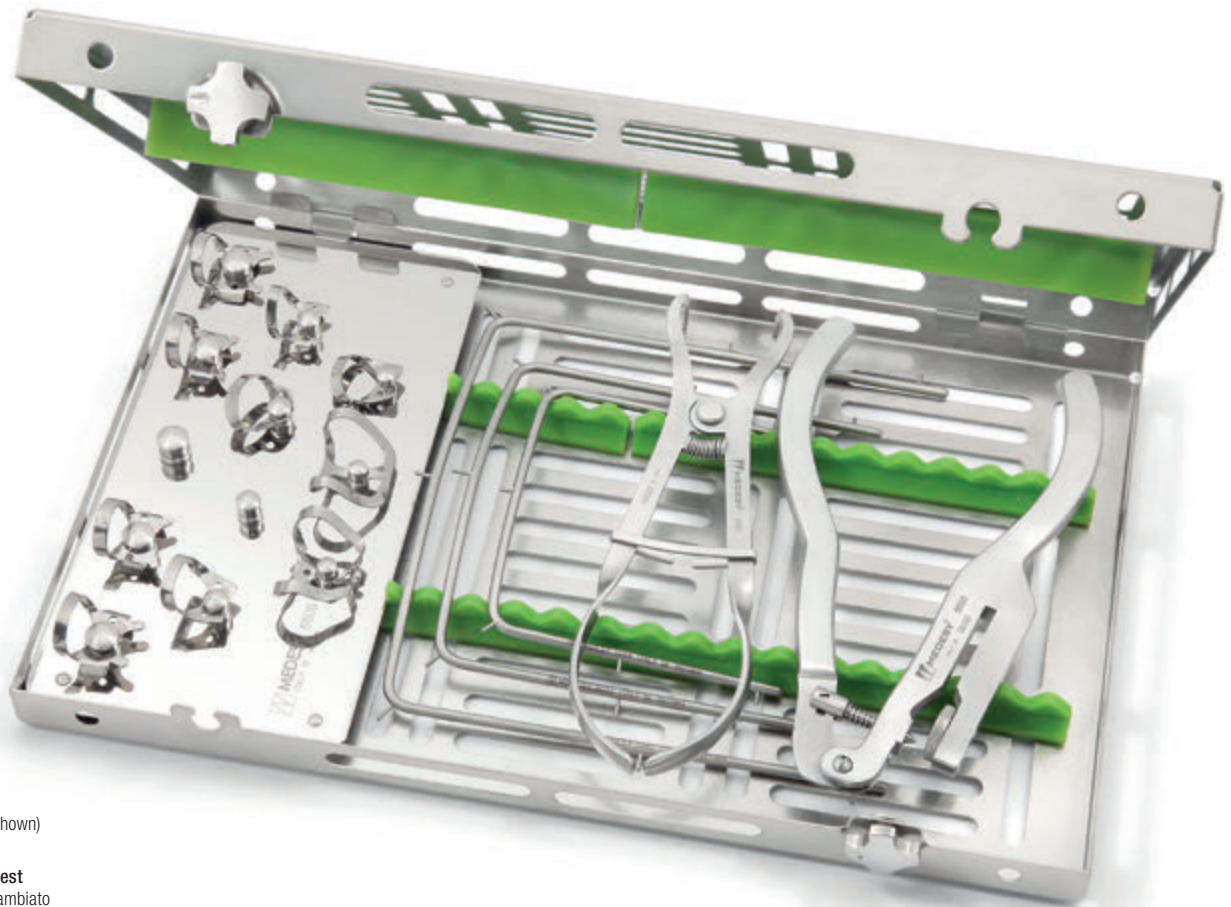

RESTORATIVE / CONSERVATIVA

CLAMPS FORCEPS PINZE PER UNCINI



5551 (mm 170)
Ivory



2823 (mm 150)
For small clamps
Per uncini piccoli



5580 (mm 175)
Washington



5570 (mm 175)
Brewer



5590 (mm 175)
White

RUBBER DAM PUNCH PINZE FORA DIGA



5560/2 (mm 170)
Ainsworth

Available with smooth handle (code **5560/1**)
Disponibile con manico liscio (codice **5560/1**)



5550 (mm 160)
Ivory

CROWN REMOVERS

MARTELLETTI LEVA CORONE



4569 in kit with:
4569/1
4569/2
4569/3

Adjustable intensity of the impulse
by twisting the round serrated knob
Intensità di forza regolabile girando
l'apposita rotellina zigrinata



Spare parts
upon request
Parti di ricambio
su richiesta



4569 (mm 155)
Automatic crown remover
Togli corone automatico

4569/1

4569/2

4569/3

4569/4
Single loop
Cavo corto

4569/6
Double loop
Cavo lungo



4572 in kit with:
4572/1
4571/2

(1:1 scale / scala 1:1)

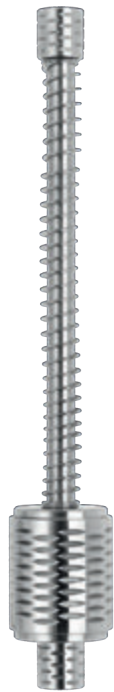

4570 in kit with:
4571/1
4571/2
4571/3



4571 in kit with:
4571/1
4571/2
4571/3

(1:1 scale / scala 1:1)



4572 (mm 150)
Automatic crown remover
Togli corone automatico

4572/1

4572/2

4570 (mm 145)
With spring, single end
Con molla, singolo filetto

4571 (mm 180)
With double end
Con doppio filetto

4571/1

4571/2

4571/3



RESTORATIVE / CONSERVATIVA

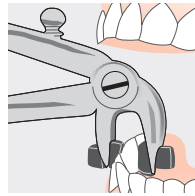

For ceramical and plastic crowns and bridges, with plastic inserts (sterilization up to 180° C).
 Per ponti e corone in ceramica o plastica, inserti sterilizzabili fino a 180° C.



4564 (mm 160)

4563

1 pair plastic inserts
 1 paio inserti di plastica



4565 (mm 145)



Universal plier for bridges and crowns removing, with positioning screw and internal spring. It is generally used with adhesive powder to increase the grip on the crown.

Pinza universale per la rimozione di ponti e corone, con vite di posizionamento e molla interna. Di norma si utilizza con la polvere adesiva per aumentare la presa sulla corona.



4562 (mm 140)

Universal plier for the removal of ceramic crowns and bridges
 Strumenti per estrarre le corone

4562/1

Kit 3 pair plastic inserts
 Kit 3 paia inserti di plastica



Plier Wynman, for placing and removing temporary crowns and bridges in tight spaces.
 Pinza Wynman, adatta per collocare e rimuovere ponti e corone in spazi molto ristretti.

4568/TC (mm 160)
 Wynman



Copper ring removing plier.
 Pinza per rimozione anelli di rame.

4576/R
 Straight
 Retta

4576/A (mm 150)
 Furrer
 Curved
 Curva

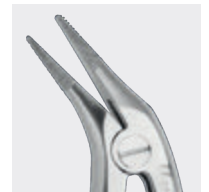

Pliers for telescope crowns. Diamond points coated.
 Pinze per corone telescopiche. Punte rivestite in diamante.



4573/D (mm 125)
4574/D (mm 150)
 Böhm

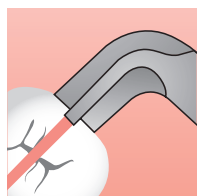

4577/2

4577/3



4577/4



4577/1
Universal
Universale



4575 (mm 175)
Bergh
Crown opener
Pinza apricorone



4567/R
Spare blade
Lama di ricambio

4567 (mm 180)
Montfort
Crown slitter
Tagliacorone

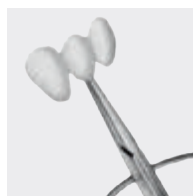

Crowns and bridges holding plier, with ring.
Pinza porta ponti e corone,
con anello di supporto.

1580 (mm 125)

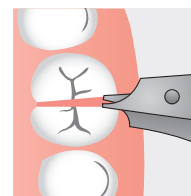
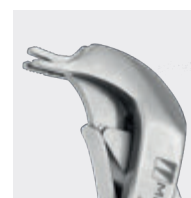

Crown opener plier: it allows to open and remove the crown in a quick and easy way. Insert the serrated tips in the line (previously made with a bur) and operate the lever.

Pinza apri-corone: consente di aprire e quindi rimuovere la corona in modo semplice e veloce. Inserire le punte zigrinate nel solco (precedentemente creato con una fresa) ed azionare la pinza.

4566 (mm 150)
Crown opener
Apricorone



PLUGGERS ISO SIZED

COMPATTATORI ENDODONTICI A MISURE ISO

542/1.C6

(1:1 scale / scala 1:1)



ø 0,3 mm

ø 0,4 mm

ø 0,5 mm

ø 0,6 mm

ø 0,8 mm

ø 1,0 mm

ø 1,2 mm



542/1.C6

ISO 30

Blue
Blu

542/2.C6

ISO 40

Black
Nero

542/3.C6

ISO 50

Yellow
Giallo

542/4.C6

ISO 60

Blue
Blu

542/5.C6

ISO 80

Black
Nero

542/6.C6

ISO 100

Yellow
Giallo

542/7.C6

ISO 120

Blue
Blu

PLUGGERS



PLUGGER: recognizable from its flat tip available in different diameters; its main function is that of vertically plugging and condensing the guttaperca into the endodontic canal.

PLUGGER: si riconosce per la punta piatta, articolata in vari diametri; la funzione principale è di compattare per condensare la guttaperca verticalmente all'interno del canale endodontico.

542/KIT

Content / Contenuto:

542/2.C6

542/3.C6

542/4.C6

542/5.C6

542/6.C6

Content can be changed upon request

Su richiesta il contenuto può essere cambiato



“ MEDESYS IN SPOT

The Spreaders and Pluggers have an ISO color coded ring for a better identification.

Compattatori endodontici e strumenti canalari hanno un anello colorato a norma ISO per una migliore identificazione.

(ISO= International Organization for Standardization)

ISO 20: Yellow – Giallo

ISO 30: Blue – Blu

ISO 40: Black – Nero

ISO 50: Yellow – Giallo

ISO 60: Blue – Blu

ISO 80: Black – Nero

ISO 100: Yellow – Giallo

ISO 120: Blue – Blu

”

SPREADERS ISO SIZED

STRUMENTI CANALARI A MISURE ISO



543/3.C6
(1:1 scale / scala 1:1)



Flexible point for easy access into the endodontic canal.

Punta flessibile per un migliore accesso nel canale endodontico.

ISO color code ring, new extension code .C6

Anello colore ISO, con nuova codifica .C6

Dalila 6 mm handle with satin finish.

Manico Dalila 6 mm con finitura satinata.

ø 0,2 mm ø 0,3 mm ø 0,4 mm ø 0,5 mm ø 0,6 mm

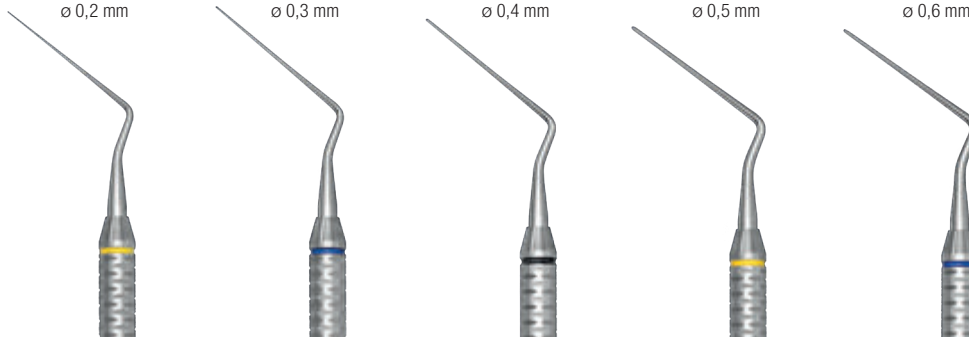

543/1.C6

ISO 20

Yellow
Giallo

543/2.C6

ISO 30

Blue
Blu

543/3.C6

ISO 40

Black
Nero

543/4.C6

ISO 50

Yellow
Giallo

543/5.C6

ISO 60

Blue
Blu

SPREADERS

SPREADER: recognizable from its pointed tip and its stem, which is bended in many different ranges. The spreader is mostly used for the following applications: *cold working* to laterally compact the guttaperca into the endodontic canal; *heat carrier* to carry the heat into the endodontic canal through a previously heated tip.

SPREADER: si riconosce per la punta aguzza e stelo piegato in varie gradazioni. Le metodologie di applicazione più comuni sono: *uso a freddo* la cui funzione è di compattare lateralmente il cono master di guttaperca contro la parete del canale endodontico ricavando lo spazio per introdurre i coni accessori; *porta calore* la cui funzione è appunto di portare calore nel canale endodontico per mezzo della punta precedentemente scaldata.

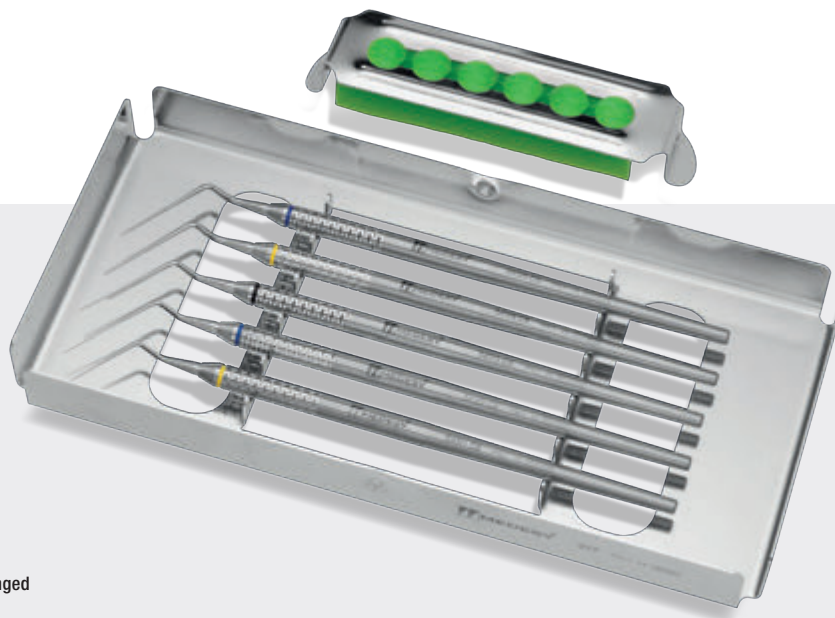

543/KIT

Content / Contenuto:

543/1.C6

543/2.C6

543/3.C6

543/4.C6

543/5.C6

Content can be changed upon request

Su richiesta il contenuto può essere cambiato



RESTORATIVE / CONSERVATIVA



540/1
Luks N. 1

540/2
Luks N. 2

540/3
Luks N. 3

540/4
Luks N. 4

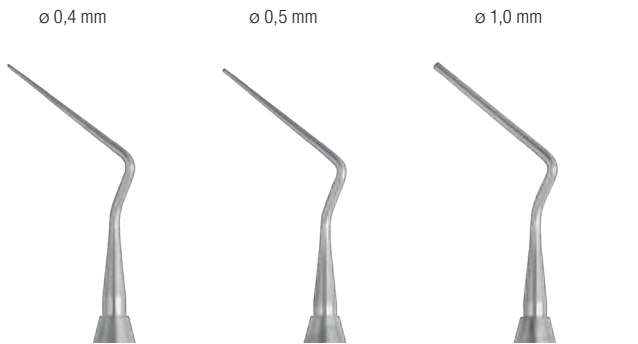

544/1-3
Plugger 1/3

544/5-7
Plugger 5/7

544/9-11
Plugger 9/11



ø 0,45 mm

ø 0,75 mm

ø 1,15 mm



545/1
Glick Blade
Plugger

538/1
Retro filling plugger N. 1

538/2
Retro filling plugger N. 2



ø 1,2 mm

ø 0,80 mm

ø 1,10 mm

HEAT CARRIERS SPREADERS

STRUMENTI CANALARI



(1:1 scale / scala 1:1)

ø 0,25 mm

ø 0,25 mm

ø 0,40 mm

ø 0,20 mm

ø 0,35 mm

ø 0,55 mm

ø 0,35 mm

POSTERIOR DESIGN
PER POSTERIORI



539/1

Spreaders 1S

539/2

Spreaders 2S

539/3

Spreaders D11

539/4

Spreaders MA-57

539/5

Spreaders 0

539/6

Spreaders 00

539/7

Spreaders 3



RESTORATIVE / CONSERVATIVA

(1:1 scale / scala 1:1)

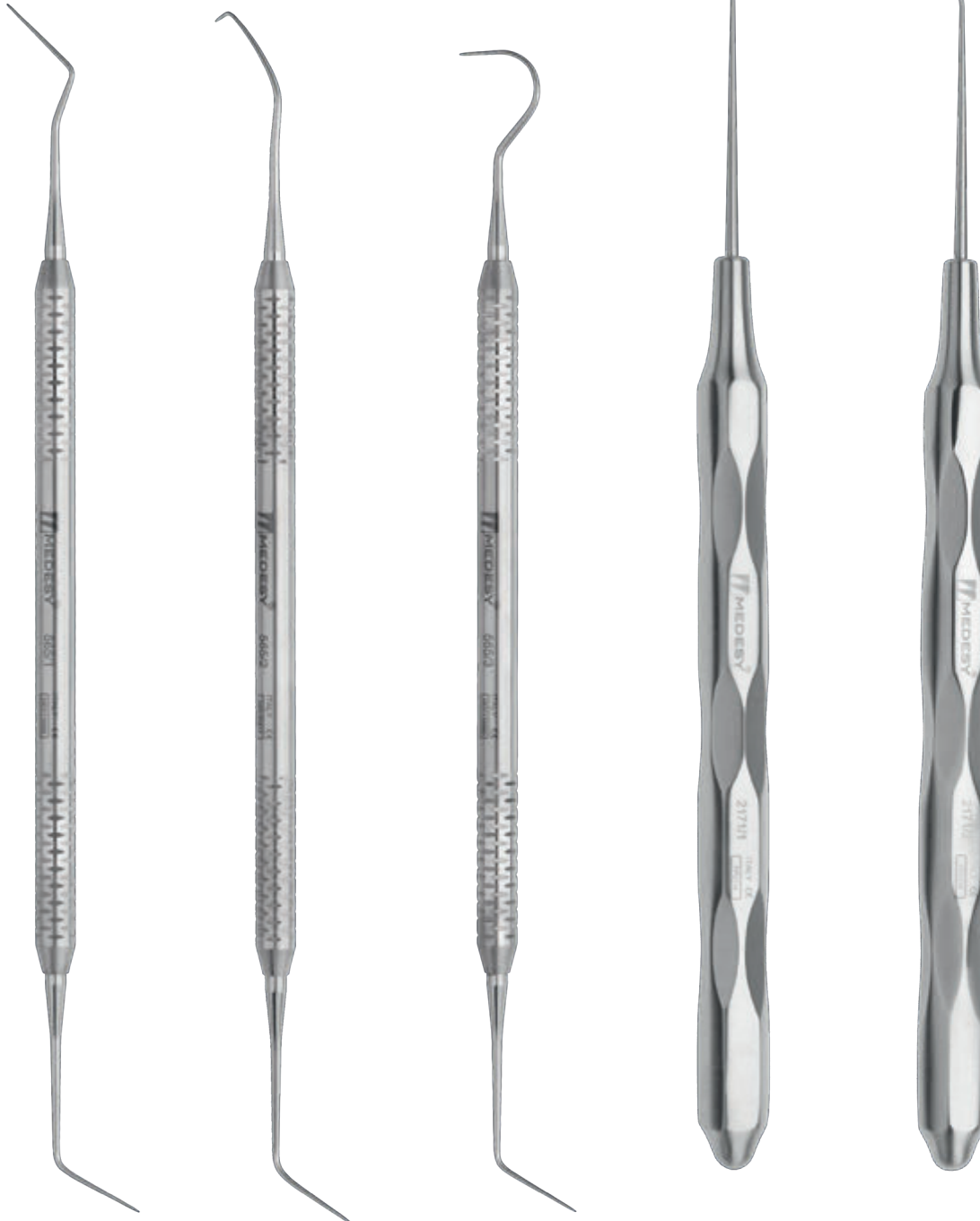

The micro probe, thanks to its long and pointed tip, can be deeply inserted into the endodontic canal. It gives a better visibility when working with the microscope. The main application is the identification of access into root canals and to establish the position and the blocking force of broken endodontic instruments (as well as of silver pins) in root canals.

Grazie al lungo stelo ed alla punta particolarmente aguzza, questo specillo può essere inserito in profondità all'interno del canale endodontico. Non ostacola la visuale se utilizzato con il microscopio. La funzione principale è di identificare l'accesso nei canali e di stabilire l'esatta posizione degli strumenti endodontici rotti (così anche coni di argento) all'interno dei canali.

565/1
DG 6A/6

565/2
DG 17/6

565/3
DG 23/6

2171/1 (mm 205)

2171/2 (mm 195)

ENDODONTIC EXCAVATORS

ESCAVATORI ENDODONTICI



665/12
(1:1 scale / scala 1:1)



ø 1,5 mm



665/11
Round
Tondo

ø 2,5 mm



665/12
Round
Tondo

ø 3,0 mm



665/13
Round
Tondo

ø 1,0 mm



665/21
Blade thin
Lama sottile

ø 2,0 mm



665/22
Blade medium
Lama media

ø 3,0 mm



665/23
Blade large
Lama larga



RESTORATIVE / CONSERVATIVA



The thin and long tips bent at 60° against the handle enable the instrument to be introduced deeply into the root canal. The total length of the tips is 20 mm with a diameter of 0.8 mm.

Le punte assottigliate e curvate a 60° rispetto l'asse dell'impugnatura, permettono alla pinza di essere introdotta in profondità nel canale. La lunghezza totale delle punte è di 20 mm con un diametro di 0.8 mm.

(1:1 scale / scala 1:1)

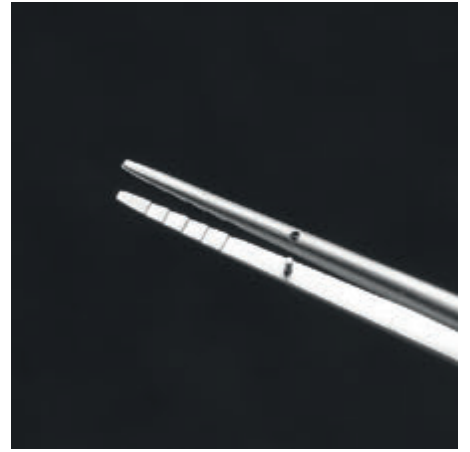

The forceps have been equipped with a special set of serrated edges positioned at an acute angle, which enables a firm seizing of a broken instrument, or a silver pin in the root canal. The total length of the serrated working part is 5 mm.

La speciale zigrinatura con angoli acuti assicura una presa perfetta del frammento o della punta, all'interno del canale. La lunghezza totale della parte zigrinata è di 5 mm.

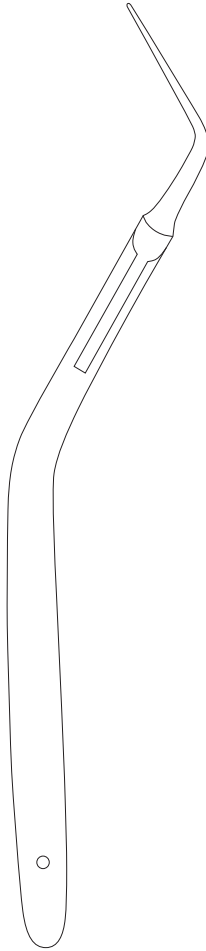

The internal pin prevents the side slipping of the tips.
Il rivetto interno evita l'accavallarsi delle punte.

2168 (mm 125)

Forceps for removing broken instruments
Pinza per rimuovere strumenti canalari rotti



4902/MM (mm 125)
Mirror handle with millimeter scale
 Manico per specchietto con scala millimetrata

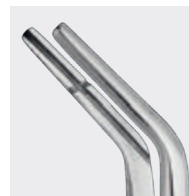

**Crossed grooved
 for holding points**
 Zigrinatura incrociata
 per trattenere le punte

1019 (mm 150)
Pin holding tweezers, with lock
 Pinzetta per pins, con fermo



2162/C (mm 135)
Curved
 Curva

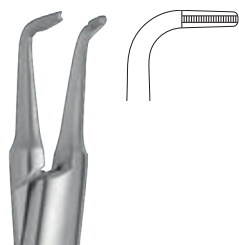

2162/A (mm 130)
Angled 90°
 Angolata 90°

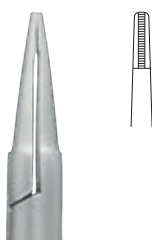

2162/R (mm 135)
Straight
 Retta

**Forceps for pins
 and broken nerve**
 Pinza per strumenti
 canalari e frammenti



2170 (mm 125)
 Peet



LARGE / GRANDE

mm 204 × 105 × 54

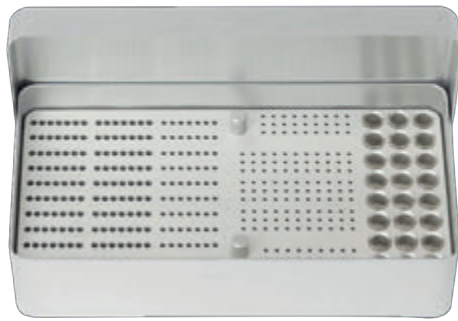

985
 Silver
 Argento

210 × MI
 153 × RA
 24 × TUBE



986
 Blue
 Blu

272 × MI

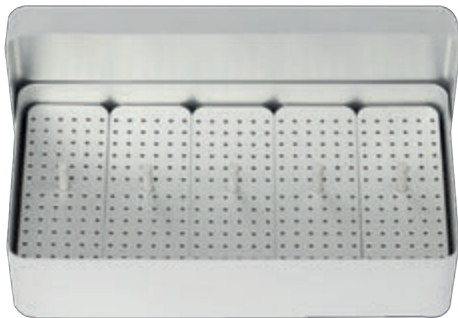

987
 Silver
 Argento

360 × MI



988
 Silver + 3 colors
 Argento + 3 colori

96 × FG
 48 × RA
 48 × MIX
 12 × TUBE

MEDIUM / MEDIA

mm 125 × 105 × 54



989
 Silver
 Argento

216 × MI



990
 Silver-Blue
 Argento-Blu

87 × MI
 12 × TUBE

“ MEDESY IN SPOT

FG = Friction grip
Frese per turbina

RA = Right angle
Manipolo contrangolo

MI = Manual instruments
Strumenti manuali

”

SMALL / PICCOLA

mm 104 × 44 × 54



991
Red-Silver
Rosso-Argento
24 × RA
24 × MI
4 × TUBES



992
Silver
Argento
72 × MI



995
Green-Silver
Verde-Argento
72 × MI



993
Silver
Argento
12 × TUBES



994
Silver-Red
Argento-Rosso
24 × RA
24 × MI



996
Blue
Blu
48 × MI



997
Silver-Yellow
Argento-Giallo
48 × RA

ROUND / TONDA

mm ø 48 × h 62



6201/V
Green / Verde
18 × MI



6201/D
Yellow / Giallo
18 × MI



6204/R
Red / Rosso
6 × TUBE



6204/G
Silver / Argento
6 × TUBE

ROUND / TONDA

mm ø 94 × h 70



6200
Silver / Argento
64 × MI
4 × TUBE



CANAL INSTRUMENT / MILL HOLDER
PORTA FRESE / PORTA STRUMENTI CANALARI

mm 75 × 40



967/1
48 × FG

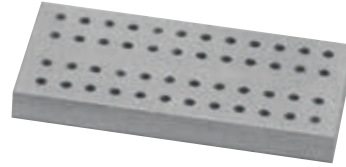

967/2
48 × RA

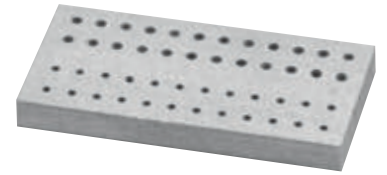

967/3
24 × FG
24 × RA

MILL HOLDER
PORTA FRESE

mm 60 × 40

(Sold with lid)
 (Venduti con coperchio)

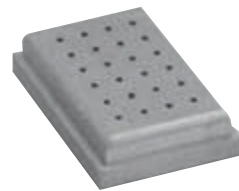

965/1
24 × FG

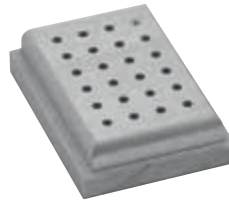

965/2
24 × RA



965/3
12 × FG
12 × RA

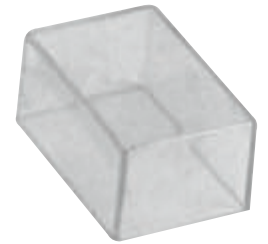

965/4
Lid, not autoclavable
 Coperchio, non autoclavabile

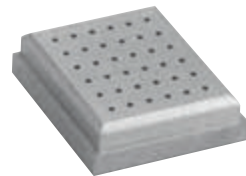

966/1
36 × FG

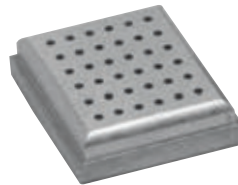

966/2
36 × RA



966/3
18 × FG
18 × RA



966/4
Lid, not autoclavable
 Coperchio, non autoclavabile

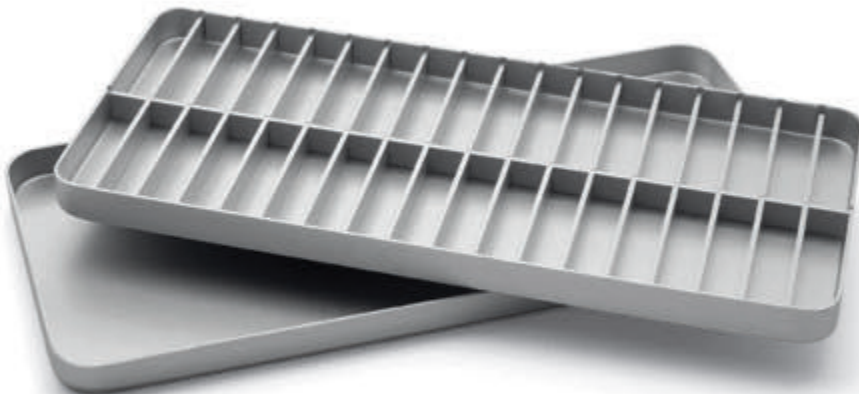

1003

Endodontic tray with lid, aluminium
 Vassoio per endodonzia con coperchio, alluminio
 mm 257 × 116 × 16

ENDOMETER, ALUMINIUM
MISURATORE PER STRUMENTI CANALARI, ALLUMINIO



6150
 ø mm 34 – h mm 48
 Silver-Blue / Argento-Blu



With locking screw
 Con vite di fissaggio



6160/R
 mm 100 × 40 × 40
 Red / Rosso

6160/B
 mm 100 × 40 × 40
 Blue / Blu

6160/G
 mm 100 × 40 × 40
 Silver / Argento

6152
 ø 40 mm × h 30 mm
Aluminium endodontic instruments cleaners
 Pulitori per strumenti canalari in alluminio

6152/SCR
 Spare part
 Spugna di ricambio

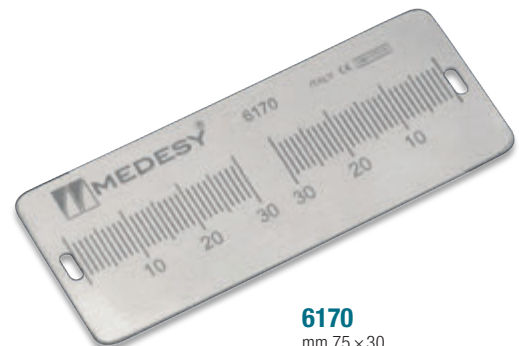

6170
 mm 75 × 30
Endodontic ruler inox
 Stecca endodontica inox



RESTORATIVE / CONSERVATIVA

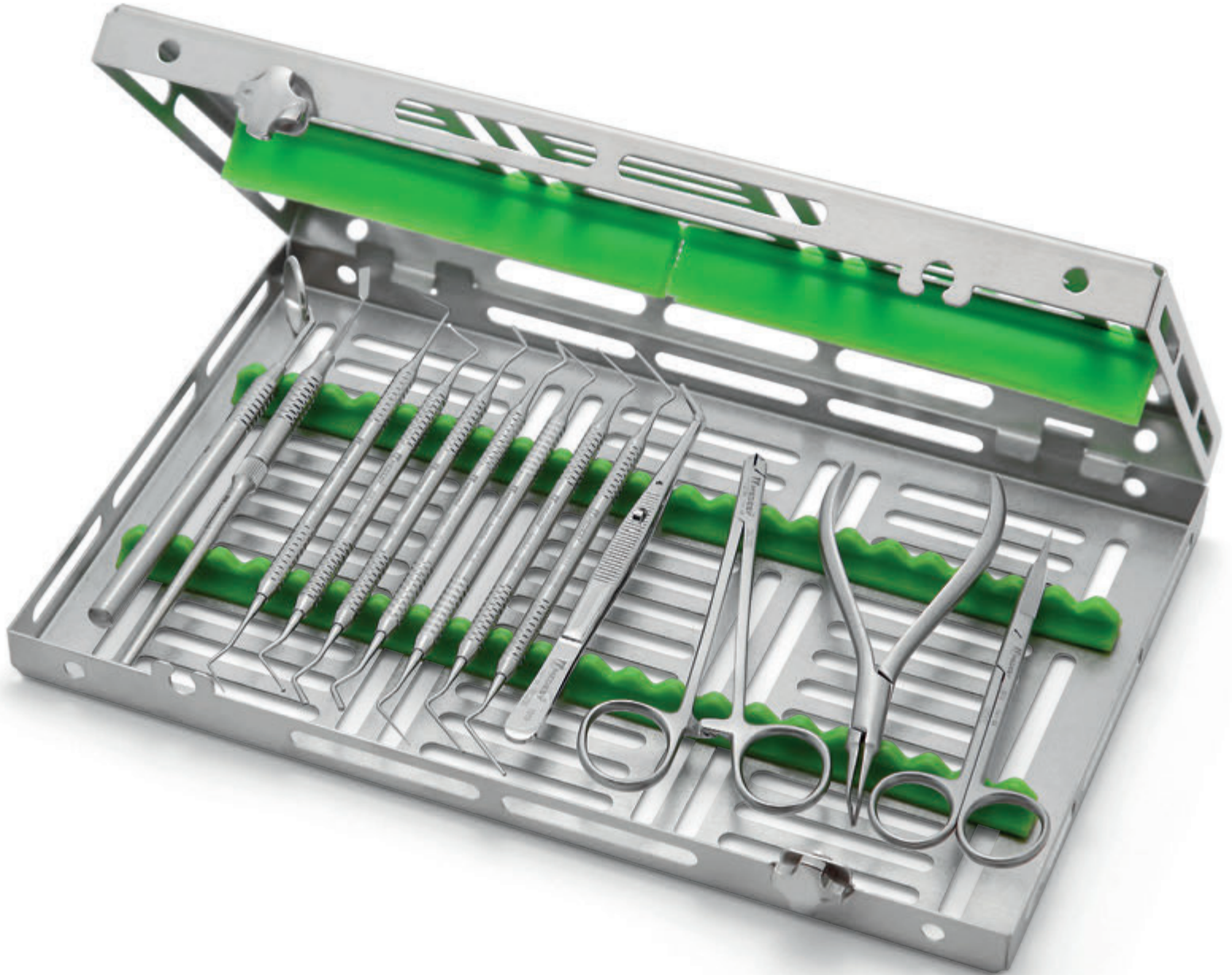

1675/9

Kit endodontic
Kit endodontico

Content / Contenuto:

1019	Pin holding tweezer
2164	Stieglitz forceps
3519	Goldman-Fox scissors
2162/C	Pins forceps
3638 + 4908/Q	Micro blades holer + micro mirror
4905/8 + 4903/4	Mirror handle + Mirror #4
530/2	Plugger MT2R
530/3	Plugger MT3R
544/1-3	Endodontic plugger
544/5-7	Endodontic plugger
544/9-77	Endodontic plugger
565/1	Endodontic explorer
665/31	Endodontic excavator
981/20	Gammatrix tray Cinc



OSTEOTOMES, MEDOSS LINE

OSTEOTOMI, LINEA MEDOSS



8 mm
10 mm
12 mm
14 mm
16 mm
18 mm

Straight
Retto

- 1321/1** (ø 2,0 / 2,7 mm)
- 1321/2** (ø 2,7 / 3,2 mm)
- 1321/3** (ø 3,2 / 3,7 mm)
- 1321/4** (ø 3,7 / 4,2 mm)
- 1321/5** (ø 4,2 / 5,0 mm)

Convex
Convesso

1321/3 (mm 170)

A new tip for the osteotomes of the line Medoss: the terminal portion is now conical to facilitate the insertion in the sinus cavity and has minimal/maximal diameter scale, progressive depth markings from 8 to 18 mm, by 2 mm steps.

Nuova punta degli osteotomi linea Medoss: il terminale è ora conico per agevolare l'inserimento nella cavità, avente diametro minimo e massimo; le tacche di profondità hanno scala da 8 a 18 mm, con step di 2 mm.

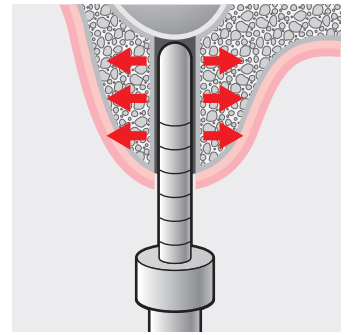

SINUS CONDENSING

Osteotomes conceived to compact the bone before the placement of an implant and aiming at reaching greater density, which is better for initial implant support. Thanks to the new conical shape with increasing diameters the bone condensation is obtained both laterally and apically. The terminal conical portion is slightly rounded to reduce the risk of perforation of the Schneiderian membrane.

Osteotomi progettati per compattare l'osso, prima dell'inserimento dell'impianto. La compattazione avviene sia in senso laterale che verticale, grazie alla nuova forma conica e progressiva della punta. Il terminale è arrotondato per ridurre il rischio di perforare la membrana di Schneider.

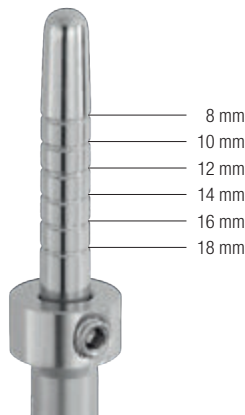

8 mm
10 mm
12 mm
14 mm
16 mm
18 mm

Bayonet
Baionetta

- 1321/6** (ø 2,0 / 2,7 mm)
- 1321/7** (ø 2,7 / 3,2 mm)
- 1321/8** (ø 3,2 / 3,7 mm)
- 1321/9** (ø 3,7 / 4,2 mm)
- 1321/10** (ø 4,2 / 5,0 mm)

Convex
Convesso

1321/8 (mm 165)



1321/KIT

Kit sinus condensing
Kit osteotomi convessi

Content / Contenuto:

5 osteotomes straight and
5 osteotomes bayonet, convex

5 osteotomi retti e
5 osteotomi a baionetta, convessi

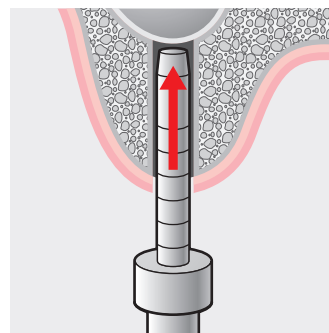

SINUS ELEVATION

Osteotomes conceived to prepare the implant site. The specific tip shape with cutting edges enables as bone grafting on the implant cavity. Concave (Cupped-ended) osteotomes are used to collect and compress bone into the apical end of the osteotomy. A far less invasive technique compared to the Sinus lift obtained by performing a "later window" approach.

Osteotomi progettati per preparare il sito implantare. La forma della punta permette di innestare l'osso della cavità e di trasportarlo alla sommità, grazie ai bordi taglienti e al terminale concavo. Tecnica meno invasiva rispetto la "lateral window".

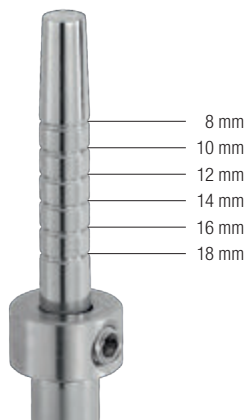

Straight
Retto

- 1322/1** (ø 2,0 / 2,7 mm)
- 1322/2** (ø 2,7 / 3,2 mm)
- 1322/3** (ø 3,2 / 3,7 mm)
- 1322/4** (ø 3,7 / 4,2 mm)
- 1322/5** (ø 4,2 / 5,0 mm)

Concave
Concavo

1322/3 (mm 170)

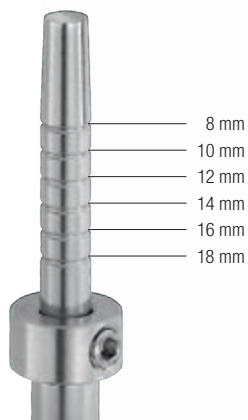

Bayonet
Baionetta

- 1322/6** (ø 2,0 / 2,7 mm)
- 1322/7** (ø 2,7 / 3,2 mm)
- 1322/8** (ø 3,2 / 3,7 mm)
- 1322/9** (ø 3,7 / 4,2 mm)
- 1322/10** (ø 4,2 / 5,0 mm)

Concave
Concavo

1322/8 (mm 165)



1322/KIT

Kit sinus elevation (internal)
Kit rialzo del seno mascellare

Content / Contenuto:

**5 osteotomes straight and
5 osteotomes bayonet, concave**

5 osteotomi retti e
5 osteotomi a baionetta, concavi





Straight
Retto

- 1323/1** (ø 2,7 mm)
- 1323/2** (ø 3,2 mm)
- 1323/3** (ø 3,7 mm)
- 1323/4** (ø 4,2 mm)
- 1323/5** (ø 5,0 mm)

Pointed
A punta

1323/3 (mm 170)

“ MEDESY IN SPOT

Color codes for the new osteotomes.

Codice colore per i nuovi osteotomi. ”

- **White** / Bianco – ø 2,0 / 2,7 mm
- **Blue** / Azzurro – ø 2,7 / 3,2 mm
- **Yellow** / Giallo – ø 3,2 / 3,7 mm
- **Orange** / Arancio – ø 3,7 / 4,2 mm
- **Red** / Rosso – ø 4,2 / 5,0 mm

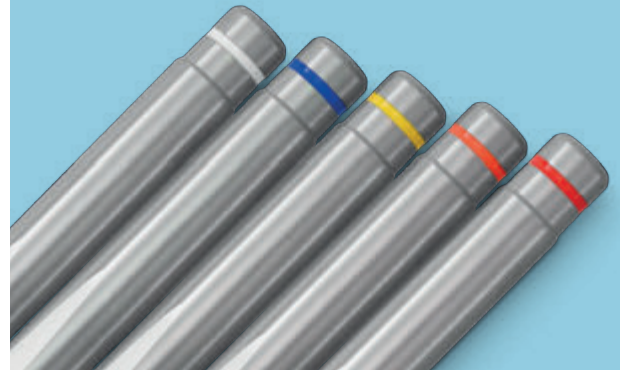

Bayonet
Baionetta

- 1323/6** (ø 2,7 mm)
- 1323/7** (ø 3,2 mm)
- 1323/8** (ø 3,7 mm)
- 1323/9** (ø 4,2 mm)
- 1323/10** (ø 5,0 mm)

Pointed
A punta

1323/8 (mm 165)

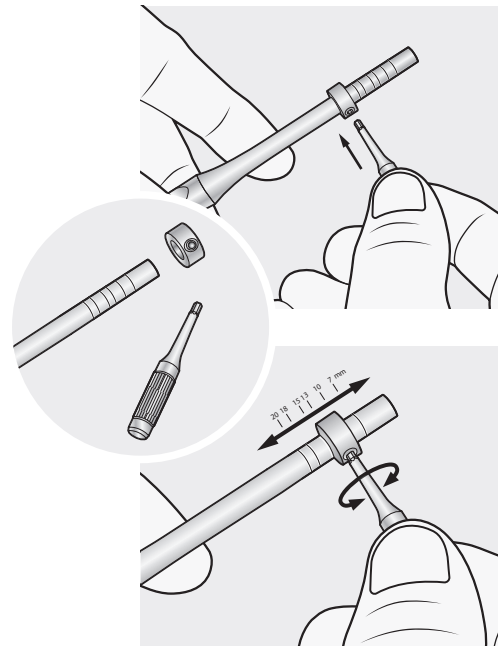

New MEDOSS osteotomes, equipped with a practical and easy blocking device extremely compact if compared to the traditional system thus ensuring a larger visual and operative field. The supplied screwdriver operates the locking and unlocking on the osteotome stopping device.

Nuovi osteotomi MEDOSS, progettati con un semplice e pratico sistema di bloccaggio: tale sistema è estremamente compatto se confrontato con il sistema tradizionale, aumentando il campo visivo ed operativo. Il cacciavite fornito in dotazione serve a bloccare e sbloccare il sistema di stop dell'osteotomo.



1305/KIT

Kit osteotomes
Kit osteotomi

Content / Contenuto:

1321/3	Osteotome \varnothing 3,2 / 3,7 mm convex
1322/3	Osteotome \varnothing 3,2 / 3,7 mm concave
1321/8	Osteotome \varnothing 3,2 / 3,7 mm convex bayonet
1322/8	Osteotome \varnothing 3,2 / 3,7 mm concave bayonet
1309/1	Sinus lift n. 1
1309/2	Sinus lift n. 2
1309/3	Sinus lift n. 3
661/87.HL8	Bone curette Lucas n. 87
661/88.HL8	Bone curette Lucas n. 88
980/10	Gammatrix tray Tre

Content can be changed upon request
Su richiesta il contenuto può essere cambiato



OSTEOTOMES, IMPLANT SITE DILATATORS

OSTEOTOMI, DILATATORI DEL SITO IMPLANTARE



1300/2 (mm 155)

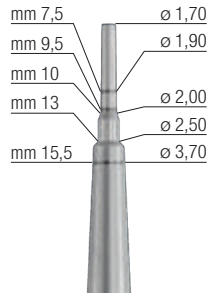

1300/1

∅ 1,60-3,60 mm

Concave
Concavo

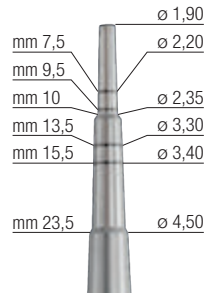

1300/2

∅ 1,90-4,50 mm

Concave
Concavo

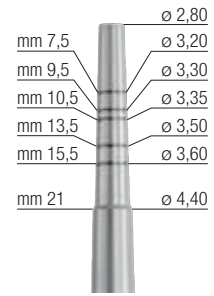

1300/3

∅ 2,80-4,40 mm

Concave
Concavo

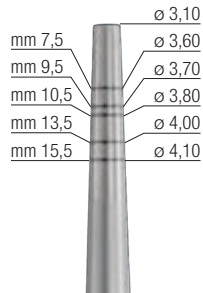

1300/4

∅ 3,10-4,30 mm

Concave
Concavo

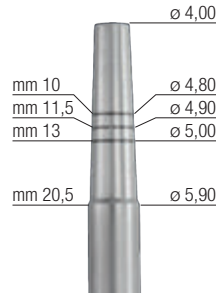

1300/5

∅ 3,90-6,30 mm

Concave
Concavo

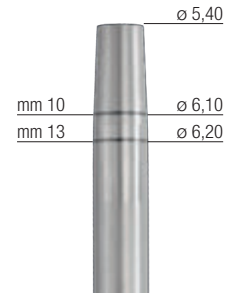

1300/6

∅ 5,50-6,30 mm

Concave
Concavo



1300/KIT

Kit implant site dilators
Kit dilatori del sito implantare

Content / Contenuto:

- 1300/1** Osteotome n.1
- 1300/2** Osteotome n.2
- 1300/3** Osteotome n.3
- 1300/4** Osteotome n.4
- 1300/5** Osteotome n.5
- 1300/6** Osteotome n.6
- 980/9** Gammafix tray Doi



ø 26 mm
320 gr

950

Mead
mm 175

Teflon spare parts (950/R)

Inserti in teflon intercambiabili (950/R)



ø 22 mm
170 gr

951

Partsch
mm 175

Hollow handle

Manico vuoto



ø 28 mm
320 gr

952

Mead
mm 180

Teflon spare parts (952/R)

Inserti in teflon intercambiabili (952/R)



ø 20 mm
150 gr

952/20

Medesy
mm 170

Teflon spare parts (952/20R)

Inserti in teflon intercambiabili (952/20R)



ø 25 mm
190 gr

952/25

Medesy
mm 170

Teflon spare parts (952/25R)

Inserti in teflon intercambiabili (952/25R)

SINUS LIFT INSTRUMENTS

STRUMENTI PER IL RIALZO SENO MASCELLARE



1304/KIT

Kit sinus lift
Kit rialzo del seno mascellare

Content / Contenuto:

1304/901	Sinus lift n.901
1304/902	Sinus lift n.902
1304/903	Sinus lift n.903
1304/904	Sinus lift n.904
1304/905	Sinus lift n.905
977	Tray

(1:1 scale / scala 1:1)

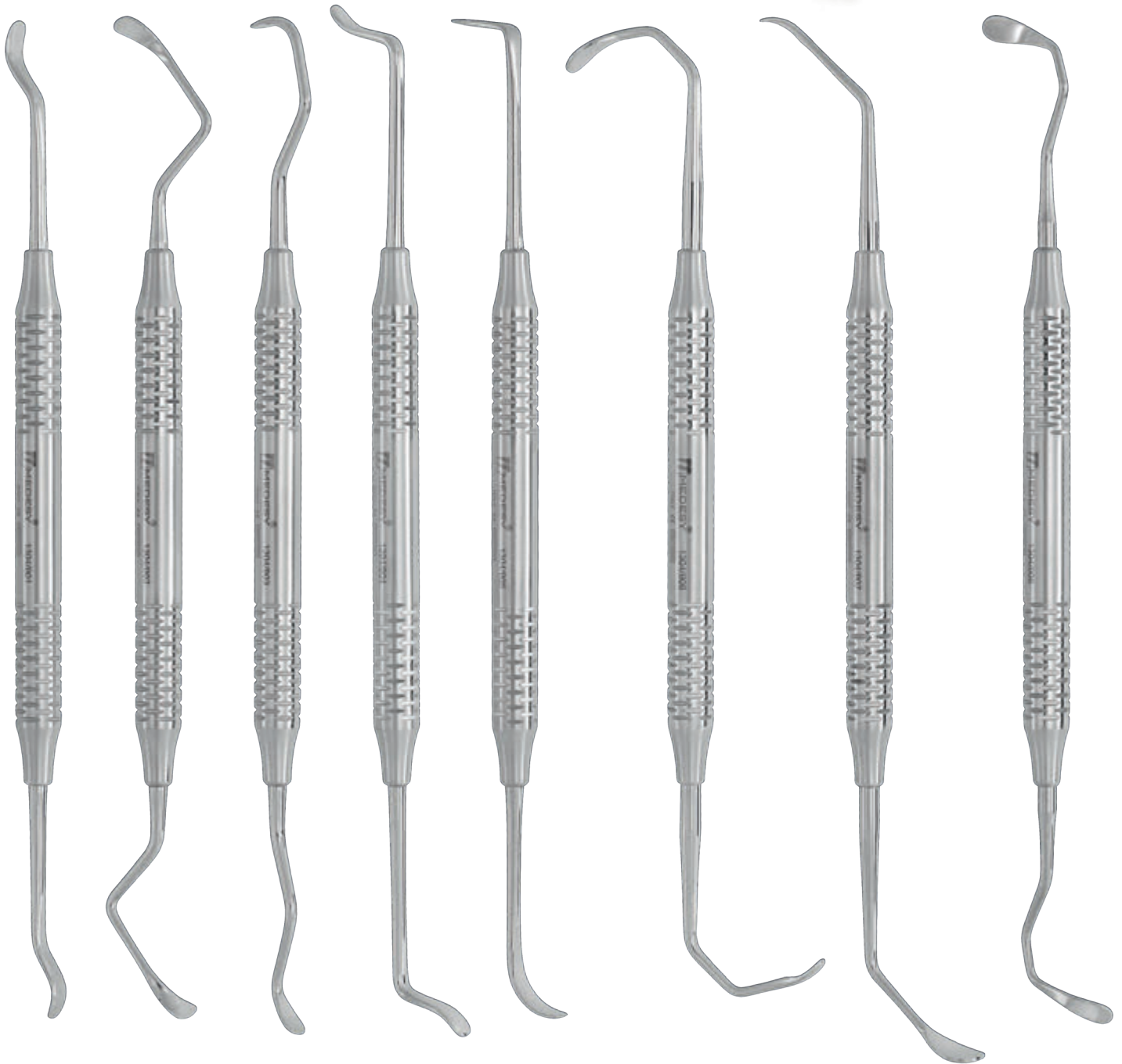

1304/901
N. 901

1304/902
N. 902

1304/903
N. 903

1304/904
N. 904

1304/905
N. 905

1304/906
Kramer-Nevis N. 906

1304/907
Kramer-Nevis N. 907

1304/908
N. 908

“ MEDESY IN SPOT

Sinus lift instruments are also available whit tips in titanium coated, Just add “TI” after the code.

Strumenti per il rialzo del seno mascellare sono disponibili nella versione in titanio, aggiungi “TI” dopo il codice. ”



(1:1 scale / scala 1:1)

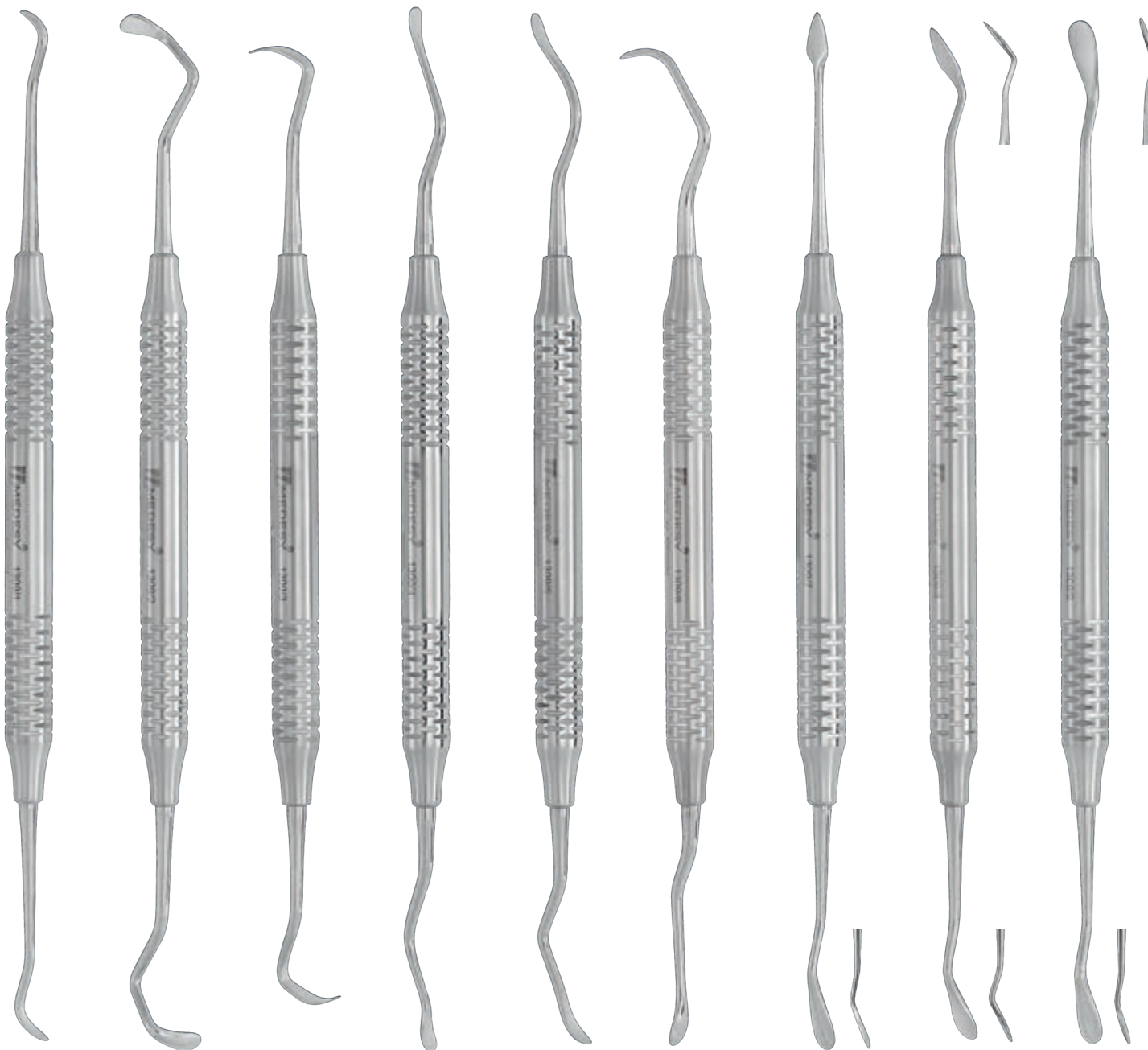

1309/1
N. 1

1309/2
N. 2

1309/3
N. 3

1309/4
N. 4

1309/5
N. 5

1309/6
N. 6

1309/7
Buser N. 7

1309/8
Buser N. 8

1309/9
Buser N. 9





mm 3,8



1340/1R (mm 170)
Straight
Retto

mm 3,8

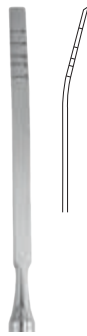

1340/2A (mm 170)
Curved
Curvo

mm 7,5



1340/3R (mm 170)
Straight
Retto

mm 7,5

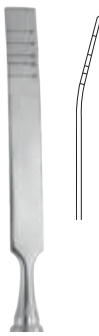

1340/4A (mm 170)
Curved
Curvo

mm 5



641/1 (mm 170)
Ochsenbein
Internal
Interno

mm 5



641/2 (mm 170)
Ochsenbein
External
Esterno

mm 3,9



941 (mm 170)
Wakefield 1W
Double cut
Taglio doppio

mm 4,9



942 (mm 170)
Wakefield 2W
Double cut
Taglio doppio





mm 3



1310/1S
mm 155

Single cut
Taglio singolo

mm 6



1310/2S
mm 155

Single cut
Taglio singolo

mm 9



1310/3S
mm 155

Single cut
Taglio singolo

mm 3



1310/4D
mm 155

Double cut
Taglio doppio

mm 6



1310/5D
mm 155

Double cut
Taglio doppio

mm 9



1310/6D
mm 155

Double cut
Taglio doppio

FLAT / PIATTO

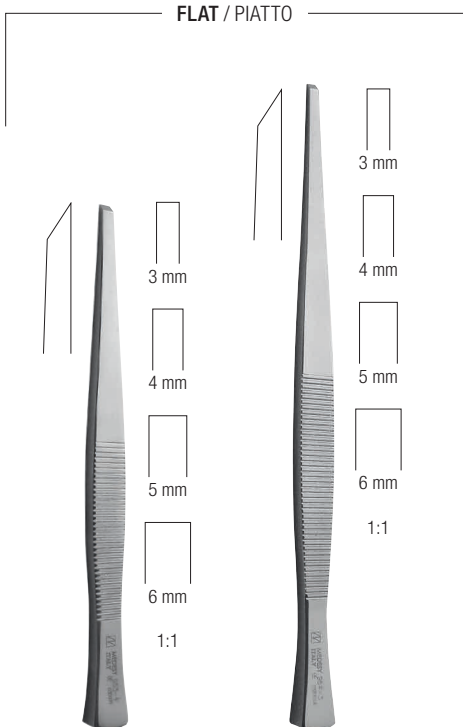

953/3 (mm 3)
953/4 (mm 4)
953/5 (mm 5)
953/6 (mm 6)
Partsch
mm 140

954/3 (mm 3)
954/4 (mm 4)
954/5 (mm 5)
954/6 (mm 6)
Partsch
mm 170

GROOVED / SCANALATO

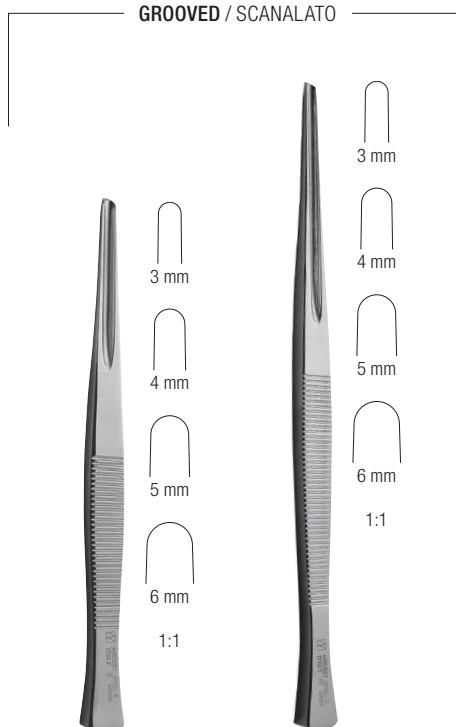

955/3 (mm 3)
955/4 (mm 4)
955/5 (mm 5)
955/6 (mm 6)
Partsch
mm 140

956/3 (mm 3)
956/4 (mm 4)
956/5 (mm 5)
956/6 (mm 6)
Partsch
mm 170



BONE SCRAPER GRATTINO PER OSSO



1325 (mm 155)

Straight
Retto

1325/LR

Spare part for 1325
Ricambio per 1325

Bone scraper essential instrument for collecting autogenous bone used for bone-regeneration. Its unique shape and sharp blade empower the collection of the cortical bone in the device's chamber. The graft is harvested with coagulated blood for easy and safe immediate implantation.

Grattino per osso, indispensabile strumento per utilizzare osso autologo. Grazie alla sua struttura permette di rimuovere l'osso per mezzo della lama affilata e raccoglierlo nell'apposito contenitore. L'utilizzo di osso autologo sarà poi immediato.



1325/A (mm150)

Curved
Curvo

1325/LRA

Spare part for 1325/A
Ricambio per 1325/A

1317/5.HL8
1317/5.HL10

Medesy BSP1
Bone scoop / plugger
Cucchiaio e compattatore



BONE MILL AND BONE CRUSHER PINZA MACINA OSSO E TRITURATORE



4895

Bone crusher for large bone pieces, inox
Trituratore per osso per porzioni grosse, inox
520 gr



4892 (mm 175)

Bone mill forceps
Pinza macina osso



Milling part in pure Titanium
(spare parts under request)
Macinatore in puro Titanio (parti di ricambio a richiesta)

BONE INJECTORS AND COLLECTORS

INIETTORI E CONTENITORI PER OSSO

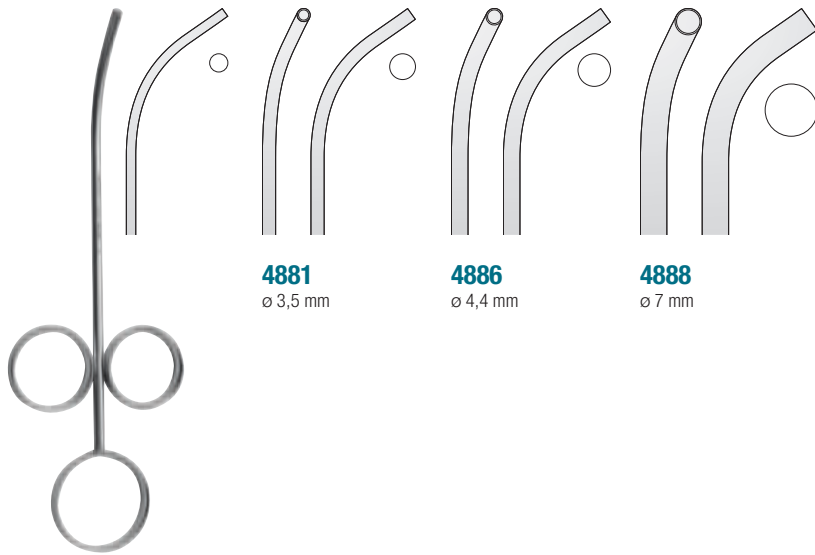

4881
ø 3,5 mm

4886
ø 4,4 mm

4888
ø 7 mm

4884 (mm 160)
ø 2,5 mm

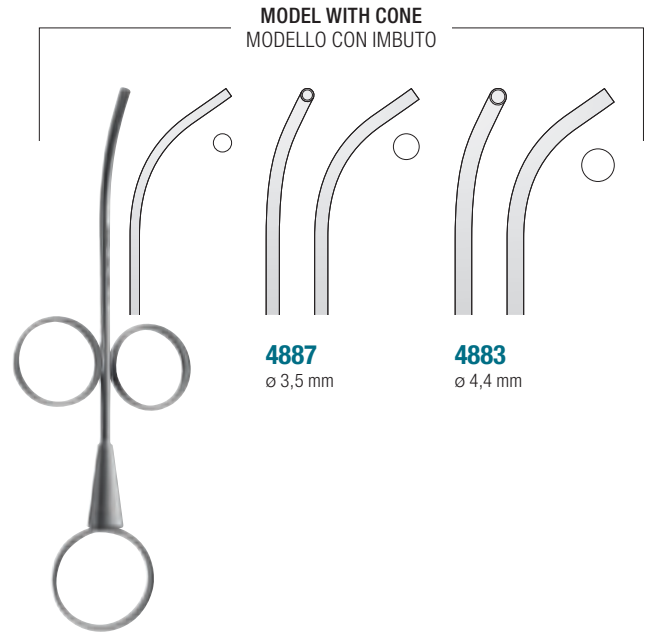

4887
ø 3,5 mm

4883
ø 4,4 mm

4882 (mm 160)
ø 2,5 mm



4885/BC (mm 155)
Medesy Bone Collector
Cucchiaio per osso Medesy



675/MBC (mm 180)
Mixing and Bone Collector spatula
Spatola per mescolare e raccogliere osso



4861/MOD (mm 155)
ø 3,5 mm
Bone injector
Iniettori d'osso



1162
60 × 50 × 15 mm
Mini tray titanium



ø 30 mm



h 25 mm

4854
Well in stainless steel
Mortajo in acciaio



BONE PLUGGERS COMPATTATORI PER OSSO



1317/1.HL8
1317/1.HL10

Medesy BP1

Bone pluggers
Compattatore per osso



1317/2.HL8
1317/2.HL10

Medesy BP2

Bone pluggers
Compattatore per osso

ø 3 mm



1306/8.HL8

Utility bone plugger/collector
Strumento per compattare/
raccogliere osso



1320/1

Bone compactor
Compattatore d'osso



1320/2

Bone compactor
Compattatore d'osso



1673/2

Kit bone management
Kit trattamento dell'osso

Content / Contenuto:

- 1162** Tray Titanium
- 1317/5** Bone scoop / plugger
- 1325/A** Bone scraper
- 1331/1** Surgical aspirator
- 1331/1F** Filter
- 4861/MOD** Bone injector ø 3,5 mm
- 4882** Bone injector ø 2,5 mm
- 980/9** Gammafis tray Doi

BONE ASPIRATORS

ASPIRATORI D'OSSO

ø mm 3,90



1331/1 (185 mm)
Bone aspirator ø 7 mm
Aspiratore d'osso ø 7 mm

1331/1F
Filter spare part ø 7 mm
Autoclavable
Autoclavabile

1331/2 (185 mm)
Bone aspirator ø 12 mm
Aspiratore d'osso ø 12 mm

1331/2F
Filter spare part ø 12 mm
Autoclavable
Autoclavabile

1330 (mm 270)
Bone aspirator ø 12 mm
Aspiratore d'osso ø 12 mm

1330/F
Inox autoclavable ø 12 mm
Inox autoclavabile ø 12 mm



1673/1

Kit aspiration
Kit aspiratori

Content / Contenuto:

- 1317/5 Bone scoop / plugger
- 1331/1 Surgical aspirator ø 7 mm
- 1331/1F Filter
- 1331/2 Surgical aspirator ø 12 mm
- 1331/2F Filter
- 978 Gammafix tray Un



TWEEZERS FOR PINS AND ABUTMENTS

PINZETTE PER PINS E ABUTMENTS



ø mm 1,8-2,0

Ti

1144/Ti (mm 155)

Pure titanium
Straight
Puro titanio
Retta

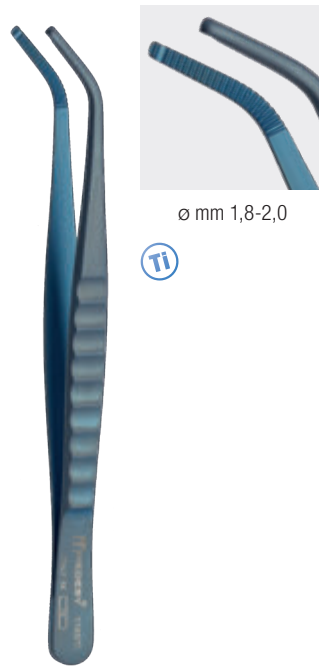

ø mm 1,8-2,0

Ti

1145/Ti (mm 150)

Pure titanium
Curved
Puro titanio
Curva



Ti

1128 (mm 160)

Pure titanium
With lock
Puro titanio
Con stop



1129 (mm 150)

Medesy
With lock
Con stop

MEMBRANE INSTRUMENTS

STRUMENTI PER MEMBRANE



mm 5 x 12

1112 (mm 120)

Straight
Retta



mm 5 x 12

1113 (mm 120)

Curved
Curva



1316/1.HL8

Membrane placer
Strumento per posizionare membrane

(1:1 scale / scala 1:1)

(1:1 scale / scala 1:1)



1140 (mm 150)
Micro tweezer titanium
Straight
Micro pinzetta titanium
Retta



1141 (mm 150)
Micro tweezer titanium
Curved
Micro pinzetta titanium
Curva

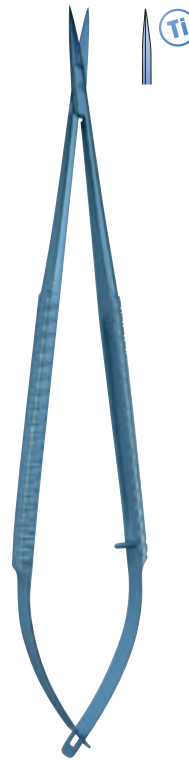
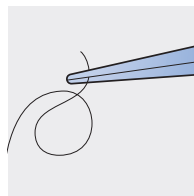

1970 (mm 180)
Micro scissors titanium
Straight
Micro forbici titanium
Retta

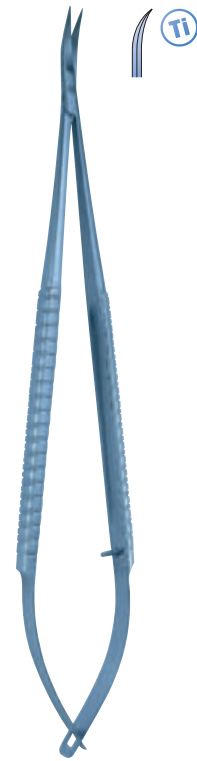

1971 (mm 180)
Micro scissors titanium
Curved
Micro forbici titanium
Curva



2010 (mm 180)
Micro needleholder titanium
Straight
Micro porta-aghi titanium
Retta

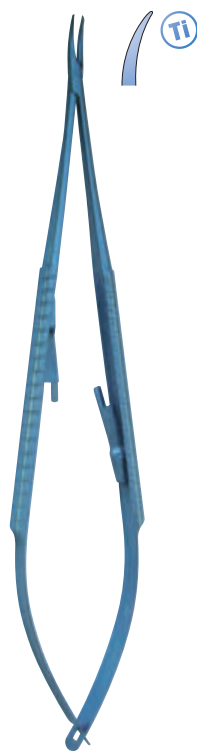

2012 (mm 180)
Micro needleholder titanium
Curved
Micro porta-aghi titanium
Curva

(1:1 scale / scala 1:1)

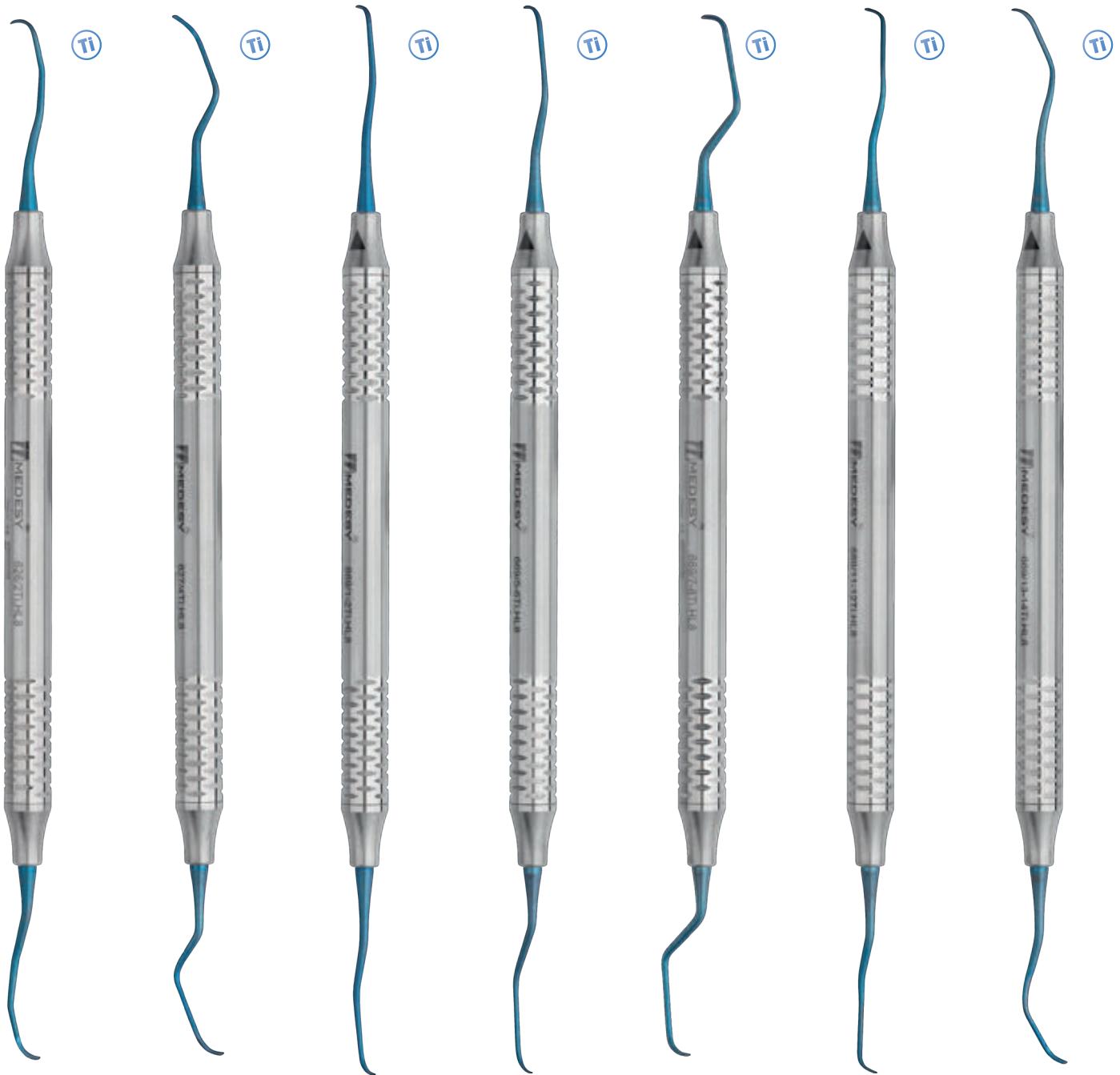

626/2Ti.HL8
626/2Ti.HL10
Columbia 4R/4L

Titanium
Titanio

627/4Ti.HL8
627/4Ti.HL10
Columbia 4R/4L

Titanium
Titanio

669/1-2Ti.HL8
669/1-2Ti.HL10
Gracey Short type

Titanium
Titanio

669/5-6Ti.HL8
669/5-6Ti.HL10
Gracey Short type

Titanium
Titanio

669/7-8Ti.HL8
669/7-8Ti.HL10
Gracey Short type

Titanium
Titanio

669/11-12Ti.HL8
669/11-12Ti.HL10
Gracey Short type

Titanium
Titanio

669/13-14Ti.HL8
669/13-14Ti.HL10
Gracey Short type

Titanium
Titanio

1671/3

Perimplantite Kit
Kit Perimplantite

Content / Contenuto:

548/4 PT	Probe CP15
627/4Ti.HL8	Curette Columbia 4R/4L Titanium
651/11Ti.HL8	Scaler H6-H7 Titanium
669/5-6Ti.HL10	Gracey short type Titanium
669/7-8Ti.HL10	Gracey short type Titanium
669/11-12Ti.HL10	Gracey short type Titanium
669/13-14Ti.HL10	Gracey short type Titanium
980/9	Gammafix tray Doi

(1:1 scale / scala 1:1)



640/1Ti.HL8
640/1Ti.HL10

Scaler 204 S

Titanium
Titanio

640/5Ti.HL8
640/5Ti.HL10

Scaler 204 SD

Titanium
Titanio

651/11Ti.HL8
651/11Ti.HL10

Hygienist H6/H7

Titanium
Titanio



KIT PERIMPLANTITE

The bacterial aggression observed on the neck portion of the implants is similar to the bacterial aggression observable at the muco-gingival junction of the tooth. The stainless steel instruments may contaminate the titanium made implants while plastic instruments do not fully remove the failing tissues around the implant. Hence the need of using instruments made of titanium, the unique solution for a real efficient and fully safe handling on and close to the implants sites. Blue colour for a simple and fast identification of titanium tips, from standard gray of stainless steel. **MEDESY Perimplantite kit includes 4 curettes "Short Type"; 1 curette Columbia; 2 Scalers; 1 periodontal probe.**

L'aggressione batterica osservata nel collo degli impianti è simile a quella presente a livello della giunzione muco gengivale del dente. Gli strumenti in acciaio possono contaminare il titanio degli impianti, mentre quelli in plastica non sono in grado di rimuovere in modo efficiente la parte in oggetto. Da qui la necessità di usare strumenti in titanio, la soluzione sicuramente più adeguata per una gestione del problema efficiente ed in piena sicurezza in prossimità degli impianti. Il colore blu delle punte, serve per identificare in modo semplice e sicuro il titanio impiegato, rispetto al tradizionale acciaio.

Il kit Perimplantite di MEDESY è composto da: 4 curettes "Tipo Corto"; 1 curette Columbia; 2 scaler; 1 sonda parodontale.



(1:1 scale / scala 1:1)



Code	ø int.	ø ext.
1318/2,3	2,3 mm	2,9 mm
1318/3,5	3,5 mm	4,3 mm
1318/4,1	4,1 mm	4,8 mm
1318/4,6	4,6 mm	5,4 mm
1318/5,1	5,1 mm	5,9 mm

1318/4,1

Circular mucotome to remove gum and uncover implants in order to insert the healing screw.
Mucotomo circolare per la rimozione della gengiva e scopertura degli impianti per l'inserimento della vite di guarigione.

Dental TREPHINES: facilitate the removal of sections of bone thanks to a specific very thin circular saw-like edge and precise laser printed depth markings (*Trephines code nr.1315/xx and mucotomes code nr.1318/xx are in Class IIa*).

(1:1 scale / scala 1:1)

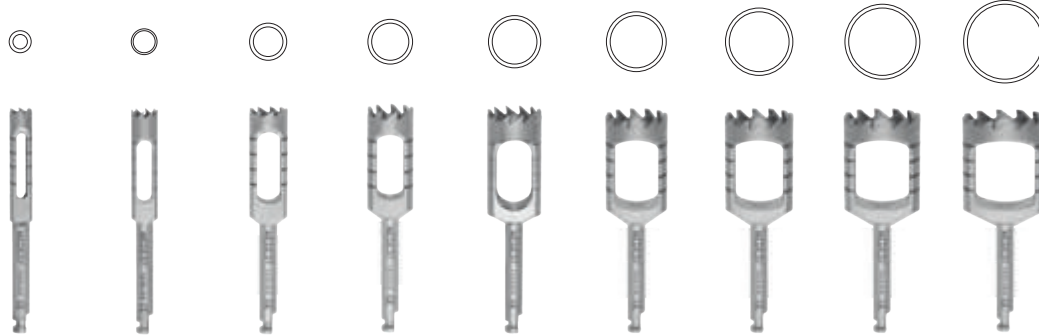

1315/2,0 1315/3,0 1315/4,0 1315/5,0 1315/6,0 1315/7,0 1315/8,0 1315/9,0 1315/10,0



Manual tissue punches
Punzone per tessuti
manuale

1319/4R (ø 4 mm)

1319/5R (ø 5 mm)

1319/6R (ø 6 mm)

Keys (mm 100)

Straight

Retto

1319/4C (ø 4 mm)

1319/5C (ø 5 mm)

1319/6C (ø 6 mm)

Keys (mm 80)

Curved 90°

Curvo 90°

Frese carotatrici per osso TREPHINE: agevolano il prelievo osseo grazie alla particolare dentatura e tacche di profondità marcate al laser (*Le frese Trephine cod. 1315/xx ed i mucotomi cod. 1318/xx sono in Classe IIa*).

Code	ø int.	ø ext.
1315/2,0	2,0 mm	3,0 mm
1315/2,5	2,5 mm	3,5 mm
1315/3,0	3,0 mm	3,5 mm
1315/3,5	3,5 mm	4,5 mm
1315/4,0	4,0 mm	5,0 mm
1315/4,5	4,5 mm	5,5 mm
1315/5,0	5,0 mm	6,0 mm
1315/5,5	5,5 mm	6,5 mm
1315/6,0	6,0 mm	7,0 mm
1315/6,5	6,5 mm	7,5 mm
1315/7,0	7,0 mm	8,0 mm
1315/7,5	7,5 mm	8,5 mm
1315/8,0	8,0 mm	9,0 mm
1315/8,5	8,5 mm	9,5 mm
1315/9,0	9,0 mm	10,0 mm
1315/9,5	9,5 mm	10,5 mm
1315/10,0	10,0 mm	11,0 mm



957/2

Plastic autoclavable
up to 134°
Contains 15 pcs

Plastica autoclavabile
fino a 134°
Contiene 15 pezzi



957/1

Drill case – Inox

6 pcs
6 pezzi

(2:1 scale / scala 2:1)

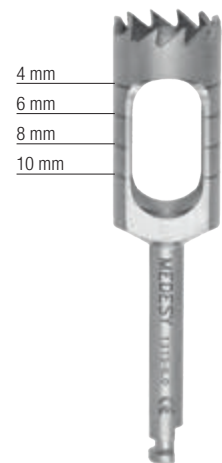

4 mm
6 mm
8 mm
10 mm



4578 (145 mm)



4580 (155 mm)
Medesy



4987/1R (Straight / Retto)
4987/2A (Curved / Curvo)
Castroviejo (mm 85)



4995/1R (Straight / Retto)
4995/2A (Curved / Curvo)
Castroviejo (mm 170)

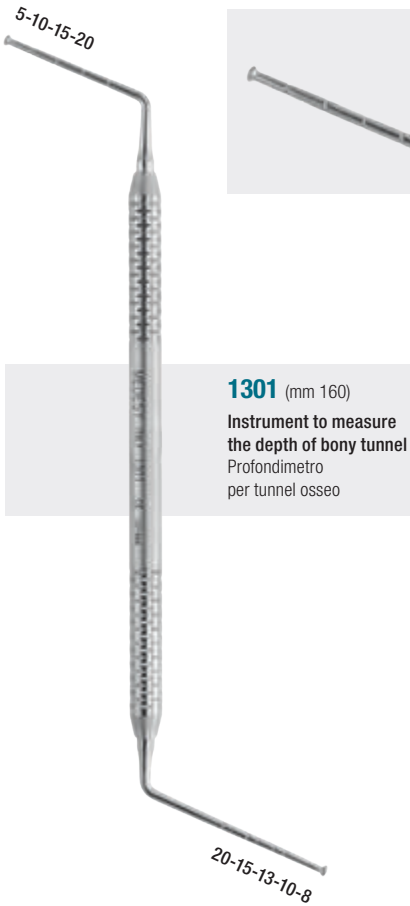

1301 (mm 160)
Instrument to measure
the depth of bony tunnel
Profondimetro
per tunnel osseo



4989 (mm 125)
Caliper round
Calibro tondo

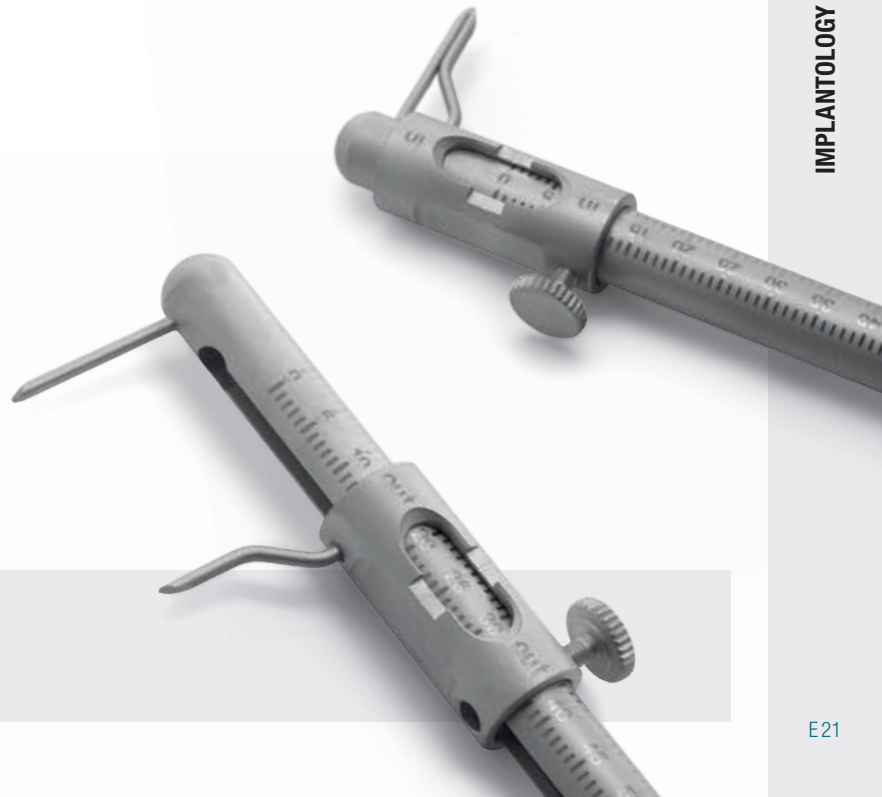

BONE GRAFT HOLDING PLIERS

PINZE TRATTIENI OSSO



1540 (mm 220)
Arnhold
Straight
Retta

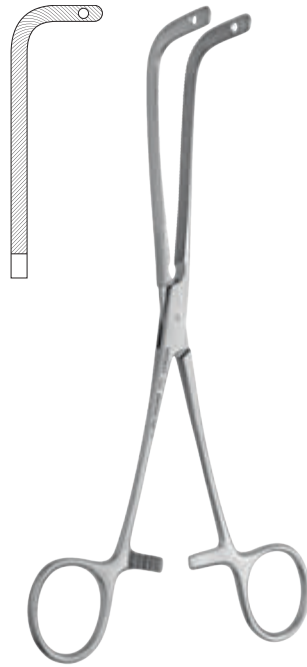

1541 (mm 220)
Arnhold
Curved
Curva



1542 (mm 200)
Arnhold
Curved
Curva



For placing screws on bone blocks
Per fissare viti in blocchetti d'osso

CRANIO-FACIAL FORCEPS

PINZE CRANIO-FACCIALI



1545 (mm 225)
Rowe
Left
Sinistro



1546 (mm 225)
Rowe
Right
Destro

1350/KIT

Kit bone splitting
Kit per osso

Content / Contenuto:

1304/901	Sinus lift n.901
1304/902	Sinus lift n.902
1304/905-Ti	Sinus lift n.905 Titanium
1310/1S	Chisel 3 mm
1310/2S	Chisel 6 mm
1310/3S	Chisel 9 mm
3809	Bone rongeur Micro Friedman
941	Chisel Wakefield 1W
942	Chisel Wakefield 2W
952/25	Hammer Medesy
981/19	Gammatrix tray Quatri

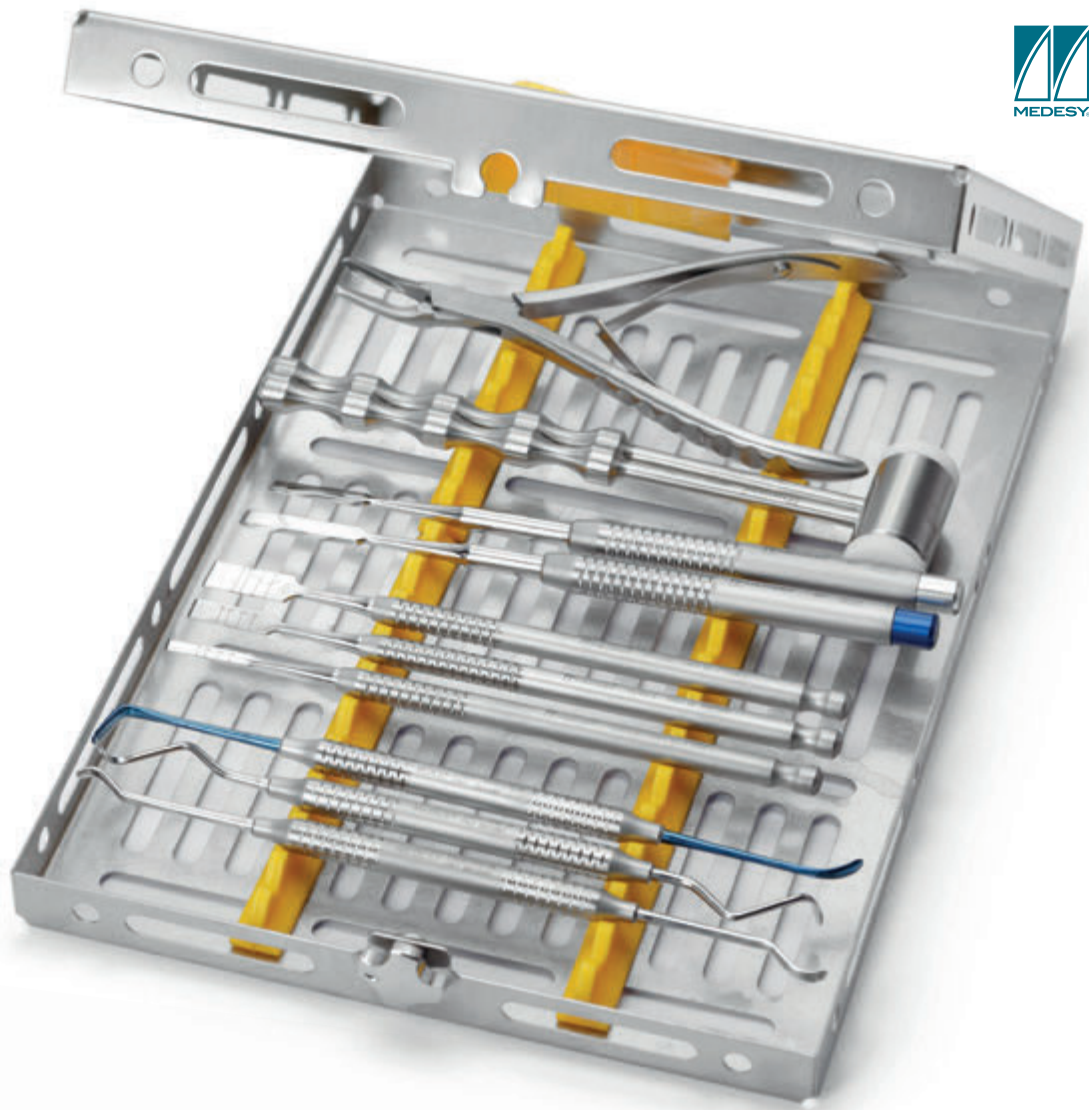

1955/KIT

Kit bone split and sinus lift
Kit per osso e rialzo del seno mascellare

Content / Contenuto:

1304/902	Sinus lift n.902
1304/905	Sinus lift n.905
1309/7	Sinus lift n.7
1310/5D	Chisel 6 mm
1310/6D	Chisel 9 mm
1340/1R	Chisel 1R
1340/2A	Chisel 2A
1340/3R	Chisel 3R
1340/4A	Chisel 4A
980/10	Gammatrix tray Tre



1673/5

Kit osteotomes & sinus elevation

Kit osteotomi e rialzo del seno mascellare

Content / Contenuto:

1322/1	Osteotome concave ø 2,7 mm
1322/2	Osteotome concave ø 3,2 mm
1322/3	Osteotome concave ø 3,7 mm
1322/4	Osteotome concave ø 4,2 mm
1322/5	Osteotome concave ø 5,0 mm
1322/6	Osteotome concave ø 2,7 mm bayonet
1322/7	Osteotome concave ø 3,2 mm bayonet
1322/8	Osteotome concave ø 3,7 mm bayonet
1322/9	Osteotome concave ø 4,2 mm bayonet
1322/10	Osteotome concave ø 5,0 mm bayonet
4883	Bone injector ø 4,4 mm
4887	Bone injector ø 3,5 mm
952/25	Hammer Medesy ø 25 mm
981/19	Gammatrix tray Quatri



1673/7

Kit sinus advanced

Kit sinus advanced

Content / Contenuto:

1309/1	Sinus lift n.1
1309/2	Sinus lift n.2
1309/7	Sinus lift n.7
1321/2	Osteotome convex ø 3,2 mm
1321/3	Osteotome convex ø 3,7 mm
1321/7	Osteotome convex ø 3,2 mm bayonet
1321/8	Osteotome convex ø 3,7 mm bayonet
1322/2	Osteotome concave ø 3,2 mm
1322/3	Osteotome concave ø 3,7 mm
1322/7	Osteotome concave ø 3,2 mm bayonet
1322/8	Osteotome concave ø 3,7 mm bayonet
661/85.HL8	Bone curette Lucas n.85
661/86.HL8	Bone curette Lucas n.86
661/87.HL8	Bone curette Lucas n.87
952/25	Hammer Medesy ø 25 mm
981/19	Gammatrix tray Quatri

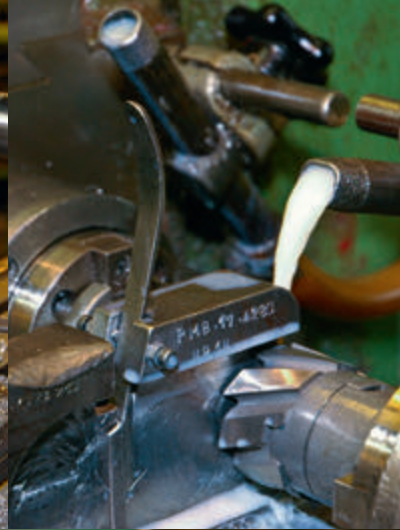
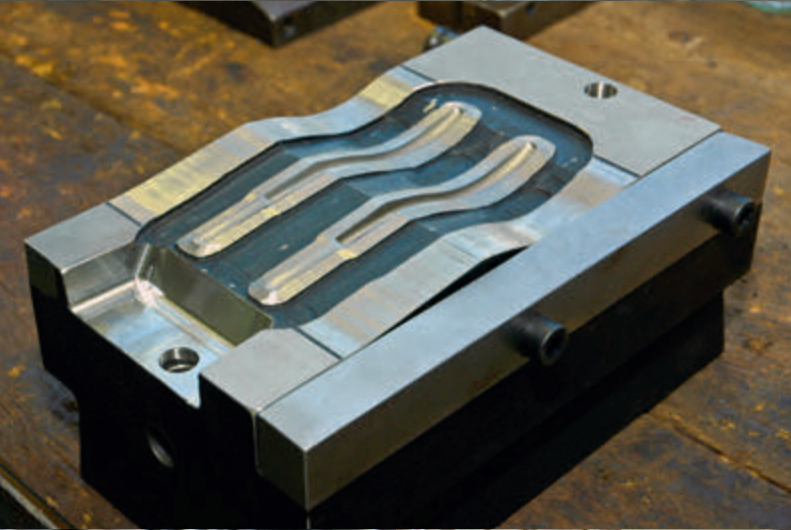

ORTHODONTICS / ORTODONZIA

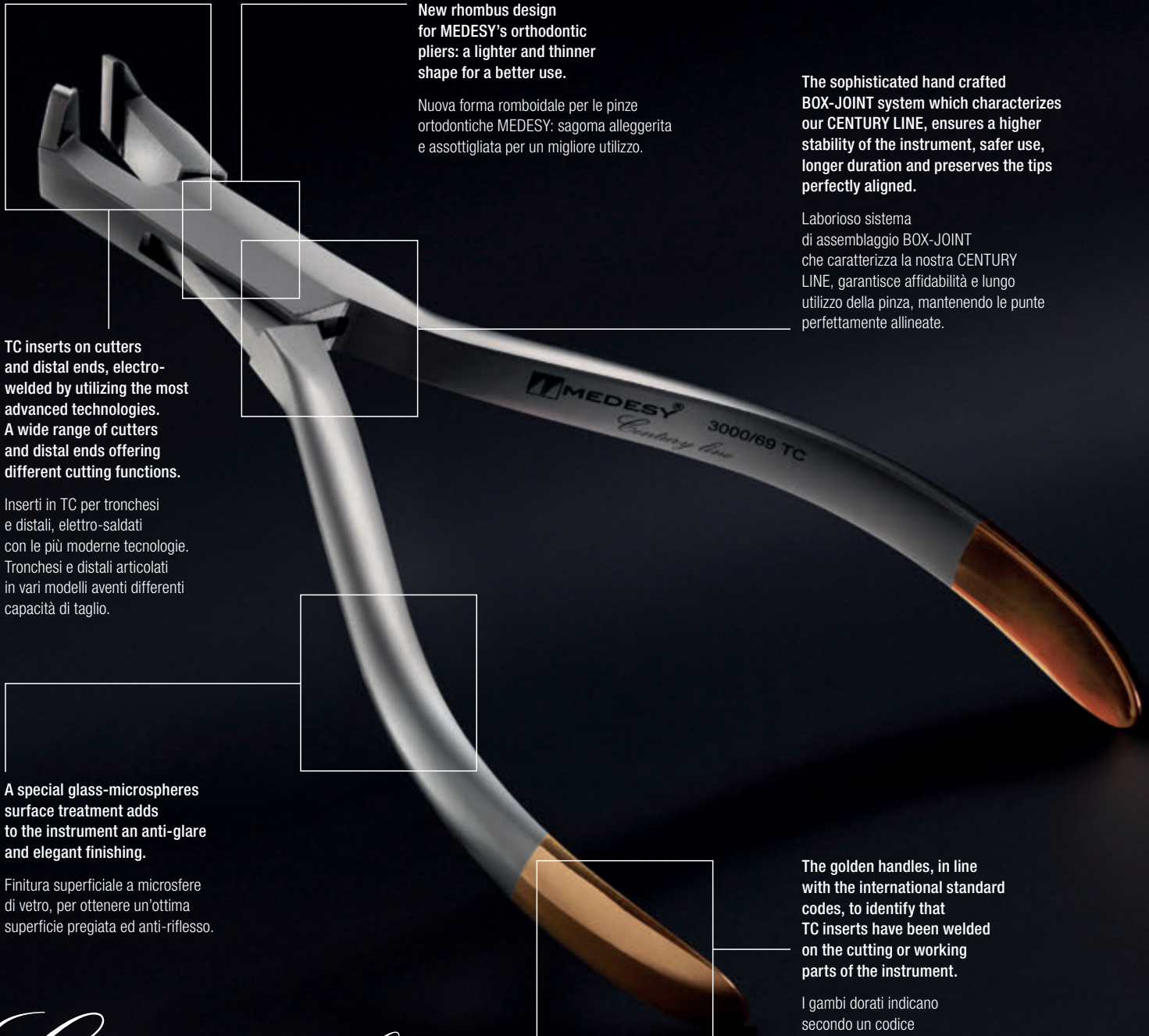

New rhombus design for MEDESYS's orthodontic pliers: a lighter and thinner shape for a better use.

Nuova forma romboidale per le pinze ortodontiche MEDESYS: sagoma alleggerita e assottigliata per un migliore utilizzo.

The sophisticated hand crafted BOX-JOINT system which characterizes our CENTURY LINE, ensures a higher stability of the instrument, safer use, longer duration and preserves the tips perfectly aligned.

Laborioso sistema di assemblaggio BOX-JOINT che caratterizza la nostra CENTURY LINE, garantisce affidabilità e lungo utilizzo della pinza, mantenendo le punte perfettamente allineate.

TC inserts on cutters and distal ends, electro-welded by utilizing the most advanced technologies. A wide range of cutters and distal ends offering different cutting functions.

Inserti in TC per tronchesi e distali, elettro-saldati con le più moderne tecnologie. Tronchesi e distali articolati in vari modelli aventi differenti capacità di taglio.

A special glass-microspheres surface treatment adds to the instrument an anti-glare and elegant finishing.

Finitura superficiale a microsferi di vetro, per ottenere un'ottima superficie pregiata ed anti-riflesso.

The golden handles, in line with the international standard codes, to identify that TC inserts have been welded on the cutting or working parts of the instrument.

I gambi dorati indicano secondo un codice internazionale l'inserimento di placche in TC nella parte lavorante o tagliente.

Century line

SPECIFICATIONS ON THE CODES SPECIFICHE SUI CODICI

Code Codice	3000/74 TC
Type Modello	Flush slim
Thickness of wire Spessore del filo	ø max 0,41 × 0,55 mm / .016" × .021"
Length of the instrument Lunghezza dello strumento	(mm 125)



Yellow color for TC instruments
Colore giallo per strumenti in TC

Grey color for standard instruments
Colore grigio per strumenti tradizionali

DISTAL END CUTTERS

TRONCHESINI DISTALI CON RITENUTA



3000/69 TC
(1:1 scale / scala 1:1)



3000/69 TC

ø max 0,55 × 0,64 mm / .021" × .025"
(mm 125)

This cutter cuts and holds the portion of wire in excess. Developed for stainless steel and NiTi wires.

3000/69 TC LL

ø max 0,55 × 0,64 mm / .021" × .025"
(mm 150)

Same as 3000/69 TC but with long handle.



3000/74 TC

Flush slim
ø max 0,41 × 0,55 mm / .016" × .021"
(mm 125)

This cutter cuts and holds wire distally flush to the buccal tube.

3000/76 TC

Flush
ø max 0,55 × 0,64 mm / .021" × .025"
(mm 125)

Same as 3000/74 TC but with regular head.



PIN AND LIGATURE CUTTERS

3000/89 TC
(1:1 scale / scala 1:1)

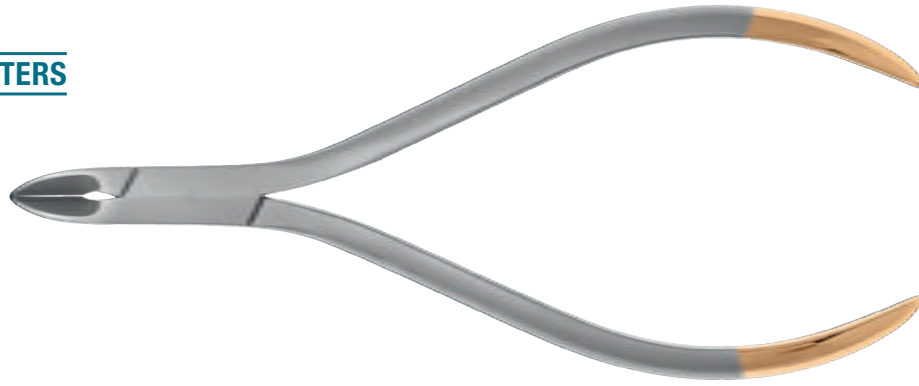

TC



3000/89 TC

∅ max 0,3 mm / .012"
(mm 120)

Delicate cutter, specially designed for the removal of soft stainless steel ligatures.



TC

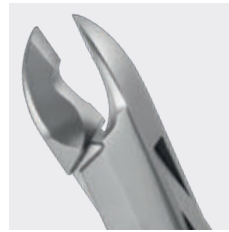

3000/91 TC

∅ max 0,3 mm / .012"
(mm 125)

Delicate cutter with a fine tip for easier access to difficult areas. Cut elastics, ligatures, pins and wire.



TC



3000/99 TC

∅ max 0,4 mm / .016"
(mm 130)

Medium cutter ensuring accurate and precision cutting of elastics, ligatures, pins and wire.



TC



3000/85 TC

∅ max 0,3 mm / .012"
(mm 130)

Standard cutter with slim profile, allowing an easy access and better view of the oral cavity.



15°

TC

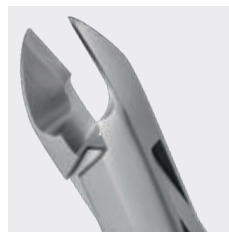

3000/85 TC 15°

∅ max 0,3 mm / .012"
(mm 130)

Angled 15°

Same as 85TC, but with a 15° offset tip enhancing a better access in difficult areas

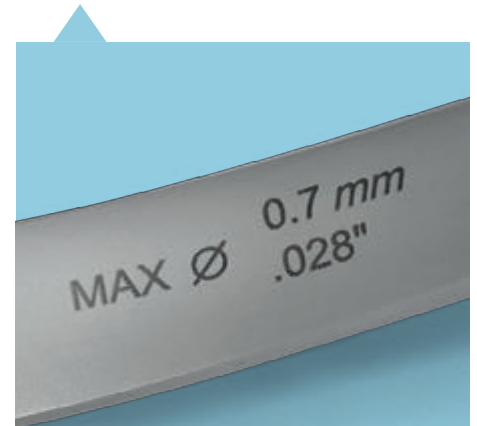

“
MEDESYS IN SPOT
The orthodontic pliers are laser engraved with the maximum cut capacity (for cutters only) or applicable wire, in millimeters and inches.

Le pinze ortodontiche riportano la capacità massima di taglio (per i tronchesini) o il diametro massimo consentito, in millimetri e inches.
”

HARD WIRE CUTTERS



3000/87 TC

(1:1 scale / scala 1:1)

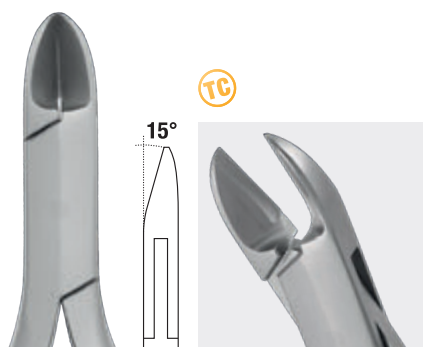

3000/94 TC

ø max 0,4 mm / .016"
(mm 130)

Angled 15°

Medium cutter with rounded and slim tip. 15° offset tips help in posterior area.



3000/87 TC

ø max 0,7 mm / .028"
(mm 130)

Suitable for cutting archwires or pins of any size. TC inserts ensuring longer duration.

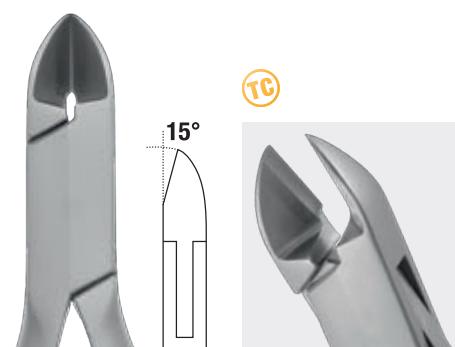

3000/87 TC 15°

ø max 0,7 mm / .028"
(mm 130)

Angled 15°

Same as 87TC, but with a 15° offset tip enhancing a better access in difficult areas



3000/92 TC

ø max 1,0 mm / .040"
(mm 140)

For front cutting of heavy wires.



3000/18 TC

ø max 1,0 mm / .040"
(mm 155)

For an easy cutting of any size of archwire or pin. 15° offset tips for an easier access to the posterior area.



9952/160 TC

ø max 1,5 mm / .060"
(mm 170)

Double action system for heavy wires, reduce effort on cutting.



3000/31

(1:1 scale / scala 1:1)

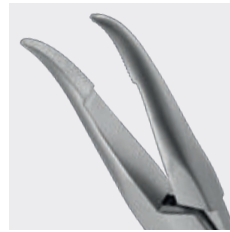

3000/31

Weingart
ø max 0,7 mm / .028"
(mm 145)

Versatile utility plier with very fine serration.

3000/32

Weingart – Slim
ø max 0,5 mm / .020"
(mm 145)

Weingart with fine points.

3000/25 TC

Weingart angled
ø max 0,5 mm / .020"
(mm 140)

Weingart with TC tips, indicated also for placement and removal of archwires, because of the tapered angular design.

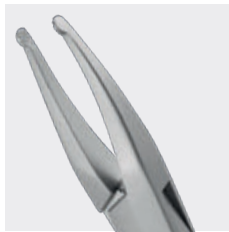

3000/84

How plier – Straight
ø max 0,7 mm / .028"
(mm 140)

Utility plier with round and serrated tips. Ideal for removal and placement of the archwires. Grasping all types of auxiliaries attachments.

3000/72

How plier – Angled
ø max 0,7 mm / .028"
(mm 140)

45° angled tips for convenient access to lingual and others difficult posteriors areas.

WIRE BENDING PLIERS

PINZE PIEGA FILI



3000/39 TC
(1:1 scale / scala 1:1)

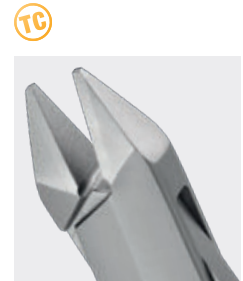
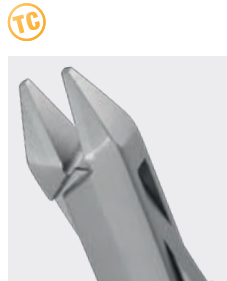

3000/23
Adams
ø max 0,7 mm / .028"
(mm 125)

Squared beaks, clasp and wire bending plier.

3000/23 TC
Adams
ø max 0,7 mm / .028"
(mm 125)

Squared beaks, clasp and wire bending plier, TC inserts.

3000/47 TC
N.64
ø max 1,0 mm / .040"
(mm 140)

Squared beaks, heavy type, TC inserts.

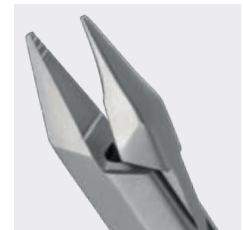
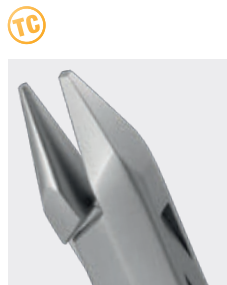
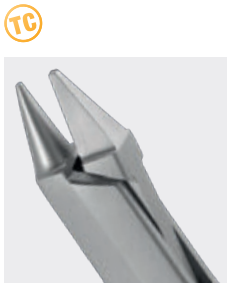

3000/39 TC
Angle N.139
ø max 0,7 mm / .028"
(mm 125)

Bird beak plier, cone and pyramidal tips in TC. Indicated for loops and general bending of round wires.

3000/86 TC
Angle N.138
ø max 1,0 mm / .040"
(mm 130)

Long bird beaks for heavy wire. TC inserts.

3000/21
ø max 0,7 mm / .028"
(mm 130)

4 grooved bird beaks used to form precise loops in round, squared or rectangular light wire.



ORTHODONTICS / ORTODONZIA

3000/54

(1:1 scale / scala 1:1)



TC



3000/40C TC

Tweed
 ø max 0,4 mm / .016"
 (mm 130)

With cutter

Ideal with round and square wire, for making consistent uniform loops. Section tips 1,2-1,8-2,0 mm.

TC



3000/38C TC

ø max 0,6 mm / .024"
 (mm 135)

With cutter

Light wire cutting and contouring plier. For round wire, to bend small ø loops. Contouring of loops and arches up to 0,55 x 0,64 mm.

“ MEDESYS IN SPOT

Conversion chart

Scala di conversione

mm	Inch
0,3	0,012"
0,4	0,016"
0,5	0,020"
0,6	0,024"
0,7	0,028"
0,8	0,031"
0,9	0,035"
1,0	0,040"

”

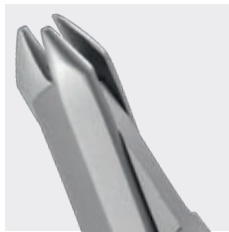

3000/57

Aderer – Short
 ø max 0,6 mm / .024"
 (mm 120)

3 jaw plier – Short. Slightly rounded tips, for contouring and bending without damaging the archwire.

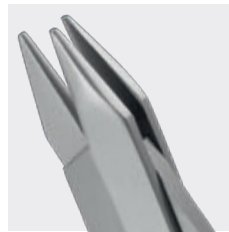

3000/54

Aderer – Long
 ø max 0,7 mm / .028"
 (mm 130)

3 jaw plier – Long. Slightly rounded tips, for contouring and bending without damaging the archwire.



3000/20

Jarabak
 ø max 0,7 mm / .028"
 (mm 140)

Light wire bending plier. Versatile in different uses, as bending or closing loops. One beak partially serrated for safe grip.

3000/51
(1:1 scale / scala 1:1)

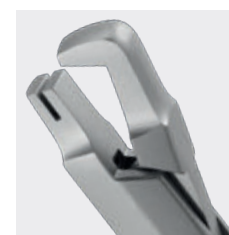

3000/51

Tweed – Short
ø max 0,5 mm / .020"
(mm 125)

*Arch forming plier – Short.
Ideal for torquing and bending
squared or rectangular wire.
Parallel blades prevents
crushing of wires.*

3000/52

Tweed – Long
ø max 0,7 mm / .028"
(mm 130)

*Arch forming plier – Long.
As 3000/51 but for bigger wires size.*

3000/30

Schwarz
ø max 0,7 mm / .028"
(mm 130)

Arrow clasp bending plier.



3000/34

De La Rosa
ø max 0,5 mm / .020"
(mm 125)

*Contours and forms archwires,
of light wire without torquing.*

3000/35

De La Rosa
ø max 0,5 mm / .020"
(mm 125)

*Same as 3000/34 with additional
grooves measuring respectively
0,41-0,46-0,56 mm.*

3000/58

ø max 0,7 mm / .028"
(mm 125)

*Lingual arch forming plier for
fast forming all lingual retainers.*



3000/98

(1:1 scale / scala 1:1)

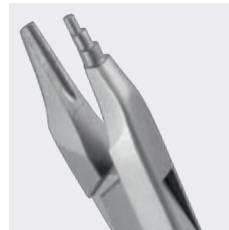

3000/98

Tweed – Short
 ø max 0,5 mm / .020"
 (mm 135)

Designed to form precise omega loops. Long grooved beak internally smoothed. Short type.

3000/95

Tweed – Short
 ø max 0,5 mm / .020"
 (mm 135)

Designed to form precise omega loops. Short grooved beak internally serrated. Short type.

3000/55

Young – Short
 ø max 0,7 mm / .028"
 (mm 130)

Ideal for labial arches and face bow. Universal plier for different size loops.



3000/96

Tweed – Long
 ø max 0,5 mm / .020"
 (mm 145)

Designed to form precise omega loops. Long grooved beak internally smoothed. Long type.

3000/97

Tweed – O'Brein
 ø max 0,7 mm / .028"
 (mm 140)

Graduated cone to form precise omega and closing loops. Micro serrated beaks to prevent wire slippage.

3000/81
(1:1 scale / scala 1:1)



3000/53

Optical
⌀ max 0,7 mm / .028"
(mm 140)

Concave/convex loop forming plier, small-medium.

3000/79

Optical
⌀ max 0,7 mm / .028"
(mm 135)

Concave/convex loop forming plier, medium-large.

3000/70

Hollow chop
⌀ max 0,7 mm / .028"
(mm 140)

Contours and form arches of all sizes.

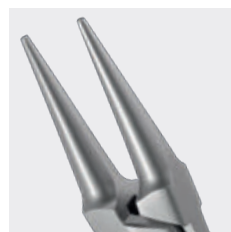
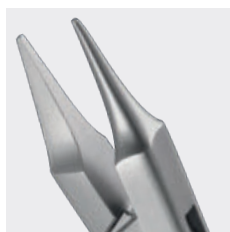

3000/81

Long and delicate beaks plier.

⌀ max 0,5 mm / .020"
(mm 135)

3000/28

2 round beaks long.

⌀ max 0,5 mm / .020"
(mm 140)

MEDESY IN SPOT

The new lubricant oil for orthodontic instruments. If used regularly it ensures a long product lifespan and optimal performances: facilitates the smooth and perfect function for all hinged instruments and helps to prevent freezing from corrosion and sediments.

Nuovo olio lubrificante per pinze ortodontiche. Se usato regolarmente prolunga la durata e l'efficienza dello strumento: l'olio favorisce il movimento scorrevole e delicato degli strumenti a snodo, proteggendo al tempo stesso da corrosione e sedimenti.

4160
12 ml
Tip length 40 mm
Lunghezza punta 40 mm



4155
12 ml
Tip length 7 mm
Lunghezza punta 7 mm



3000/63

(1:1 scale / scala 1:1)

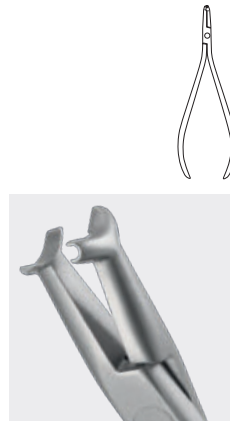
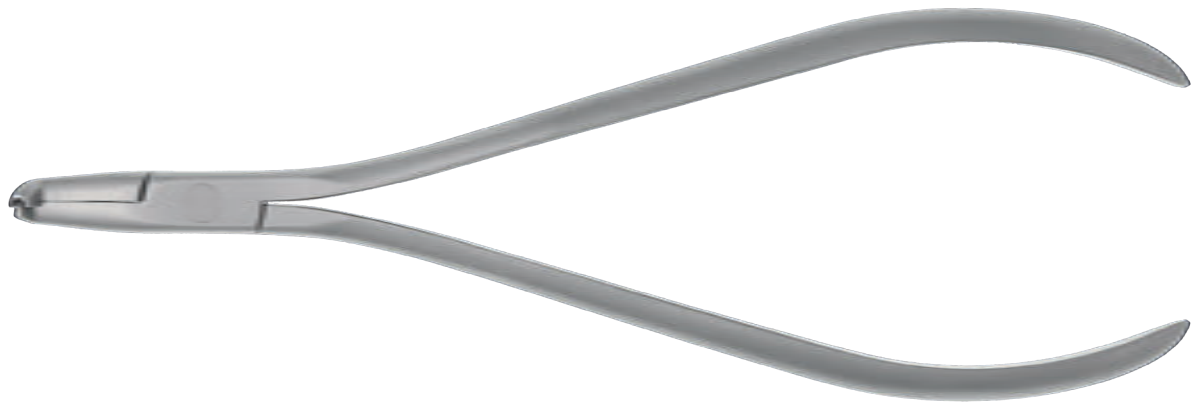

3000/80

Nance
 ø max 0,7 mm / .028"
 (mm 125)

*Loop bending plier.
 Four step tips (3, 4, 5, 6 mm)
 for loops forming.
 Round and rectangular wire.*

3000/63

Cinch back
 ø max 0,55 x 0,64 mm
 ø max .021" x .025"
 (mm 155)

*Cinch back utility plier.
 For closing arches or cinch down a wire.
 Use on round or rectangular wire.*



3000/43

ø max 0,5 mm / .020"
 (mm 140)

*Closing loop plier.
 Different loops in only one plier.*

3000/60

ø max 1,4 mm / .055"
 (mm 130)

*3 prong plier. For hard wires.
 Round tips prevents any
 damage of archwire.*

3000/56

Nance
 ø max 0,7 mm / .028"
 (mm 135)

*Loop closing plier.
 For bending of stop loops and
 ideal for Adams clasps.*

3000/61
(1:1 scale / scala 1:1)

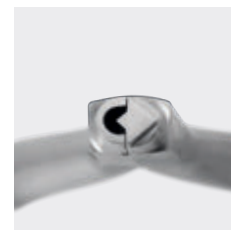
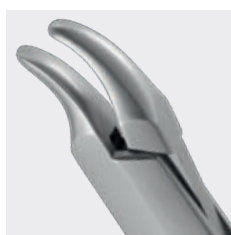
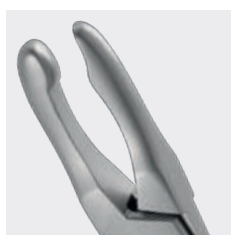

3000/59

Johnson
ø max 0,7 mm / .028"
(mm 135)

Crown and band contouring plier.

3000/61

Reynolds
ø max 0,7 mm / .028"
(mm 130)

Crown and band contouring plier.

3000/29

Schwarz
ø max 0,7 mm / .028"
(mm 125)

Arrow clasp bending plier.

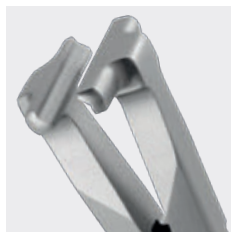

3000/15

Step plier
ø max 0,55 × 0,64 mm
ø max .021" × .025"
(mm 140)

Double side head to create steps in archwire.

3000/171

V-Stop
ø max 0,55 × 0,64 mm
ø max .021" × .025"
(mm 130)

For bending archwire in V-form, in order to avoid any movement.



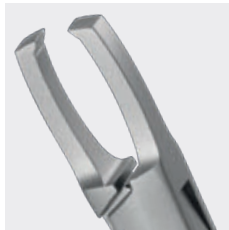
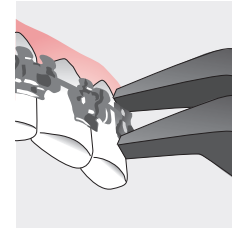

Pliers to remove the brackets: the extremely sharp tips allow an easy access under the flange of the bracket and facilitate its detachment.

Pinze per rimozione attacchi: le punte affilate permettono di entrare sotto la flangia dell'attacco e ne consentono il distacco con estrema facilità.

3000/83

Bracket remover – Straight
(mm 135)

3000/82

Bracket remover – Angled
(mm 130)

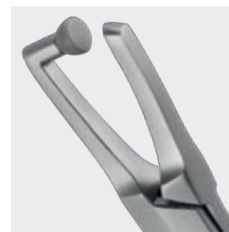
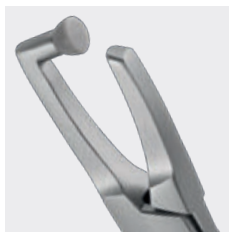
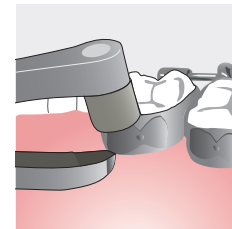

Pliers to remove the bands available in two sizes, short and long. The rubber insert fully autoclavable sticks perfectly to the crown and allows an optimal position of the tip during the removal of the band.

Pinze per la rimozione di bande disponibili in 2 misure, lunga e corta. Il gommino sterilizzabile, rimane perfettamente in contatto con la corona, permettendo una ottimale posizione della punta, per la rimozione della banda.



3000/49

Posterior band remover – Short
(mm 135)

3000/50

Posterior band remover – Long
(mm 135)

3000/PR5

Tips spare parts, screwable
Gommini di ricambio, avvitabili

3000/45
(1:1 scale / scala 1:1)



3000/45
Adhesive remover
(mm 140)

*Used to remove composite material
after debonding attachments.*

3000/PR8
Tips spare parts, screwable
Gommini di ricambio, avvitabili



3000/62
Crimpable archwire hook
(mm 130)

For ball hooks and auxiliaries.

3000/36
Crimping plier
(mm 125)

*For crimping bands
or hooks, for placing stops
and tubing on archwires.*



1851
(1:1 scale / scala 1:1)



**Smooth handle
for Smaha forceps**
Manico liscio
per le pinze Smaha

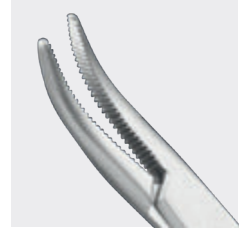

1851 (mm 140)
Smaha

1852 (mm 140)
Smaha
Curved
Curvo

2825/ORTO
(1:1 scale / scala 1:1)



**Grooved handle
for Mathieus**
Manico zigrinato
per Mathieu

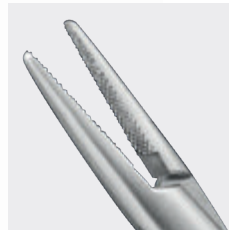

1850 (mm 140)
Mini Mathieu

2825/ORTO (mm 140)
Mini Mathieu smoothed
Smoothed
Liscio



2825 (mm 140)
Plier to place modules
Pinza per moduli



1519 (mm 125)
Halstead Mosquito



2824 (mm 120)
Forceps for placing dentalastics
Pinza per applicare i dentalastics



2826 (mm 165)
Ligature plier with locker
Pinza per legature con fermo

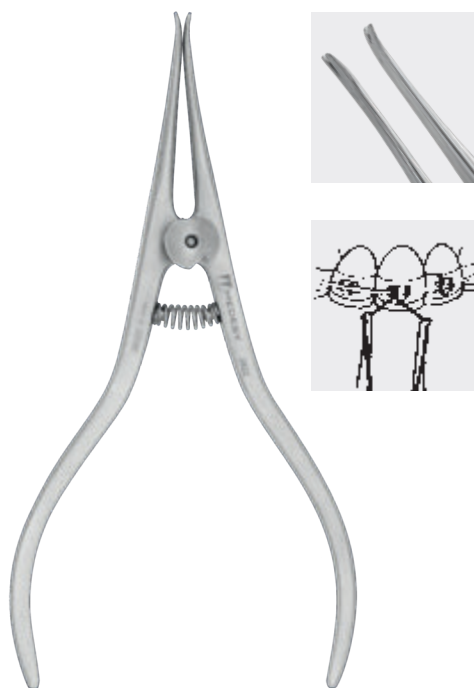

2822 (mm 150)
Steiner
Ligature plier, for applying and stretching
stainless steel ligatures
Pinza per legature, per applicare e tendere le legature



2823 (mm 150)
Separating plier, for an easy placement
of separating elastics
Pinza per separazione, per inserire facilmente gli elastici

(1:1 scale / scala 1:1)

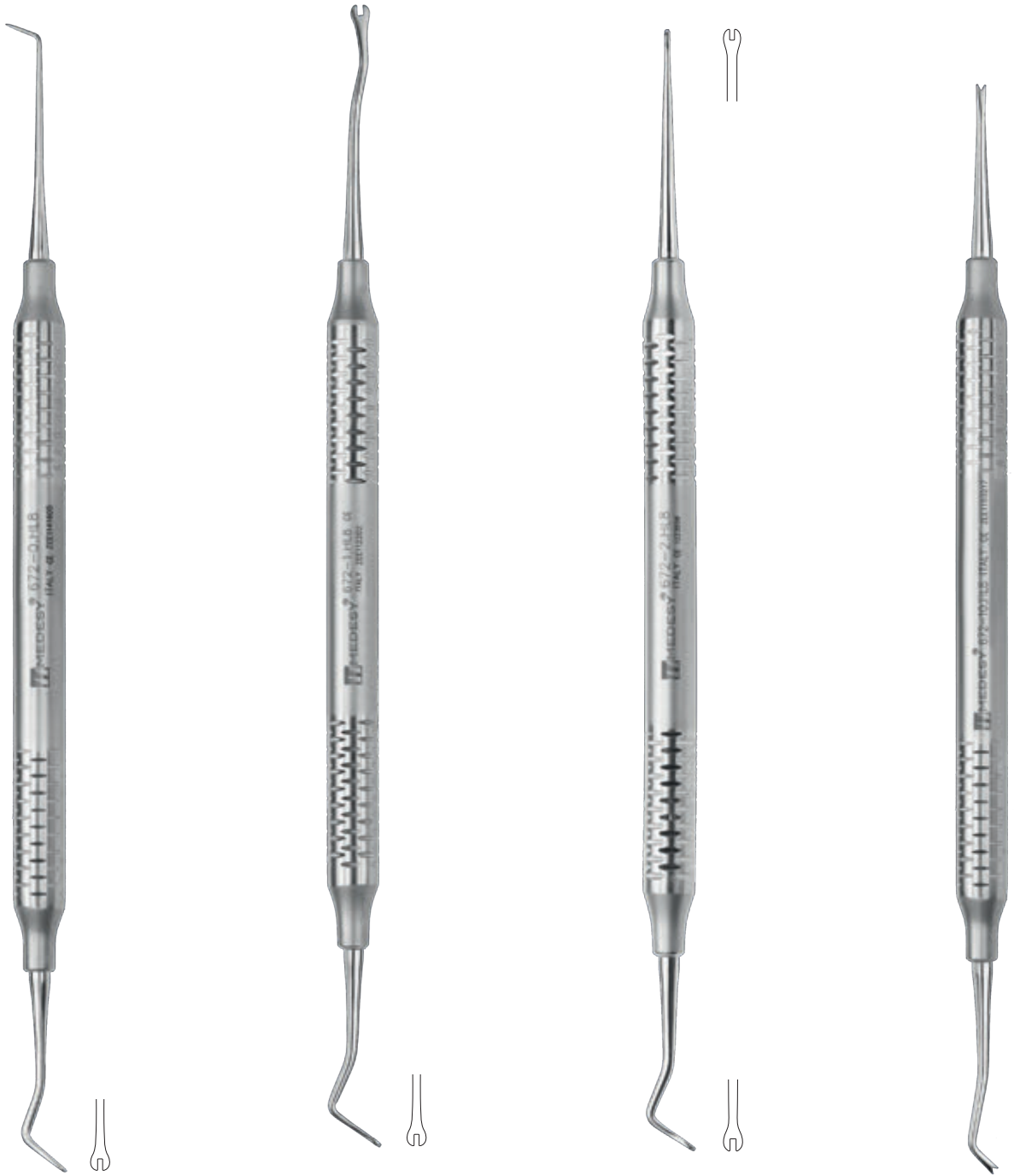

672/0 (∅ mm 6)
672/0.HL8 (∅ mm 8)
672/0.HL10 (∅ mm 10)

Ligature director N. 0
Direzionatore per legature N. 0

672/1 (∅ mm 6)
672/1.HL8 (∅ mm 8)
672/1.HL10 (∅ mm 10)
Tucker N. 1

Ligature director
Direzionatore per legature

672/2 (∅ mm 6)
672/2.HL8 (∅ mm 8)
672/2.HL10 (∅ mm 10)
Tucker N. 2

Ligature director
Direzionatore per legature

672/10 (∅ mm 6)
672/10.HL8 (∅ mm 8)
672/10.HL10 (∅ mm 10)

Ligature director MINI
Direzionatore per legature MINI

(1:1 scale / scala 1:1)



673/1 (ø mm 6)
673/1.HL8 (ø mm 8)
673/1.HL10 (ø mm 10)

Band pusher / scaler MINI
 Spingibande / scaler MINI



673 (ø mm 6)
673.HL8 (ø mm 8)
673.HL10 (ø mm 10)

Band pusher / scaler
 Spingibande / scaler



673/2C (ø mm 6)
673/2C.HL8 (ø mm 8)
673/2C.HL10 (ø mm 10)

Band pusher / scaler
 Spingibande / scaler



674 (ø mm 6)
674.HL8 (ø mm 8)
674.HL10 (ø mm 10)

Elastic ligature applicator
 Applicatore per elastici

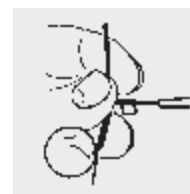

DIRECT BOND BRACKET TWEEZER
PINZETTE PER L'ESATTO POSIZIONAMENTO DEGLI ATTACCHI



1006 (mm 135)

With blade
Con lama

1008 (mm 140)

1009 (mm 140)

1130 (mm 140)

1132 (mm 120)

1134 (mm 140)

Buccal tube tweezer
Pinzetta ausiliaria buccale

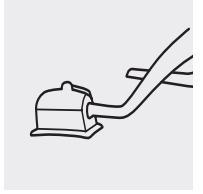

2811

Positioning gauge
Posizionatore per brackets
(mm 65x65)



4874/1 (per slot 018)

4874/2 (per slot 022)

Bracket height Gauge – Aluminium
Altimetro per bracket – Alluminio
(mm 150)

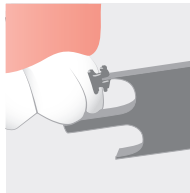

4876/1 (per slot 018)

4876/2 (per slot 022)

Bracket height Gauge – Stainless steel
Altimetro per bracket – Acciaio
(mm 130)



2815/1 (Hole dimension: \varnothing mm 0,75 – 030")

2815/2 (Hole dimension: \varnothing mm 0,55 – 022")

(mm 160)



Auxiliary instrument for the distal bending.
Strumento ausiliario per la piegatura distale.



4870 (mm 150)
Merston
Band pusher
Spingibande



4873/PR
Spare part
Ricambio



4871 (mm 145)
Band seater, autoclavable teflon handle
(available in different colours)
Posizionatore per bande, manico in teflon autoclavabile (disponibile in diversi colori)



2817 (mm 165)
Positioner, aluminium
Posizionatore, alluminio

CROWN AND GOLD SCISSORS



3550 (mm 110)
Beebee
Saw edge, straight
Dentata, retta



3551 (mm 110)
Beebee
Saw edge, curved
Dentata, curva

WIRE SCISSORS

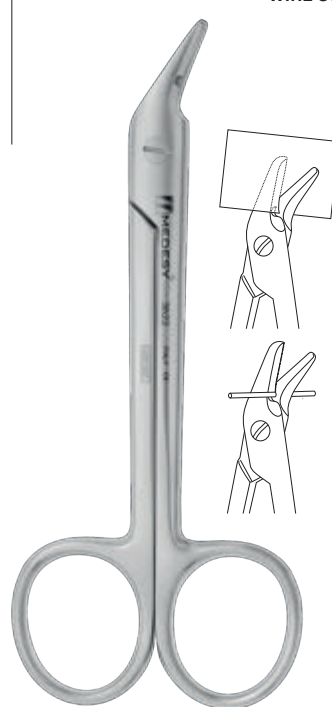

3522 (mm 125)
Universal, saw edge
Universale, dentata



3522/TC (mm 125)
Universal
Universale



1680/1

ORTHO CLASSIC

Content / Contenuto:

1850	Mini Mathieu
3000/31	Weingart plier
3000/69 TC	Distal end n. 69
3000/85 TC	Cutter n. 85
4905/8	Handle with mirror #4
672/1.HL8	Ligature director Tucker n.1
673.HL8	Band pusher / scaler
981/19	Gammatrix tray Quatri



“
MEDESYS IN SPOT
*Content can be changed
 under request*
*Il contenuto può essere
 cambiato a richiesta*
 ”

1680/2

ORTHO ADVANCED

Content / Contenuto:

1006	Bracket tweezer
1850	Mini Mathieu
3000/23 TC	Adams plier
3000/31	Weingart plier
3000/69 TC	Distal end n. 69
3000/85 TC	Cutter n.85
4905/8	Handle with mirror #4
672/1.HL8	Ligature director Tucker n.1
673.HL8	Band pusher / scaler
674.HL8	Elastic ligature applicator
981/19	Gammatrix tray Quatri

1680/3

ORTHO BAND

Content / Contenuto:

3000/31	Weingart plier
3000/49	Band remover short
3000/50	Band remover long
4870	Band pusher
4873	Molar band seater
4905/8	Handle with mirror #4
673.HL8	Band pusher / scaler
673/2C.HL8	Band pusher / scaler
981/19	Gammatrix tray Quatri



1680/4

ORTHO BRACKET

Content / Contenuto:

1006	Bracket tweezer
1008	Bracket tweezer
1009	Bracket tweezer
2817	Positioner
3000/31	Weingart plier
3000/82	Bracket remover
3000/83	Bracket remover
4876/1	Bracket height gauge
4876/2	Bracket height gauge
4905/8	Handle with mirror #4
981/19	Gammatrix tray Quatri

PLIER'S HOLDER

RASTRELLIERE PORTA PINZE



6141
240 × 120 mm
Large rack
Porta pinze lungo



6140
150 × 120 mm
Small rack
Porta pinze corto

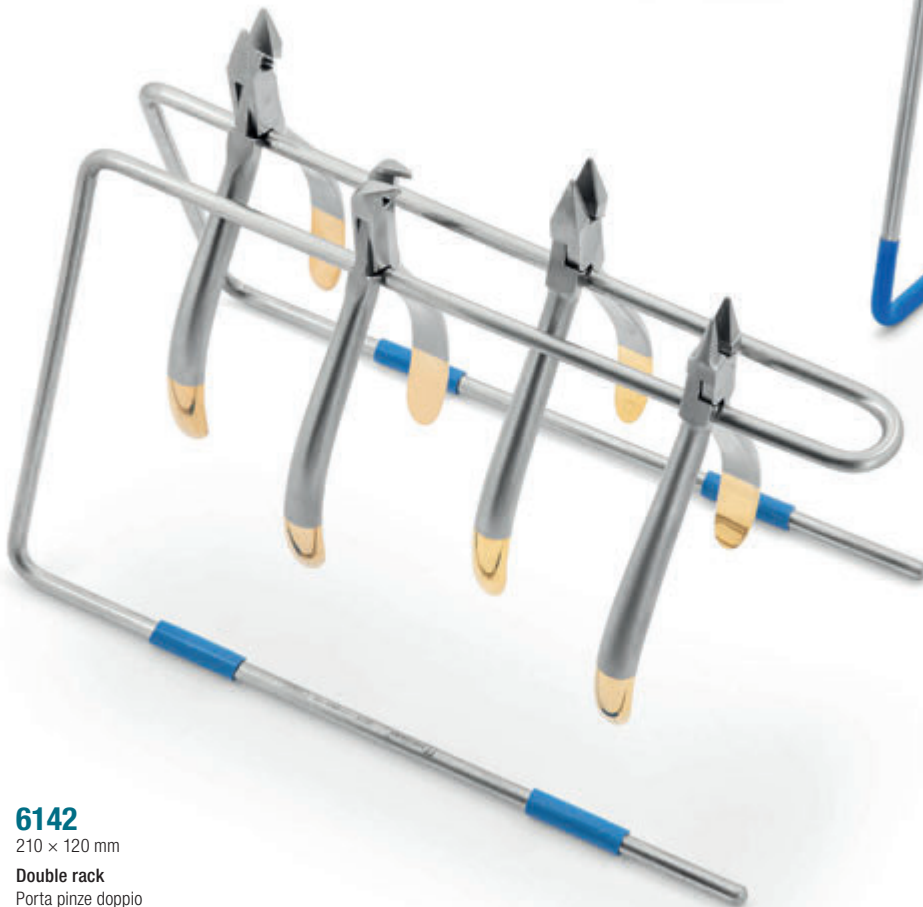

6142
210 × 120 mm
Double rack
Porta pinze doppio

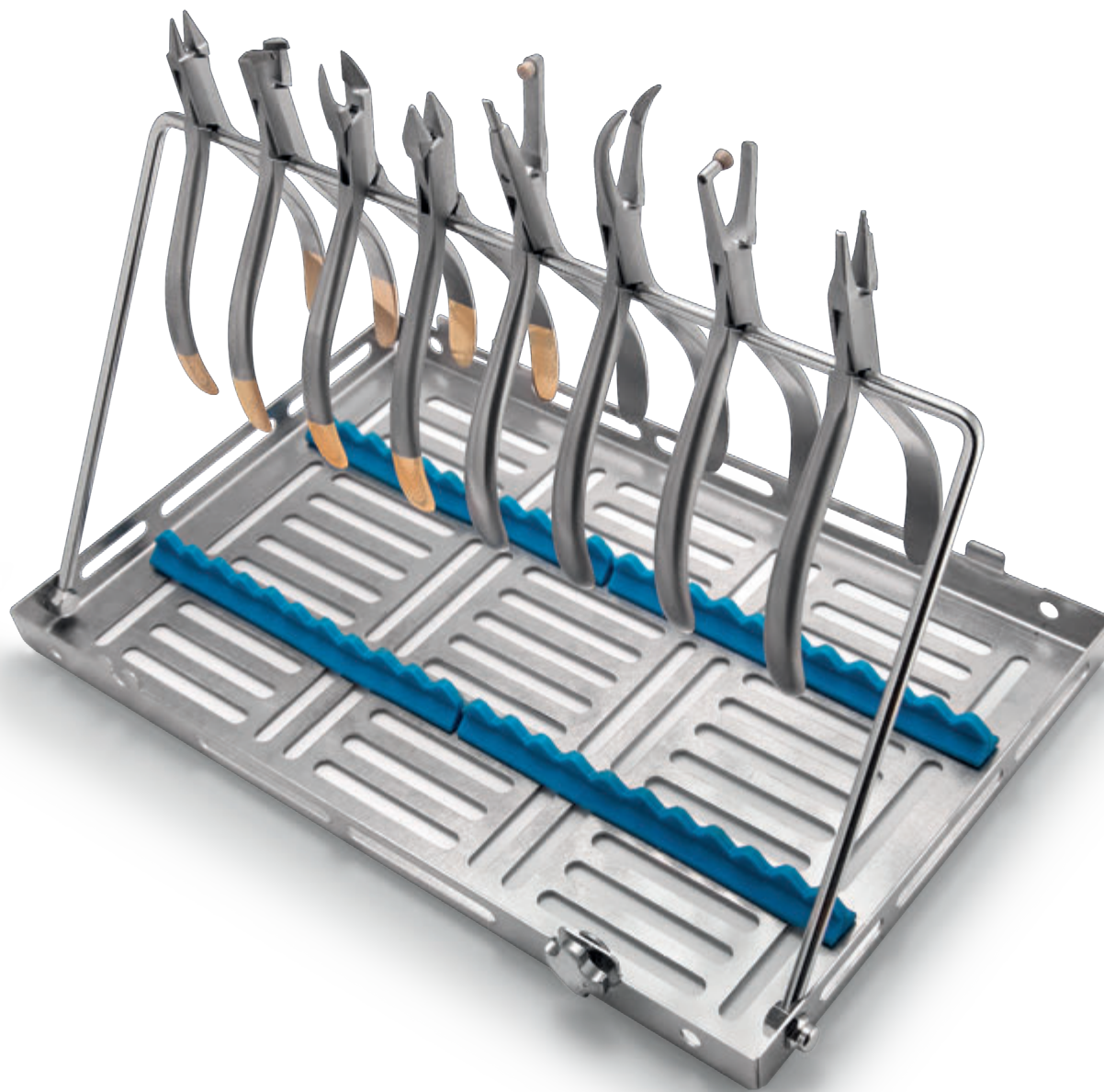

MEDESYS offers a very practical solution for handling your pliers during cleaning and sterilization sections. Our GAMMAFIX trays help on organizing your pliers in practical set ups and handle them safely. Just some of the specific benefits of our GAMMAFIX trays: inserts made of special non-toxic silicon and open corners to facilitate the outflow of residuals and water and therefore reduce the drying time. More info on www.medesy.it

MEDESYS presenta un'ottimale soluzione per maneggiare le pinze ortodontiche durante il processo di pulizia e sterilizzazione. I vassoi della serie GAMMAFIX risultano estremamente pratici e versatili per contenere le pinze ortodontiche in tutta sicurezza. I vassoi GAMMAFIX si distinguono per la loro praticità d'uso ed importanti accorgimenti, tra i quali il silicone atossico e angoli aperti atti a defluire acqua e residui. Maggiori informazioni su www.medesy.it



981/ORTO

Based on 981/20
Gammafix (Cinc)
Basato su 981/20
Gammafix (Cinc)





MEDESY presents the practical and elegant display case solution for orthodontic pliers. Select the pliers according to the needs and carry them, very easy and comfortable. The perfect choice for congresses and exhibitions!

MEDESY presenta la pratica ed elegante valigetta per pinze ortodontiche. Seleziona le pinze in funzione alla necessità per trasportarle in modo comodo e semplice. Ideali per congressi e fiere!



2918/0
cm 55 x 22 x 8
Exposer
Espositore

“
MEDESY IN SPOT
*Content can be changed
under request*
*Il contenuto può essere
cambiato a richiesta*
”





583/1
P.K. Thomas N. 1



583/2
P.K. Thomas N. 2



583/3
P.K. Thomas N. 3



583/4
P.K. Thomas N. 4



583/5
P.K. Thomas N. 5

Stainless steel
handle \varnothing 6 mm
Manico inox con
diametro \varnothing 6 mm



583/KIT
Kit of 5 pieces P.K. Thomas on 977 tray
Kit di 5 pezzi P.K. Thomas su vassoio 977



581/1

P.K. Thomas N. 1

Aluminium handle yellow
Manico in alluminio giallo



581/2

P.K. Thomas N. 2

Aluminium handle red
Manico in alluminio rosso



581/3

P.K. Thomas N. 3

Aluminium handle blue
Manico in alluminio blu



581/4

P.K. Thomas N. 4

Aluminium handle green
Manico in alluminio verde



581/5

P.K. Thomas N. 5

Aluminium handle silver
Manico in alluminio argento

Aluminium handle anodized
in 5 colors ø 8 mm

Manico in alluminio anodizzato
in 5 colori diametro ø 8 mm



581/KIT

Kit of 5 pieces P.K. Thomas on 977 tray
Kit di 5 pezzi P.K. Thomas su vassoio 977



WAX KNIVES COLTELLI PER CERA



201
Fahnenstock
mm 130



202
Fahnenstock
mm 180



205
Lessmann
mm 130



206
Lessmann
mm 180



203
mm 125
With bowl
Con scodellino



204
mm 170
With bowl
Con scodellino



214
Gritmann
mm 170

WAX AND MODELING INSTRUMENTS STRUMENTI PER MODELLARE



599/KIT

Kit of wax and modeling instruments with insulated and autoclavable handle, on 977 tray
Kit di strumenti per modellare con manico isolante ed autoclavabile, su vassoio 977



599/1



599/2



599/3



599/4



599/5

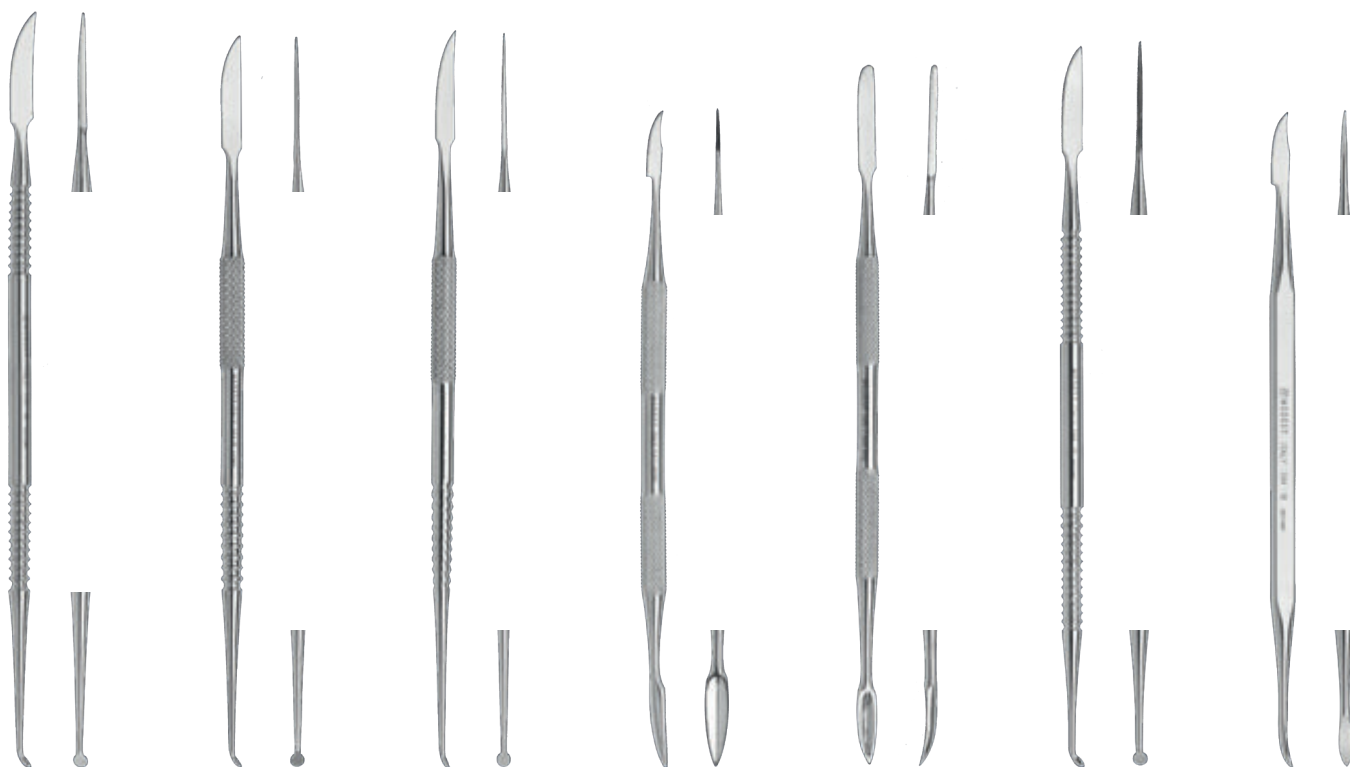

588 (mm 165)
Le Cron

589 (mm 160)
Le Cron

590 (mm 160)
Le Cron

597 (mm 145)
MSY

598 (mm 155)
MSY

599 (mm 160)
Le Cron

594 (mm 135)
Hylin



596 (mm 145)
Hylin

595 (mm 135)
Hylin

591 (mm 120)
Zahle

592 (mm 130)
Zahle

593 (mm 125)
Zahle

610 (mm 180)
Gritman

(1:1 scale / scala 1:1)



676/24
Flexible
Flessibile

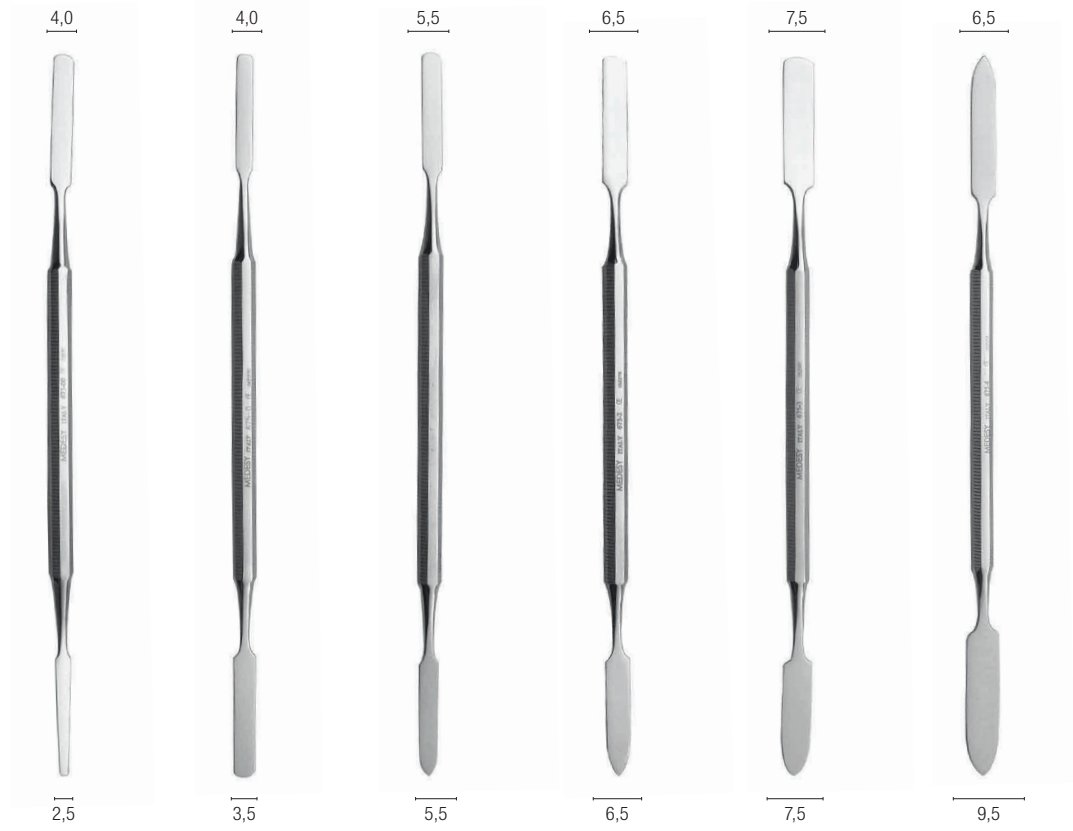

675/00

675/0

675/1

675/2

675/3

675/4



678/3
Weston



676/1
Flexible
Flessibile



677/1
Thin
Sottile



117
mm 220
Flexible
Flessibile



118
mm 195
Flexible
Flessibile



119
mm 195
Flexible
Flessibile

PLASTER AND ALGinate SPATULAS

SPATOLE PER GESSO ED ALGINATO



208
mm 230
Spatula 8 ×
Spatola 8 ×



209
mm 215



210
mm 205



211
mm 200
Curved, rigid
Curva, rigida



213/2
mm 180
Rigid
Rigida



213
mm 180
Rigid
Rigida

ELASTOMERS ELASTOMERI



115
mm 190
Flexible
Flessibile



116
mm 210
Flexible, assorted colors
Flessibile, colori assortiti



Cutting the spatulas from a stainless steel sheet.
Tranciatura delle spatole da un nastro di acciaio.



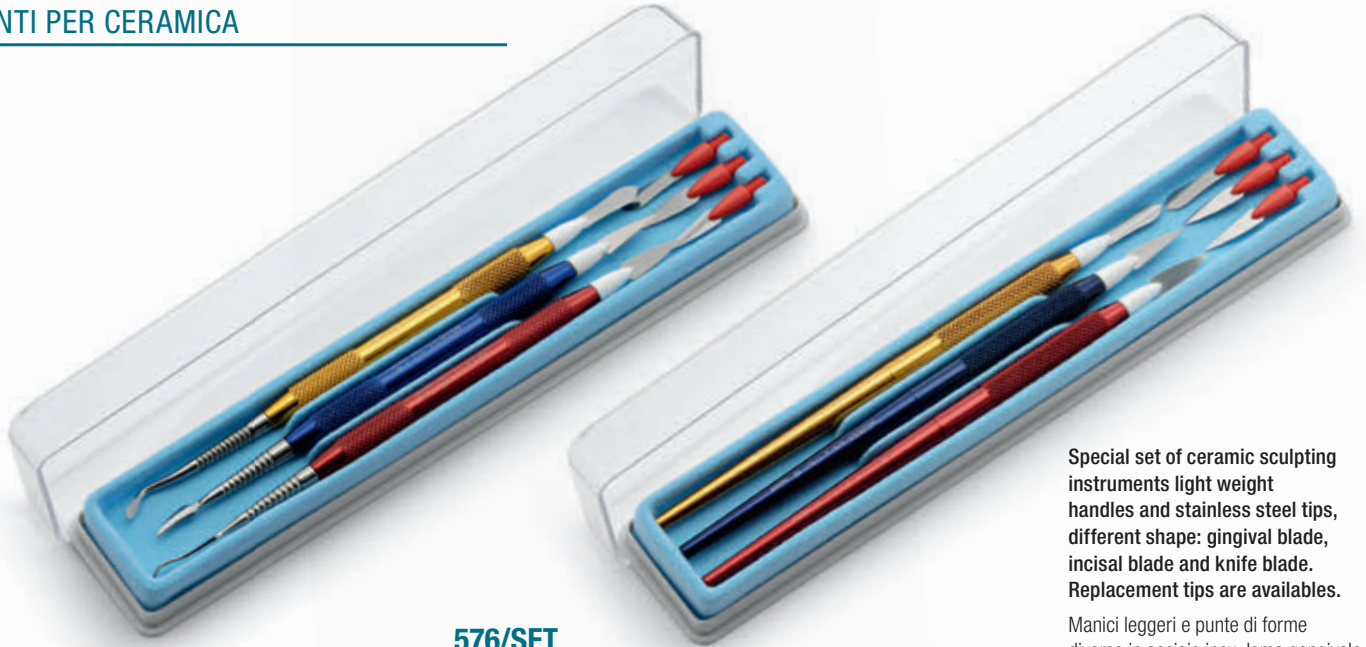

575/SET

576/SET

Special set of ceramic sculpting instruments light weight handles and stainless steel tips, different shape: gingival blade, incisal blade and knife blade. Replacement tips are available.

Manici leggeri e punte di forme diverse in acciaio inox, lama gengivale, lama incisale, lama coltello. Disponibili con puntali di ricambio.

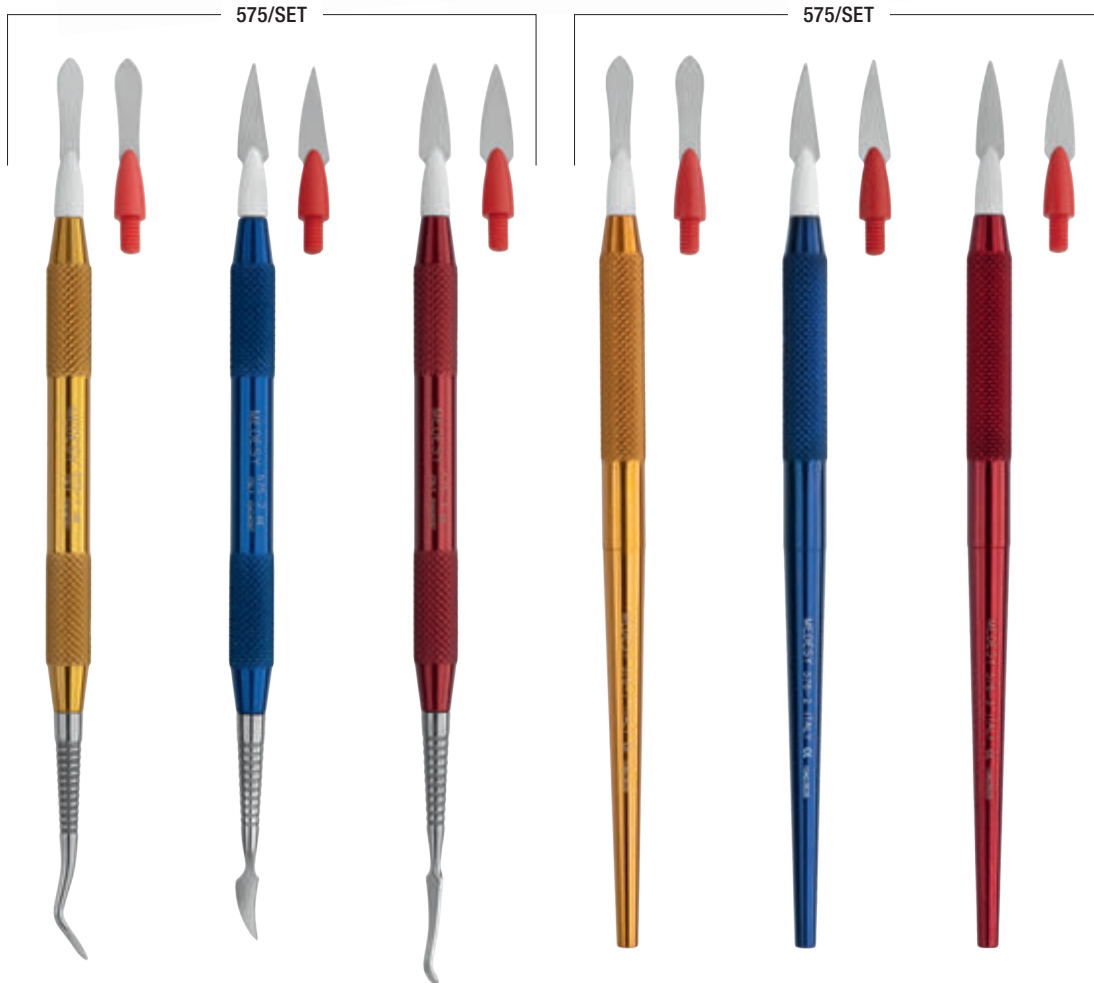

577/1-2-3
mm 0,1
Superflexible Tips
Puntali superflessibili



577/4-5-6
mm 0,2
Flexible Tips
Puntali flessibili

Both instruments are available with flexible or superflexible tips.

Entrambi gli strumenti sono disponibili con puntali flessibili o superflessibili.

575/1

Aluminium handle
Yellow
Manico alluminio
Giallo

575/2

Aluminium handle
Blue
Manico alluminio
Blu

575/3

Aluminium handle
Red
Manico alluminio
Rosso

576/1

Aluminium handle
Yellow
Manico alluminio
Giallo

576/2

Aluminium handle
Blue
Manico alluminio
Blu

576/3

Aluminium handle
Red
Manico alluminio
Rosso

LABORATORY SET

SET PER PROTESI MOBILE E PER TECNICO



2105/SET

Contents / Contenuto

Art. 599 – 593 – 592 – 202 – 206 – 201 – 214 – 221 – 1519 – 3511 – 3522 – 3633 – 4981 – 2810

“ **MEDESYS IN SPOT**

*Content can be changed
upon request*

*Su richiesta il contenuto
può essere cambiato* ”

LABORATORY SET

SET PER CERAMICA E PROTESI FISSA



2100/SET

Contents / Contenuto

Art. 581/1 – 581/2 – 581/3 – 581/4 – 581/5 – 3511 – 1519 – 1024 – 3633 – 596 – 594 – 575/1 – 575/2 – 575/3



MALLETS – PLASTER SHEARS – SAWS

MARTELLETTI – CESOIE PER GESSO – SEGHETTI



949 (mm 200)
Horn tip
Punta in corno



947 (mm 220)
Metal tip
Punta in acciaio Inox



948 (mm 220)
Metal tip
Punta in acciaio Inox



4991/1
For plaster
Package 12 pcs
Per gesso
Sacchetti 12 pezzi

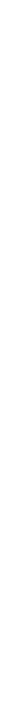

4991/2
For metal
Package 12 pcs
Per metallo
Sacchetti 12 pezzi



4991 (mm 250)
Fret saw
Archetto



4559 (mm 210)
Insulated handle
Manici in plastica



4558 (mm 200)



1645/1 (mm 250)
1645/2 (mm 320)
Crucible tongs
Pinza per cilindri e muffole



4990
mm 180



4990/3
mm 0,12 × 5
Package 12 pcs
Sacchetti da 12 pezzi



4990/2
mm 0,25 × 5
Package 12 pcs
Sacchetti da 12 pezzi



4990/1
mm 0,25 × 3
Package 12 pcs
Sacchetti da 12 pezzi

ARTICULATORS

ARTICOLATORI



Medesy new anatomic articulator, solidly manufactured in cast aluminium, about 400 gr in weight. Projected and realized to ensure the largest visual field on the lingual surfaces as well as maintaining complete stability of the upper frame also at full open position: coiled springs facilitate the return to starting aligned position.

Technical details:

- Opening 125°
- Fixed condylar inclination of 30°
- Intercondylar distance of 110 mm
- Incisal base inclination of 10°
- Bennet angle of 7°
- Distance between the mounting plates 85 mm
- Spare parts available upon request

Questo è il nuovo articolatore anatomico di Medesy, prodotto in alluminio pressofuso dal peso di 400 gr circa. È stato progettato e realizzato in modo da lasciar ampia visibilità alle superfici linguali, preservando la stabilità in posizione aperta: il ritorno in asse è agevolato grazie a delle molle di richiamo.

Dettagli tecnici:

- Apertura 125°
- Inclinazione condilare fissata a 30°
- Distanza intercondilare di 110 mm
- Inclinazione base incisale 10°
- Angolo di Bennet fissato a 7°
- Distanza tra le piastre di montaggio 85 mm
- Parti di ricambio su richiesta



5222

Articulator with mounting plate
Articolatore con piastra



5223

Articulator with magnetic mounting plate
Articolatore con piastra magnetica



5224

Occluder Medesy
Occlusore Medesy



STAINLESS STEEL REGULAR IMPRESSION TRAYS WITH RETENTION RIM

PORTAIMPRONTE FORATE REGOLARI INOX CON IL BORDINO RITENTIVO



Uppers / Sizes (mm) Superiori / Misure (mm)

6000	6000/U1 XXS	6000/U2 XS	6000/U3 S	6000/U4 M	6000/U5 L	6000/U6 XL
	56	65	68	71	73	78
	44	52	54	58	59	63

6000/1UP



6000/4DR



6000/1LP



6000/4SL



Lowers / Sizes (mm) Inferiori / Misure (mm)

6000	6000/L1 XXS	6000/L2 XS	6000/L3 S	6000/L4 M	6000/L5 L	6000/L6 XL
	56	66	70	73	76	78
	44	50	52	56	58	60

STAINLESS STEEL REGULAR IMPRESSION TRAYS WITHOUT RETENTION RIM

PORTAIMPRONTE FORATE REGOLARI INOX SENZA IL BORDINO RITENTIVO



Uppers / Sizes (mm) Superiori / Misure (mm)

6003	6003/U1 XXS	6003/U2 XS	6003/U3 S	6003/U4 M	6003/U5 L	6003/U6 XL
	56	65	68	71	73	78
	44	52	54	58	59	63



6000/KIT
6003/KIT

Contains 12 pcs
Contiene 12 pezzi

6003/4DR



6003/4SL



Lowers / Sizes (mm) Inferiori / Misure (mm)

6003	6003/L1 XXS	6003/L2 XS	6003/L3 S	6003/L4 M	6003/L5 L	6003/L6 XL
	56	66	70	73	76	78
	44	50	52	56	58	60

STAINLESS STEEL ANATOMIC IMPRESSION TRAYS WITH RETENTION RIM

PORTAIMPRONTE ANATOMICHE INOX CON IL BORDINO RITENTIVO



6005/1UP



6005/4DR



6005/1LP



6005/4SL



Uppers / Sizes (mm) Superiori / Misure (mm)

6005	6005/U1 XXS	6005/U2 XS	6005/U3 S	6005/U4 M	6005/U5 L	6005/U6 XL
	56	65	68	71	73	78
	44	52	54	58	59	63

Lower / Sizes (mm) Inferiori / Misure (mm)

6005	6005/L1 XXS	6005/L2 XS	6005/L3 S	6005/L4 M	6005/L5 L	6005/L6 XL
	56	66	70	73	76	78
	44	50	52	56	58	60



4955/S

Brusher
Scovolino



4955/P

Tips, spare part
Puntali di ricambio

Syringe for elastometers, aluminium
Siringa per elastomeri, alluminio
Disponibile in argento, blu, rosso



4955/A

Argentum
Argento



4955/B

Blue
Blu



4955/R

Red
Rosso



574

Modeling knife
Coltello per modellare

6005/KIT

Contains 12 pcs
Contiene 12 pezzi







LABORATORY / LABORATORIO

STAINLESS STEEL IMPRESSION TRAYS EDENTULOUS (COMPLETE DENTURE) SPECIAL FORM



PORTAIMPRONTE PER PROTESI TOTALI – EDENTULI INOX FORMA SPECIALE





		Uppers / Sizes (mm)			Superiori / Misure (mm)	
6009	6009/U1 XXS	6009/U2 XS	6009/U3 S	6009/U4 M	6009/U5 L	
	60	63	68	69	78	
	51	52	58	59	63	

		Lowers / Sizes (mm)			Inferiori / Misure (mm)	
6009	6009/L1 XXS	6009/L2 XS	6009/L3 S	6009/L4 M	6009/L5 L	6009/L6 XL
	60	67	70	74	75	79
	51	52	54	55	55	56



		Uppers / Sizes (mm)			Superiori / Misure (mm)	
6011	6011/U1 XXS	6011/U2 XS	6011/U3 S	6011/U4 M	6011/U5 L	
	60	63	68	69	78	
	51	52	58	59	63	

		Lowers / Sizes (mm)			Inferiori / Misure (mm)	
6011	6011/L1 XXS	6011/L2 XS	6011/L3 S	6011/L4 M	6011/L5 L	6011/L6 XL
	60	67	70	74	75	79
	51	52	54	55	55	56

ALUMINIUM PERFORATED IMPRESSION TRAYS, DISPOSABLE

PORTAIMPRONTE PERFORATE IN ALLUMINIO, MONOUSO

6009/KIT
6011/KIT



Contains 11 pcs
Contiene 11 pezzi





6006/4DR

6006/4SL



		Uppers / Sizes (mm)			Superiori / Misure (mm)	
6006	6006/U1 XXS	6006/U2 XS	6006/U3 S	6006/U4 M	6006/U5 L	6006/U6 XL
	64	66	69	72	74	76
	49	51	54	58	61	64

		Lowers / Sizes (mm)			Inferiori / Misure (mm)	
6006	6006/L1 XXS	6006/L2 XS	6006/L3 S	6006/L4 M	6006/L5 L	6006/L6 XL
	55	59	71	75	77	79
	48	50	52	56	58	60

EHRICKE STAINLESS STEEL IMPRESSION TRAYS

PORTAIMPRONTE IN ACCIAIO INOX MODELLO EHRICKE

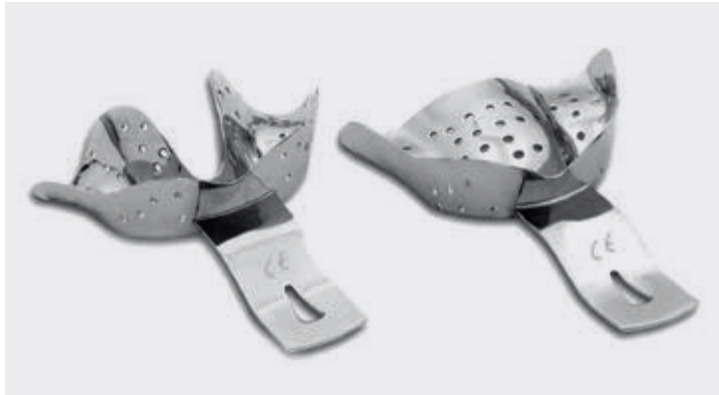

6002/KIT

Partially toothed
Per arcate parzialmente
dentate

Only available
in kit 4 pcs
Disponibile solo
in kit 4 pezzi

Uppers / Sizes (mm)		Superiori / Misure (mm)
6002	6002/U1	6002/U2
	62	70
	50	56

Lowers / Sizes (mm)		Inferiori / Misure (mm)
6002	6002/L1	6002/L2
	70	78
	55	59



6010/KIT

Edentulous jaws
Per arcate edentule

Only available
in kit 6 pcs
Disponibile solo
in kit 6 pezzi

Uppers / Sizes (mm)		Superiori / Misure (mm)	
6010	6010/U1	6010/U2	6010/U3
	64	68	79
	46	53	61

Lowers / Sizes (mm)		Inferiori / Misure (mm)	
6010	6010/L1	6010/L2	6010/L3
	70	70	72
	48	53	57



6001/KIT

Toothed jaws
Per arcate dentate

Only available
in kit 10 pcs
Disponibile solo
in kit 10 pezzi

Uppers / Sizes (mm)		Superiori / Misure (mm)			
6001	6001/U1	6001/U2	6001/U3	6001/U4	6001/U5
	59	66	71	71	80
	52	52	62	64	70

Lowers / Sizes (mm)		Inferiori / Misure (mm)			
6001	6001/L1	6001/L2	6001/L3	6001/L4	6001/L5
	65	67	76	79	79
	46	50	54	56	61



6012/UCB

For narrow toothed
upper jaws
Per arcate superiori
strette dentate

Uppers / Sizes (mm)		Superiori / Misure (mm)
6012	6012/UCB	
	70	
	54	



STAINLESS STEEL EDENTULOUS (COMPLETE DENTURE) RIM LOCK

PORTAIMPRONTE PER PROTESI TOTALI EDENTULI INOX CON IL BORDINO RITENTIVO





6013/KIT



Contains 8 pcs
Contiene 8 pezzi



Uppers / Sizes (mm) Superiori / Misure (mm)

6013	6013/U1 S	6013/U2 M	6013/U3 L	6013/U4 XL
	64	65	73	76
	68	58	58	57

Loweres / Sizes (mm) Inferiori / Misure (mm)

6013	6013/L1 S	6013/L2 M	6013/L3 L	6013/L4 XL
	66	72	76	82
	54	56	60	61

STAINLESS STEEL EDENTULOUS (COMPLETE DENTURE) PERFORATED RIM LOCK

PORTAIMPRONTE PER PROTESI TOTALI EDENTULI INOX FORATE CON IL BORDINO RITENTIVO





6014/KIT



Contains 8 pcs
Contiene 8 pezzi



Uppers / Sizes (mm) Superiori / Misure (mm)

6014	6014/U1 S	6014/U2 M	6014/U3 L	6014/U4 XL
	65	66	72	77
	58	63	61	68

Loweres / Sizes (mm) Inferiori / Misure (mm)

6014	6014/L1 S	6014/L2 M	6014/L3 L	6014/L4 XL
	65	72	75	83
	56	60	61	62

STAINLESS STEEL ORTHODONTIC (CHILDREN) RIM LOCK

PORTAIMPRONTE ORTODONTICHE INOX CON IL BORDINO RITENTIVO



6017/KIT

Contains 8 pcs
Contiene 8 pezzi



Uppers / Sizes (mm) Superiori / Misure (mm)

6017	6017/U1 S	6017/U2 M	6017/U3 L	6017/U4 XL
	52	58	59	60
	41	42	49	50

Lowers / Sizes (mm) Inferiori / Misure (mm)

6017	6017/L1 S	6017/L2 M	6017/L3 L	6017/L4 XL
	57	62	69	70
	42	48	49	50

STAINLESS STEEL ORTHODONTIC (CHILDREN) PERFORATED RIM LOCK

PORTAIMPRONTE ORTODONTICHE INOX PERFORATE CON IL BORDINO RITENTIVO



6018/KIT

Contains 8 pcs
Contiene 8 pezzi



Uppers / Sizes (mm) Superiori / Misure (mm)

6018	6018/U1 S	6018/U2 M	6018/U3 L	6018/U4 XL
	52	58	59	60
	41	42	49	50

Lowers / Sizes (mm) Inferiori / Misure (mm)

6018	6018/L1 S	6018/L2 M	6018/L3 L	6018/L4 XL
	57	62	69	70
	42	48	49	50



DISPOSABLES IMPRESSION TRAYS PORTAIMPRONTE MONOUSO

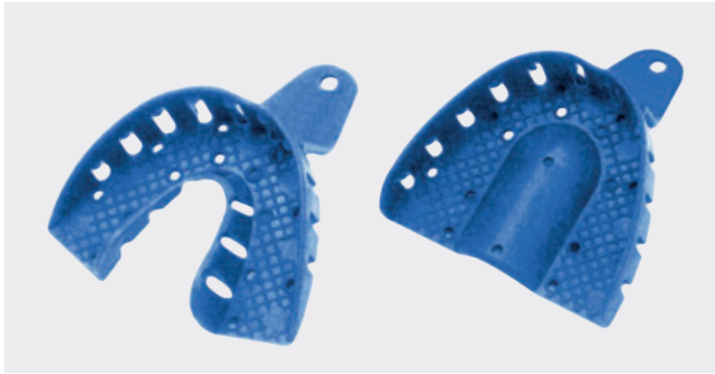

6007/24

Set of 24 assorted pieces
Confezione da 24 pz. assortiti

6007/100

Set of 100 assorted pieces
Confezione da 100 pz. assortiti



Uppers / Sizes (mm) Superiori / Misure (mm)

6007	6007/U1 XXS	6007/U2 XS	6007/U3 S	6007/U4 M
	61	65	70	73
	49	53	59	63

Loweres / Sizes (mm) Inferiori / Misure (mm)

6007	6007/L1 XXS	6007/L2 XS	6007/L3 S	6007/L4 M
	61	67	72	74
	50	52	56	58

POLYCARBONATE IMPRESSION TRAYS PORTAIMPRONTE IN POLICARBONATO



6008/24 KIT

Series of 24 polycarbonate impression trays and compasses for final impressions
Serie di 24 portaimpronte in polycarbonato più compasso per impronte definitive

For edentulous or partially toothed bites, autoclavable (more info upon request).
Per bocche edentule o parzialmente dentate, autoclavabile (su richiesta maggiori informazioni).

Uppers / Sizes (mm) Superiori / Misure (mm)

6008	6008/U1	6008/U2	6008/U3	6008/U4	6008/U5	6008/U6	6008/U7
	62	63	64	66	70	75	77
	54	58	58	60	62	63	64

Partials / Sizes (mm) Parziali / Misure (mm)

6008	6008/P1	6008/P2	6008/P3	6008/P4
	64	67	75	76
	63	57	49	53

Loweres / Sizes (mm) Inferiori / Misure (mm)

6008	6008/L1	6008/L2	6008/L3	6008/L4	6008/L5	6008/L6	6008/L7	6008/L8	6008/L9	6008/L10	6008/L11	6008/L12	6008/L13
	57	58	60	61	61	61	62	64	64	66	65	67	70
	49	53	54	55	56	57	57	55	59	57	60	58	59

STAINLESS STEEL REGULAR IMPRESSION TRAYS WITH RETENTION RIM – SATIN FINISH

PORTAIMPRONTE FORATE REGOLARI INOX CON IL BORDINO RITENTIVO, SATINATE



6000/KIT-SB



New micro sandblasted surface on the stainless steel impression trays of range 6000: the special treatment ensures a higher adhesion of the impression materials and thus a finest quality of the final imprint.

Nuova superficie microsabbata per le portaimpronte in acciaio inox della serie 6000: tale trattamento assicura una migliore adesione del materiale da impronta e conseguentemente la qualità del lavoro finale.

FORCEPS FOR ARTICULATING PAPER PINZE PER CARTA DI ARTICOLAZIONI



4584
mm 155

4583
Miller
mm 155



4585
mm 140
Full arch paper holder
Pinze per carta di articolazione

SOLDERING TWEEZERS PINZETTE PER SALDATURA



Fiber handles
Manico in fibra

221
mm 165
Straight
Retta

222
mm 160
Curved
Curva



LABORATORY / LABORATORIO

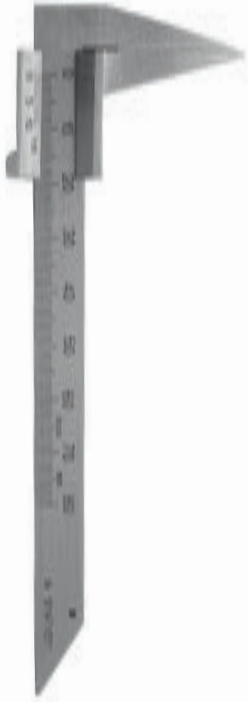

4983 (mm 130)
Beerendonk

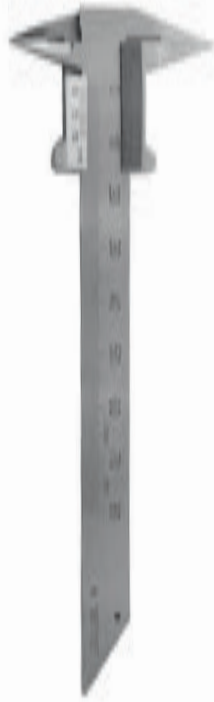

4984 (mm 130)
Züricher



4982 (mm 145)
Boley



4980/C



4981/M



4980/C (For wax / Per cera)
4981/M (For metal / Per metallo)
Iwanson
mm 100



4988 (mm 180)
Steel ruler
Righello in acciaio



4985 (mm 130)
Caliper flat
Calibro piatto

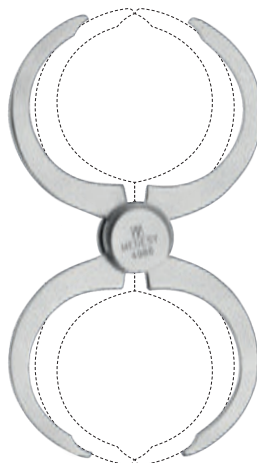

4986
Caliper compass
Calibro a compasso



4989 (mm 125)
Caliper Medesy
Calibro Medesy



*Universal pin bending plier.
Bends wire up to 0,9 mm.
Cuts wire up to 0,7 mm.*

2810 (mm 155)
Universal
Wire bending pliers
Pinze piega fili





Watch the video!
Guarda il video!



GAMMAFIX[®]

by MEDESYS[®]

The revolutionary GAMMAFIX trays are characterized by excellent quality and functionality features, specifically conceived to facilitate the cleaning and sterilization process. Their special shape ensures a fully safe handling of the surgical instruments during the washing and sterilization phase, considerably reducing the risk of accidental injuries for the user. Thanks to the GAMMAFIX trays you can reduce the preparation time as you can organize them in handy and practical set-ups including the different items for each specific dental treatment. The range consists of 5 modular models, studied to offer the best versatility and efficiency. The type of silicone we selected for our trays meets the approval of the strictest Food & Drug standards (FDA).

I rivoluzionari vassoi della linea GAMMAFIX si caratterizzano per l'alta qualità e funzionalità, specificatamente studiati per facilitare il processo di pulizia e sterilizzazione. La loro speciale forma permette di maneggiare lo strumentario chirurgico in massima sicurezza, anche durante le procedure di disinfezione e sterilizzazione, riducendo considerevolmente il rischio di ferite accidentali per l'utilizzatore. Grazie ai vassoi GAMMAFIX si riesce a limitare il tempo di preparazione, in quanto gli strumenti necessari per ogni attività odontoiatrica potranno essere riposti in pratici sets pronti all'uso. La gamma si articola in 5 modelli modulari, studiati al fine di offrire la massima versatilità. Il tipo di silicone prescelto è conforme ai severi requisiti Food & Drug (FDA).



A
The exclusive locking system, keeps the tray perfectly closed. The mark on the locking knob shows the open / close position.

L'esclusivo ed efficace sistema di chiusura. La fresatura indica la posizione di apertura / chiusura.

B
Open corners facilitate the outflow of residuals and water, reduce the drying time.

Angoli aperti agevolano l'uscita di acqua e residui, riducendo i tempi di asciugatura.

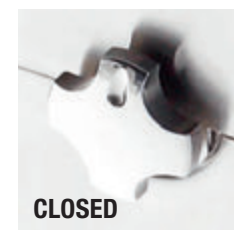

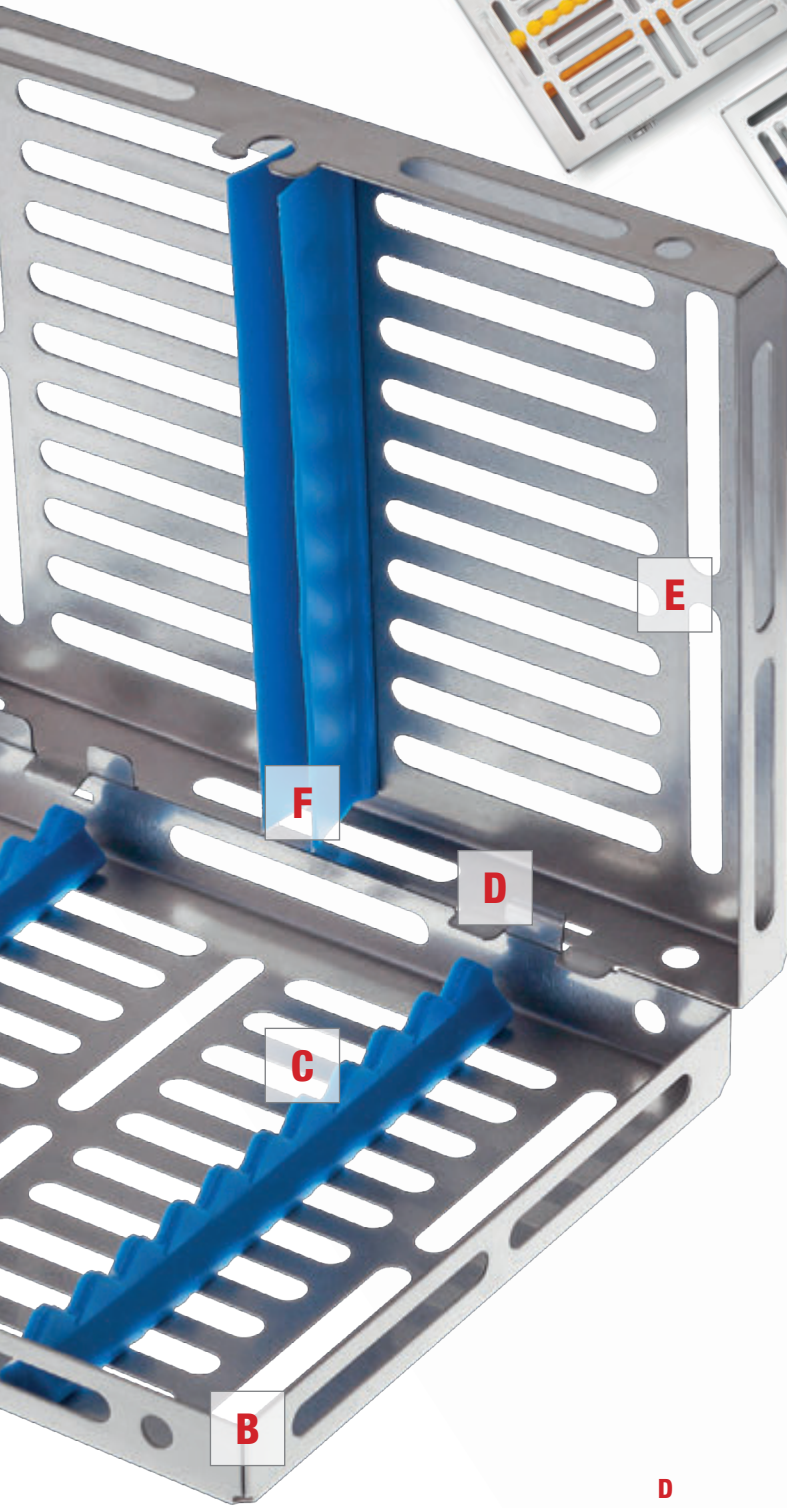

C
The type of silicone we use for our trays meets the approval of the strictest Food & Drug standards (FDA).
Il silicone utilizzato rispetta la severa normativa Food & Drug (FDA).



D
A safe and easy joint system.
Sicuro e semplice meccanismo di chiusura.

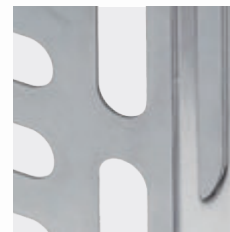

E
The enlarged holes offer more open space for a perfect washing process and a safe sterilization.
I fori di dimensione maggiore assicurano una maggiore capacità di lavaggio ed una efficace sterilizzazione.

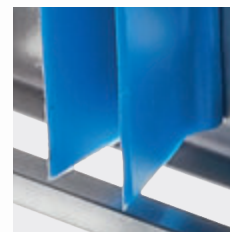

F
Improved top flexible V-Shape for the silicone profile, specifically conceived for storing instruments having different sizes.
Barretta in silicone forma V migliorata, concepita per trattenere strumenti di sezioni diverse.



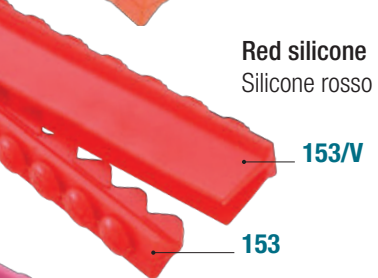
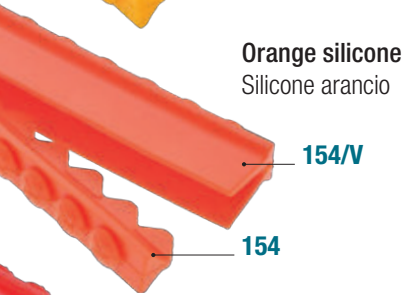
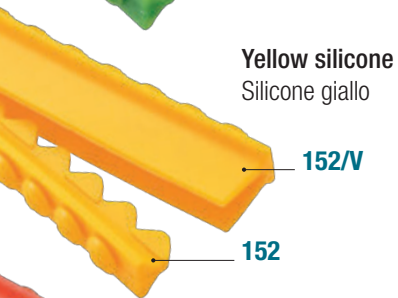
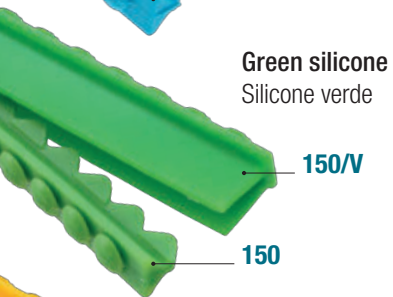
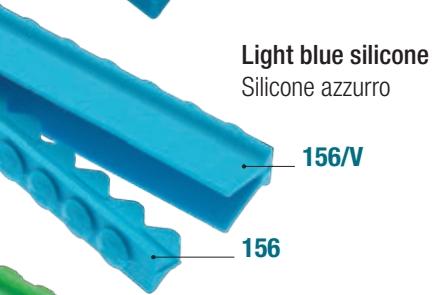
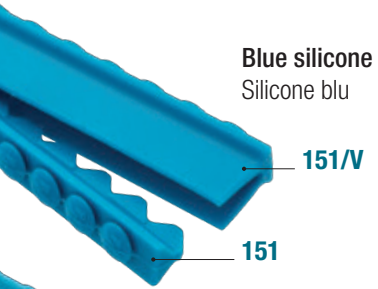

978 (UN)

978/VE with green silicone
978/BL with blue silicone
978/GI with yellow silicone
978/RO with red silicone

978/AR with orange silicone
978/RA with pink silicone
978/AZ with light blue silicone

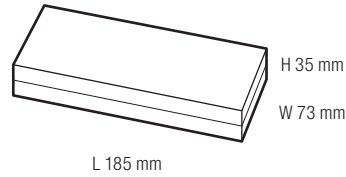

980/9 (DOI)

980/9-VE with green silicone
980/9-BL with blue silicone
980/9-GI with yellow silicone
980/9-RO with red silicone

980/9-AR with orange silicone
980/9-RA with pink silicone
980/9-AZ with light blue silicone

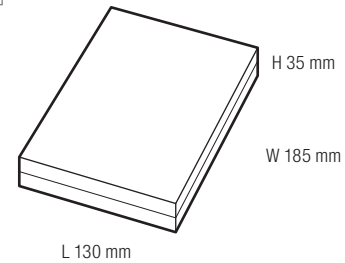

980/10 (TRE)

980/10-VE with green silicone
980/10-BL with blue silicone
980/10-GI with yellow silicone
980/10-RO with red silicone

980/10-AR with orange silicone
980/10-RA with pink silicone
980/10-AZ with light blue silicone

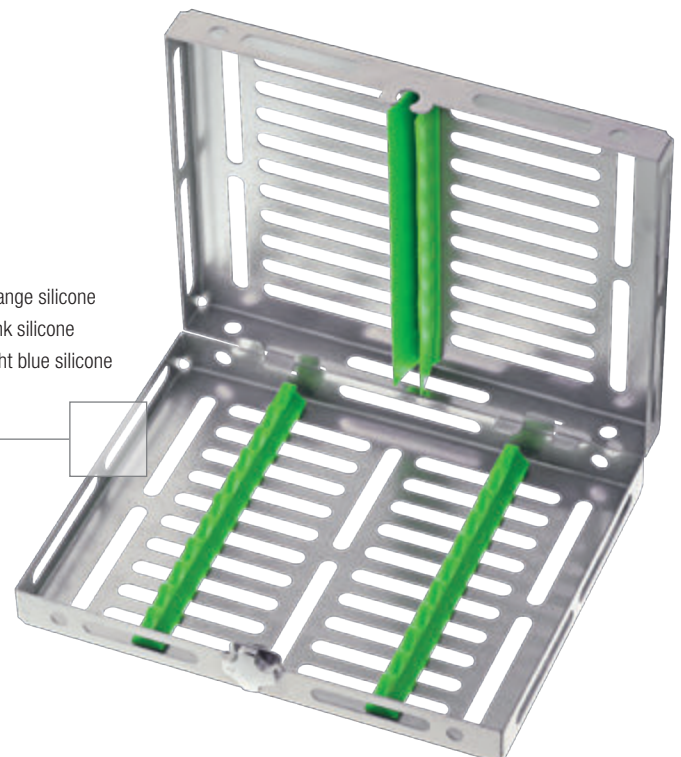
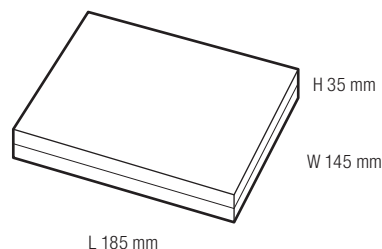



981/19 (QUATRI)

- 981/19-VE** with green silicone
- 981/19-BL** with blue silicone
- 981/19-GI** with yellow silicone
- 981/19-RO** with red silicone
- 981/19-AR** with orange silicone
- 981/19-RA** with pink silicone
- 981/19-AZ** with light blue silicone

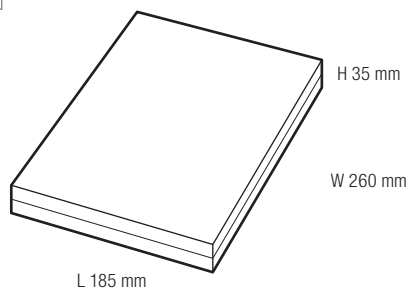

981/20 (CINC)

- 981/20-VE** with green silicone
- 981/20-BL** with blue silicone
- 981/20-GI** with yellow silicone
- 981/20-RO** with red silicone
- 981/20-AR** with orange silicone
- 981/20-RA** with pink silicone
- 981/20-AZ** with light blue silicone

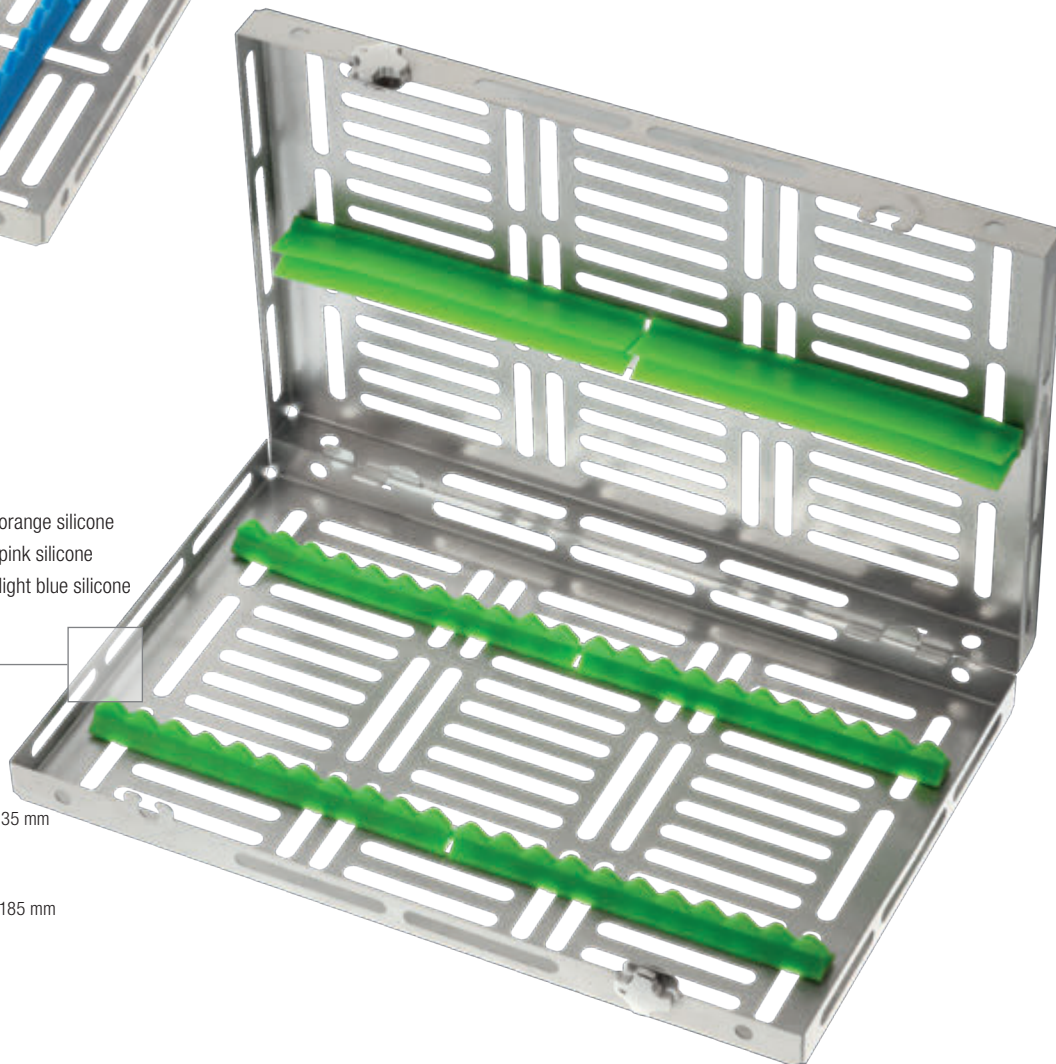
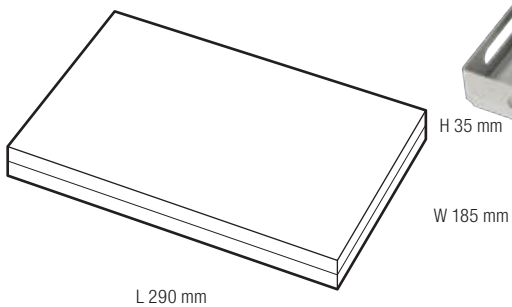

CONTAINERS



962
300 × 190 × 40 mm



963
300 × 190 × 65 mm



964
300 × 190 × 130 mm

Medesy new containers: both tray and lid are perforated to facilitate all type of sterilization; all made in aluminium, which offer special versatility a low weight, characteristic. The containers are supplied with a filter and may be used to hold sterile instruments as well as contaminated tools prior to sterilization.

I nuovi container Medesy sono perforati sia sul coperchio sia sulla base per agevolare tutti i tipi di sterilizzazione; abbiamo scelto di produrli in alluminio in quanto miglior compromesso in termini di peso e versatilità. I container sono utili sia per contenere strumenti sterili sia per riporre strumenti contaminati. I container vengono forniti già con un filtro.

963/F
Disposable paper filter, pack of 100 pcs
Filtri di ricambio monouso, confezione da 100 pz

Safe locking system
Sicuro sistema di chiusura

Anti-slipage pin
Perno antiscivolo



STERILIZATION DRUMS

CESTELLI PER STERILIZZAZIONE



1004/0
 ø mm 190 × 165
Drum inox N. 0
 Cestello inox N. 0



1004/1
 ø mm 150 × 150
Drum inox N. 1
 Cestello inox N. 1



1004/2
 ø mm 125 × 125
Drum inox N. 2
 Cestello inox N. 2

Cylindrical dressing drum sterilizers in stainless steel, with sliding strips and locking mechanism with hinges. Available in 3 diameter sizes from 125 mm to 190 mm.

Cestelli cilindrici per sterilizzazione in acciaio inox, con fasce scorrevoli e chiusura a cerniera. Sono disponibili in 3 misure, da 125 mm a 190 mm di diametro.

TRAY AND HOLDER

VASSOIO E PORTA STRUMENTI

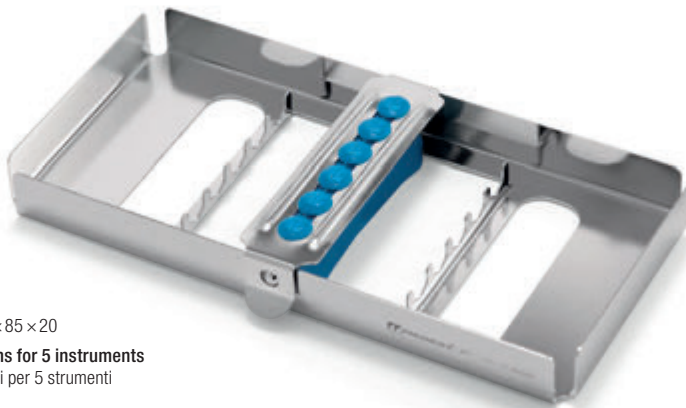

977
 mm 185 × 85 × 20
5 positions for 5 instruments
 5 posizioni per 5 strumenti

1660/1
 mm 70 × 130
Instrument holder
 Porta strumenti



INSTRUMENTS SEIZING AND STERILIZING FORCEPS

PINZETTE COGLI/TRATTIENI

Specific tweezers conceived to ensure a safe handle of surgical instruments during cleaning and disinfection procedures. The tweezers code 1011 allow you to secure the protective cap on the used syringe needles avoiding the risk of injury and infection.

Pinze sviluppate per maneggiare gli strumenti chirurgici durante la fase di pulizia e disinfezione in tutta sicurezza. Inoltre con la pinzetta 1011 è possibile chiudere il cappuccio protettivo degli aghi usati delle siringhe evitando così il rischio di ferite ed infezioni.

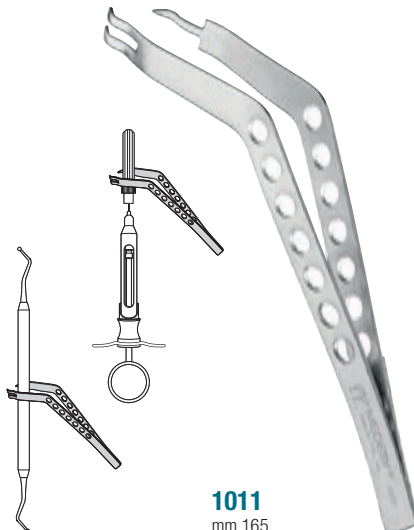

1011
 mm 165

1640 (mm 200)
1641 (mm 300)



1642
 Cheatle
 mm 270





957/2
mm 75 × 54 × 60
15 holes
15 posizioni



957/5
mm 195 × 90 × 35



957/6
mm 260 × 160 × 24
10 positions
10 posizioni

Our polysulfone trays are made of the best engineered polymers which grant excellent thermal and mechanical resistance. The trays have no sharp edges, facilitating cleaning and sanitizing procedures as well as ensuring safe transportation and handling of the surgical products. The trays are autoclavable up to 134°C / 273°F.

I nostri vassoi in polysulfone sono prodotti con i migliori polimeri, i quali garantiscono una eccellente resistenza termica e torsione meccanica. I vassoi hanno gli angoli smussi, i quali facilitano le procedure di pulizia in tutta sicurezza, anche durante il trasporto dello strumentario chirurgico. I vassoi sono autoclavabili fino a 134°C / 273°F.



957/7
mm 260 × 160 × 60
Double deck
Doppio ripiano



Silicon mat
Tappeto in silicone

- 979/BL** (Blue – Blu)
- 979/G** (Green – Verde)
- 979/R** (Red – Rosso)
- 979/W** (White – Bianco)

mm 190 × 90 × 25



Cassette made of plastic, extremely light and versatile, equipped with 3 silicone soft mats to contain various instruments. Available in 4 different colours the cassette offers an optimal solution for rinsing and sterilizing dental and surgical tools.

Cassetta in plastica molto leggera e versatile, dotata di 3 supporti in silicone morbido contenitivo. Risulta adatta alle fasi di lavaggio e sterilizzazione per lo strumentario odontoiatrico e chirurgico. Disponibile in 4 colori.





1002/1
mm 210 × 100 × 30
Capacity / Capacità: 0,4 litre
Kidney bowls
Bacinella reniforme



1002/2
mm 280 × 150 × 40
Capacity / Capacità: 1 litre
Kidney bowls
Bacinella reniforme



1165
mm 230 × 155 × 50
Capacity / Capacità: 0,9 litre



1160
mm 310 × 195 × 55
Capacity / Capacità: 2 litre



1155
mm 220 × 165 × 20
Capacity / Capacità: 0,4 litre

LARGE / GRANDE

mm 290 × 190 × 30



1000/V

Tray
Vassoio

1001/C

Lid
Coperchio

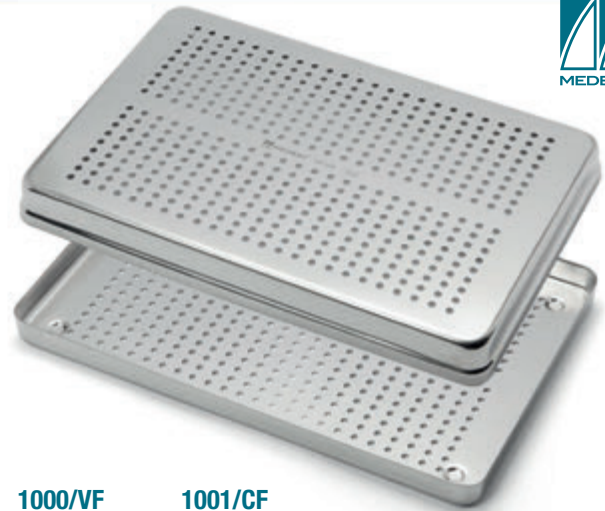

1000/VF

Perforated tray
Vassoio forato

1001/CF

Perforated lid
Coperchio forato

SMALL / PICCOLO

mm 190 × 145 × 25

1005/C

Lid
Coperchio



1005/V

Tray
Vassoio

1005/FC

Perforated lid
Coperchio forato



1005/FV

Perforated tray
Vassoio forato

RACK / RASTRELLIERE

FOR LARGE LID
PER VASSOIO GRANDE

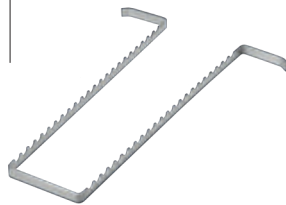

984

23 positions

Stainless steel
Acciaio inox

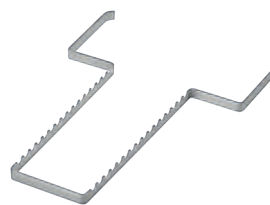

984/A

17 positions

Aluminium
Alluminio

983

16 positions

Stainless steel
Acciaio inox

983/A

11 positions

Aluminium
Alluminio



FOR SMALL LID
PER VASSOIO PICCOLO



982

8 positions

Stainless steel
Acciaio inox

982/A

8 positions

Aluminium
Alluminio



REGULAR

Tray / Vassoio: mm 285 × 185 × 15
Lid / Coperchio: mm 290 × 190 × 30

Lid
Coperchio

999/A
Silver / Argento
Regular



998/A
Silver / Argento
Regular



998/B
Blue / Blu
Regular



998/R
Red / Rosso
Regular



998/D
Golden / Dorato
Regular



998/V
Green / Verde
Regular

PERFORATED / FORATI

Lid
Coperchio

999/FG
Silver / Argento
Regular

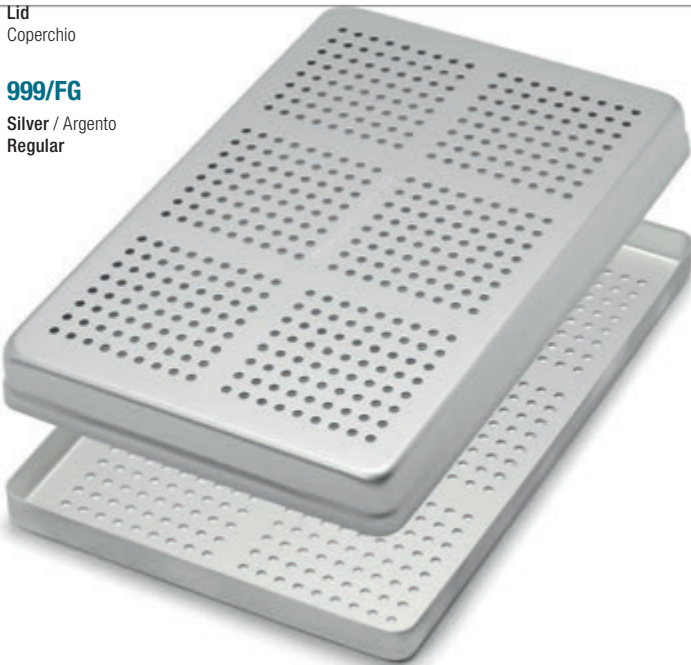

998/FA
Silver / Argento
Regular



998/FB
Blue / Blu
Regular



998/FR
Red / Rosso
Regular

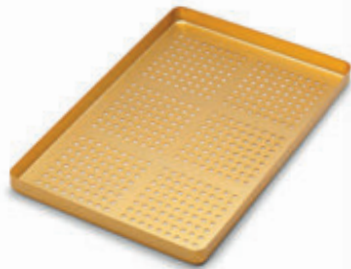

998/FD
Golden / Dorato
Regular

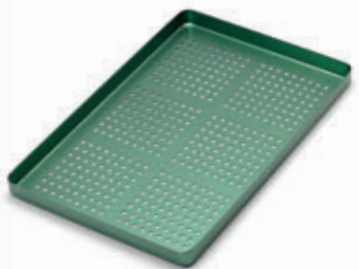

998/FV
Green / Verde
Regular

SMALL

Tray / Vassoio: mm 185 × 140 × 15
Lid / Coperchio: mm 190 × 145 × 25



Lid
Coperchio

999/AS

Silver / Argento
Small



998/AS

Silver / Argento
Small



998/BS

Blue / Blu
Small



998/RS

Red / Rosso
Small



998/DS

Golden / Dorato
Small



998/VS

Green / Verde
Small

PERFORATED / FORATI

Lid
Coperchio

999/FGS

Silver / Argento
Small



998/FAS

Silver / Argento
Small



998/FBS

Blue / Blu
Small



998/FRS

Red / Rosso
Small



998/FDS

Golden / Dorato
Small

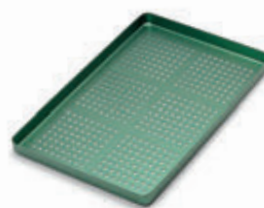

998/FVS

Green / Verde
Small



1150

ø mm 40 inox



1152

ø mm 85 inox

Capacity / Capacità: 0,1 litre



1151

ø mm 65 inox

Capacity / Capacità: 0,05 litre



1149

ø mm 25 inox

Cup with finger holder
Tazza con poggia dito

1148

ø max mm 45

Cup graduated
Tazza con scala graduata



6300

mm 150 x 80 x 15

Mixing glass
Piastra vetro per impasti



215/1 (ø mm 100 – Capacity / Capacità: 0,3 litre)

215/2 (ø mm 120 – Capacity / Capacità: 0,5 litre)

215/3 (ø mm 140 – Capacity / Capacità: 0,8 litre)

Mixing bowls for plaster and alginates
Tazze per alginato e gesso



WASTE CONTAINER, ALUMINIUM
CONTENITORE PORTA RIFIUTI, ALLUMINIO

ø 70 × 75 mm



975/G
Silver / Argento



975/D
Yellow / Giallo



975/R
Red / Rosso



975/V
Green / Verde



975/B
Blue / Blu

COTTON DISPENSER, ALUMINIUM
DISTRIBUTORE DI COTONE, ALLUMINIO

ø 55 × 75 mm



974/G
Silver / Argento



974/D
Yellow / Giallo



974/R
Red / Rosso



974/V
Green / Verde



974/B
Blue / Blu

6161/A (Silver / Argento)
6161/W (White / Bianco)
6161/B (Blue / Blu)

mm 85 × 85 × 360

Drinking cup dispenser
Distributore di bicchieri



6162
mm 45 × 45 × 50

Cotton pellet dispenser
Distributore di palline di cotone



ACCESSORIES / ACCESSORI



6210

Napkin holder, 10 pcs
Catenelle appendi bavagli, 10 pz



MEDESYS disposable saliva ejectors made in PVC atoxic, with metal wire, rounded cap for a perfect aspiration, flexible. Transparent plastic bags of 100/each and cartons of 1000/each.

Aspirasaliva monouso MEDESYS, in PVC non tossico, con filo metallico incorporato, cappuccio arrotondato per una perfetta aspirazione, flessibile. Imballati in sacchetti trasparenti da 100/pz. e cartoni da 1000/pz.

6100/15 (Neutral / Trasparenti)

6100/15 Blu (Blue / Blu)

6100/15 Verdi (Green / Verdi)



220

Tweezers porte films
Pinzette porta lastrine inox



6163

Alcohol burner
Lampada ad alcool

6163/S

Spare wick
Stoppino di ricambio



2821

Protesis carrier, assorted colors
Portaprotesi in plastica, colori assortiti



8400

Mayo instrument table for practice and operating room.

Table's dimensions: mm 630 × 450 × 25 h

Table's elevation: mm 900 to mm 1250

Tavolo di Mayo, per studio e sala operatoria.

Dimensioni del tavolo: mm 630 × 450 × 25 h

Elevazione del tavolo: mm 900 a mm 1250

LUBRICANT OIL WITH SPECIAL THIN DISPENSER NOZZLE

Lubricant oil: when used regularly it protects reliably from wear and prolongs the efficiency of the instrument.

The lubricant oil ensures that all hinged and jointed instruments keep operating smoothly and delicately and also protects them from corrosion and residues.

It is advisable to use the oil prior to sterilization procedures. Physically inert.

OLIO LUBRIFICANTE CON SPECIALE EROGATORE SOTTILE

Olio lubrificante: se usato regolarmente prolunga la durata e l'efficienza dello strumento.

L'olio lubrificante di Medesy favorisce il movimento scorrevole e delicato degli strumenti a snodo, proteggendo al tempo stesso da corrosione e sedimenti.

Si raccomanda di utilizzarlo antecedentemente la fase di sterilizzazione; è fisicamente inerte.



4155

12 ml

Tip length 7 mm

Lunghezza punta 7 mm



4160

12 ml

Tip length 40 mm

Lunghezza punta 40 mm





3161
mm 90
Cuticle scissors
Forbici per pelli



3164
mm 90
Cuticle scissors
Forbici per pelli



3187
mm 90
Nail scissors baby
Forbici per unghie bimbo



3175/R
mm 78
Tweezer straight
Pinzetta retta



3175/O
mm 78
Tweezer slant
Pinzetta obliqua



3162
mm 90
Nail scissors
Forbici per unghie



3163
mm 95
Nail scissors
Forbici per unghie



3188
mm 95
Nose scissors
Forbici per naso



3190
mm 98
Tweezer straight
Pinzetta retta



3191
mm 98
Tweezer slant
Pinzetta obliqua



3180
mm 140
Nail nipper
Tronchese per unghie



3182
mm 120
Nail nipper
Tronchese per unghie



3184
mm 100
Cuticle nipper
Tronchese per pellicine



3192
mm 150
Nail file
Limetta per unghie

100
mm 115

101
mm 165

Stork scissors
Forbici cicogna



Your hands are the best instruments in your practice. Take care of them with Medesy manicure set.

Le tue mani sono i più importanti strumenti per il tuo lavoro. Tienile curate con il set di manicure Medesy.



304/D

Gold plated, genuine leather
Dorato, astuccio in pelle



304/T

Nickel
Nichelato



New display case divided into 4 different sections (trays) which can be used to arrange instruments of various type. Each section (tray) has Velcro strips on the rear side and therefore the sections are interchangeable and you can combine the case according to each specific need. With this new system, you can remove from the case just and exactly the single tray you need.

Nuova valigetta, dispone di 4 singole sezioni (vassoi) che possono essere composte con strumenti assortiti. Ogni singola sezione (vassoio) ha delle strisce di velcro nella parte posteriore, rendendole intercambiabili e combinabili secondo preferenza.

Con questo nuovo sistema si possono comporre le valigette sulla base delle singole esigenze.



2918



Compose your own case!
Componi la tua valigetta!

2918/1

Elastics 10 pos.
Elastici 10 pos.



2918/2

Hand instruments 16 pos.
Strumenti manuali 16 pos.



2918/3

Extraction 6 pos.
Estrazione 6 pos.



New trolley, the optimal solution for exhibitions and presentations as it can contain a large number of instruments assorted in several trays. Available as an empty case or including a standard selection of Medesy instruments or even customized with your specific choice of products. On wheel casters the trolley can be easily transported.

Nuovo trolley per esposizioni e fiere di Medesy: un'ottima soluzione per portare numerosi strumenti in modo pratico e sicuro. Grazie alle rotelle in dotazione, il trolley si può trasportare agevolmente. Può essere fornito vuoto o in configurazione standard con articoli selezionati da Medesy o personalizzata su richiesta del cliente.



2915

2915 (With or without instruments)
2915 (Con o senza strumenti)



“ MEDESY IN SPOT
*Content can be changed
upon request*

*Su richiesta il contenuto
può essere cambiato* ”



ULTRASONIC CLEANER

VASCHE DI LAVAGGIO AD ULTRASUONI

7060

Specifications / Specifiche

Capacity / Capacità: 6 litre

Internal dimensions / Dimensioni interne: 300 × 230 × 100 (h) mm

Power ultrasonic / Potenza ultrasuoni: 200/400 W – 38 KHz

7120

Specifications / Specifiche

Capacity / Capacità: 12 litre

Internal dimensions / Dimensioni interne: 300 × 230 × 200 (h) mm

Power ultrasonic / Potenza ultrasuoni: 250/500 W – 38 KHz

ATTENTION!

- Check volts and plugs
 - Check standards required (CE-UL)
- before order!**



Our new ultrasonic baths are available in two tank sizes: 6 and 12 litres. Extremely compact and easily operated, these ultrasonic baths provide a high standard cleansing of surgical and dental instrumentation. Made of stainless steel this product stands out for its solidity and use safety. Equipped with microprocessor control for precision cleansing time and temperature controlled operation, the digital control panel displays accurately also power and frequency of the ultrasounds. Ultrasonic cleaning involves the use of high-frequency sound waves and is considered the most efficient system nowadays as it guarantees the full and accurate removal of all dirt residuals even inside the joints of the surgical instruments (such as needle-holders, pliers and scissors) and it reduces the risk of cutting injuries which may occur during manual cleansing. The optimal performance and longer duration of an instrument depends also on the adopted cleaning procedures.

Nuove vasche per lavaggio ad ultrasuoni, disponibili in 2 varianti: 6 o 12 litri. Estremamente compatte e facili da utilizzare, garantiscono il perfetto lavaggio dello strumentario chirurgico ed odontoiatrico. Sono prodotte in acciaio inossidabile e si contraddistinguono per solidità e sicurezza d'uso. Fornite di regolazione digitale della temperatura e dei tempi di lavaggio, sono dotate anche di display digitale dove si evidenzia la potenza e la frequenza degli ultrasuoni. Il lavaggio ad ultrasuoni è il sistema più efficace: garantisce infatti la pulizia anche all'interno degli snodi degli strumenti (come porta aghi, pinze e forbici) e riduce il rischio di tagli causati da una pulizia manuale. Un perfetto lavaggio contribuisce alla buona funzionalità e durata nel tempo degli strumenti.



PROTECT YOUR CAPITAL PROTEGGI IL TUO PATRIMONIO



PRESERVE AND ADD VALUE TO YOUR INVESTMENT ON MEDESYS

All MEDESYS instruments are manufactured only with high quality stainless steel and accurately checked during each manufacturing phase. Observance of the recommended cleaning, sterilization and lubrication practices will help to ensure the best product performance. Misuse, abuse, improper use or unsuitable care and poor maintenance will VOID WARRANTY claims.

PROTEGGI E VALORIZZA IL TUO INVESTIMENTO MEDESYS

Tutti gli strumenti MEDESYS sono realizzati solo con il migliore acciaio e accuratamente controllati durante tutte le fasi di produzione. È importante attenersi alle raccomandazioni per la sterilizzazione, pulizia e lubrificazione aiuterà a mantenere gli strumenti in perfetta efficienza! Tutti gli strumenti MEDESYS sono garantiti contro ogni difetto di materiale e/o produzione per l'intera vita utile dello strumento. La garanzia **NON È GARANTITA** in caso di: abuso, uso improprio degli strumenti e/o manutenzione inaccurata e sterilizzazione errata.

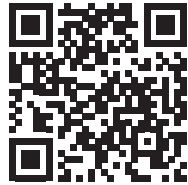

WATCH THE VIDEO ON
YouTube MEDESYS CHANNEL!

SUGGESTED DISINFECTION AND STERILIZATION PROCEDURES PROCEDURE DI DISINFEZIONE E STERILIZZAZIONE



Instruments must be separated according to the materials they are made of. Joined or hinged instruments must be opened before placing in the container. Gli strumenti vanno suddivisi per materiale. Eventuali strumenti con cerniere o snodi devono essere posti nel contenitore in posizione aperta.

1 COLLECTING THE INSTRUMENTS RACCOLTA DEGLI STRUMENTI



ATTENTION!



Instruments made of different materials (ex: stainless steel – titanium or aluminium) must be kept separated since each material reacts differently to chemical solutions. We advise to choose the correct cleansing product in relation to the instrument material.

Non maneggiare contemporaneamente strumentario di materiali diversi (es. acciaio Inox – alluminio – titanio): la loro reazione alle soluzioni chimiche utilizzate è diversa. Utilizzare prodotti specifici in base al materiale dello strumento.



Dilution; time of action.
Diluizione; tempo di immersione.



Disinfection bath or ultrasound bath. Make sure you are choosing the appropriate disinfectant depending on the instrument material and carefully follow the dilution percentages indicated on the solution labels. Do not disinfect Aluminium or Titanium instruments in ultrasonic baths.

In vasche di disinfezione o vasche ad ultrasuoni. Attenersi alle istruzioni indicate sul prodotto scelto rispettando le percentuali di diluizione e i tempi di immersione a seconda del materiale di cui è composto lo strumento. Non mettere gli strumenti in alluminio o in titanio nella vasca ad ultrasuoni.

2 DISINFECTION

DISINFEZIONE



The disinfected material must be rinsed thoroughly before washing.
Il materiale disinfettato deve essere sciacquato abbondantemente prima di procedere alla fase di lavaggio.

3 RISING

RISCIACQUO



The aim of washing is to remove organic and inorganic residues and micro-organisms. This can be done either manually or automatically in instrument washers or thermal disinfectors.

Il lavaggio rimuove residui organici, inorganici e microrganismi. Può avvenire in maniera manuale o automatica in lavastumenti o termodisinfettori.

4 WASHING

LAVAGGIO

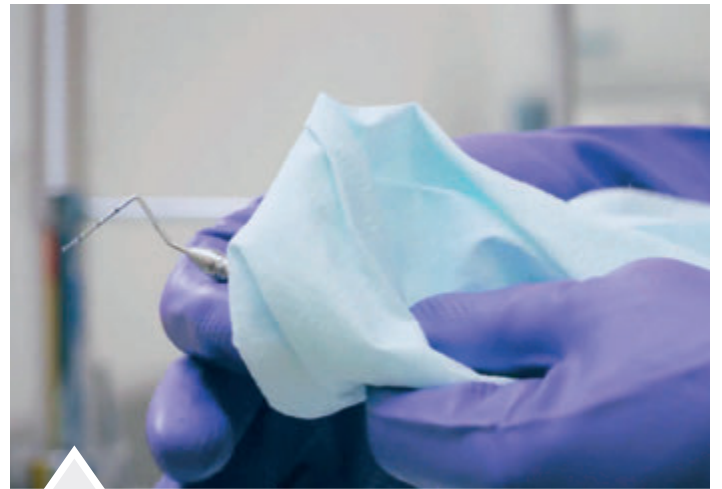

Moisture could compromise the outcome of sterilization and lead to the formation of marks on the surface of the instrument. Dry the instrument manually, preferably with a disposable cloth which does not leave fibers, or with compressed air.

L'umidità può compromettere l'esito della sterilizzazione e causare la formazione di macchie. Asciugare gli strumenti manualmente preferibilmente con panni monouso che non rilasciano fibre o con aria compressa.

5 DRYING

ASCIUGATURA



Apply specific lubricants. If the material is steam-sterilised, the products must be silicone free.

Applicare prodotti specifici lubrificanti a freddo.

6 MAINTENANCE MANUTENZIONE

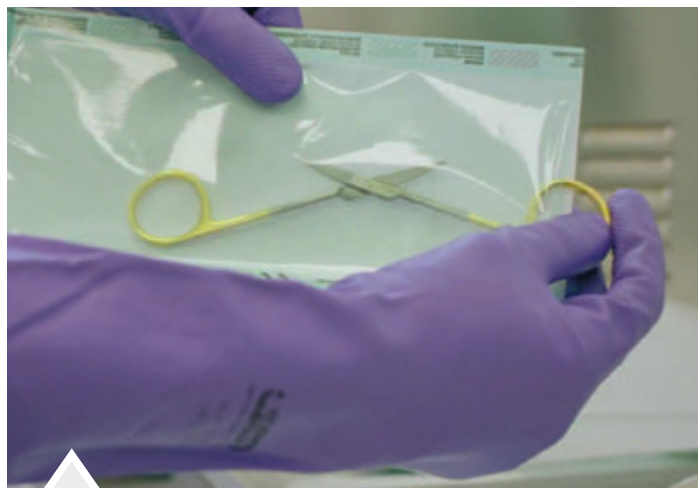

Sort the instruments into pouches. For each pouch, indicate the sterilisation and expiry date and the operator performing and verifying the process. All pouches must also have a chemical process indicator and sterilisation integrator.

Seguire il confezionamento degli strumenti indicando: data di sterilizzazione e di scadenza e l'operatore che ha eseguito e verificato il processo.

7 PACKING CONFEZIONAMENTO



Time; temperature; bar pressure.
Tempo; temperatura; pressione bar.



We suggest using a class B fractioned vacuum wet heat autoclave. We recommend sterilizing instruments at 134°C a 2.1 bars, or 121°C at 1.1 bars.

Si consiglia l'utilizzo di un autoclave a calore umido a vuoto frazionato di classe B, sterilizzando gli strumenti a 134°C a 2.1. bar, oppure 121°C a 1.1 bar.

8 STERILISING STERILIZZAZIONE



At the end of the process the pouches with sterile instruments must be kept in a dry dust-free, light and heat protected storage areas.

Le buste contenenti gli strumenti sterili vanno infine conservate al riparo da luci e fonti di calore, in ambienti asciutti e privi di polveri.

9 STORING CONSERVAZIONE



A			
Adams pliers	F7		
Aderer pliers	F8		
Adhesive remover	F15		
Adson needle holders	A89		
Adson tweezers	A115		
Albrecht tweezers	A8		
Alcohol burner	H16		
Alginat spatula	G7		
Allen periosteals	A51		
Allis forceps	A95		
Amalgam carriers	D26-D27		
Amalgam carvers	D21-D22		
Amalgam well	D27		
Anatomic elevators	A35		
Anglie pliers	F7		
Apexo elevators	A38		
Apical elevators	A31		
Arkansas stones	C23		
Arnhold forceps	E22		
Articulating forceps	G19		
Articulators	G11		
Austin retractors	A99		
B			
Backhaus forceps	A96		
Bad-Parker scalpel handle	A53		
Ball condensers	D20		
Ball scalers	C11		
Band pliers	F14		
Band pusher	F21		
Band seater	F21		
Bandage scissors	A78		
Barnhart currettes	C9		
Barraquer needle holder	A83		
Barraquer-Katzin tweezers	A117		
Baumgartner needle holders	A88		
BeeBee scissors	A79		
Beerendonk calipers	G20		
Bein elevators	A29		
Bennet condenser	D20		
Bennet periosteals	A48		
Bergh for crowns	D39		
Bertene elevators	A29		
Beyer bone rongeurs	A59		
Bishop-Harman tweezers	A117		
Black for enamel	D15		
Blade Beaks forceps	A22-A26		
Blade breaker	A55		
Blade remover	A55		
Blumental bone rongeurs	A58		
Bohm for crowns	D38		
Boley calipers	G20		
Bone aspirators	E15		
Bone chisels	E10-E11		
Bone collectors	E13		
Bone crusher	E12		
Bone currettes	A60-A61		
Bone files	A56-A57		
Bone graft forceps	E22		
Bone injectors	E13		
Bone mill	E12		
Bone pluggers	E14		
Bone rongeurs	A58-A59		
Bone scraper	E12		
Boynton needle holders	A86		
Braket instruments	F20		
Braket pliers	F14		
Bruenings retractors	A99		
Buck files	C19		
Buck knives	C18		
Buser sinus lift	E9		
C			
Calipers	E21, G20		
Castroviejo calipers	E21		
Castroviejo needle holders	A84-A85		
Castroviejo scissors	A80		
Cattoni scalers	C11		
Cement spatulas	G6		
Ceramic instr.	G8		
Cheatle forceps	H7		
Chompret syndesmotomes	A48		
Cl 2/3 scalers	C11		
Cinch Back pliers	F12		
Clamps	D31-D35		
Clamps forceps	D36		
Cleoids carvers	D23		
Cleveland bone rongeurs	A59		
College tweezers	B5		
Collins forceps	A96		
Columbia currettes	C8		
Comella forceps	A20		
Comella mirrors	B2		
Composite instruments	D2-D11		
Condensers	D17-D19		
Containers	H6		
Cook-Wait syringes	A108		
Cope retractors	A100		
Cotton dispenser	H15		
Coupland elevators	A35		
Cow Horn forceps	A12		
Crane-Kaplan knives	C18		
Crane-Kaplan scalers	C11		
Crile-Ryder needle holders	A88		
Crile-Wood needle holders	A90		
Crimping pliers	F15		
Crown & gold scissors	A79, F21		
Crown instruments	D38-D39		
Crown removers	D37		
Cryer elevators	A29, A32		
Cryer forceps	A9		
Cumine scalers	C14		
Cup dispenser	H15		
Currettes	C2-C10		
Currettes titanium	C17		
Cutters pliers	F4-F5		
D			
Dam	D30		
Dam forceps	D36		
Dam frame	D34		
Dappen dish	D27		
Darby-Perry scalers	C14		
De Bakey tweezers	A114		
De La Rosa pliers	F9		
De Marco currettes	C10		
Dean scissors	A68		
Debridement currettes	C10		
Derf needle holders	A90		
Desmarres retractors	A100		
Didner matrix retainers	D28		
Discloids carvers	D24		
Distals orthodontic	F2-F3		
Dressing forceps	A96		
Drums sterilization	H7		
E			
Eiselberg-Mathieu needle holder	A87		
Elastomers spatula	G7		
Enamel instruments	D15		
Endobox	D48-D49		
Endodontic plier	D46-D47		
Endodontic ruler	D51		
Endometer	D51		
Excavators	D12-D14		
Excavators endodontic	D45		
Exomed	A2		
Explorers	B6-B8		
Explorers endodontic	D44		
Extractor for fragments	A43		
F			
Fagbebstock knives	G4		
Farabeuf retractors	A98		
Fedi chisels	C20		
Flag tweezers	B5		
Flohr elevators	A29		
Flush distals	F3		
Foerster forceps	A96		
Frahm carvers	D22		
Frazier cannulas	A95		
Freer periosteals	A50		
Friedman bone rongeurs	A59		
Friedman elevators	A34		
Furrer for crowns	D38		
G			
Gammatrix trays	H2-H5		
Gerald tweezers	A113		
Gill-Hess tweezers	A117		
Gillies needle holders	A91		
Gingival cord packer	D25		
Glass mixing	D27		
Glick endodontic	D42		
Goldman-Fox currettes	C8		
Goldman-Fox hoes	C15		
Goldman-Fox knives	C18		
Goldman-Fox periosteals	A50		
Goldman-Fox probe	B10		
Goldman-Fox scalers	C13		
Goldman-Fox scissors	A68		
Goldstein composite	D2-D6		
Gracey currettes	C2-C7		
Gritmann knives	G4		
Gross Maier forceps	A96		
H			
Haemostatic forceps	A94		
Halsey needle holders	A89		
Halstead Mosquito forceps	A94		
Harris forceps	A9, A18		
Hartmann forceps	A94		
Heat carriers	D43		
Heidbrink elevators	A42		
Heidemann spatula	D4		
Heiss forceps	A94		
Hemingway bone currettes	A60		
Henahan retractors	A101		
Hirschfeld files	C19		
Hi-Tech scissors	A63-A65		
Hoes	C15		
Holder for mill e canal instr.	D50		
Hollenback carvers	D21		
Hollenback plastic filling	D16		
Hollow chop pliers	F11		
Hopkins periosteals	A48		
Hourigan elevators	A31		
Hourigan periosteals	A51		
How pliers	F6		
Howard elevators	A42		
Howard periosteals	A51		
Hygenist scalers	C12		
Hylin elevators	A34		
Hylin knives	G5		
I			
Impression trays	G12-G19		
India stones	C23		
Indiana currettes	C9		
Interproximal carvers	D21		
Iris scissors	A66		
Ivory matrix retainers	D28		
Iwanson calipers	G20		
J			
Jacobson scissors	A81		
Jaquette scalers	C13		
Jarabak pliers	F8		
Jeweler tweezers	A117		
Johnson pliers	F13		
Jones forceps	A96		
Joseph scissors	A69		
K			
Kelly forceps	A94		
Kelly scissors	A69		
Kelly-Rankin forceps	A94		
Kerrison bone rongeurs	A58		
Kilner scissors	A69		
Kirkland chisels	C21		
Kirkland knives	C18		
Kocher retractors	A102		
Kopp elevators	A36		
Kramer currettes	C10		
Kramer-Nevis sinus lift	E8		
L			
La Grange scissors	A68		
Ladmore forceps	A16		
Ladmore plastic filling	D18		
Langenbeck retractors	A102		
Langer currettes	C8		
Le Cron knives	G5		
Left-handed scissors	A76		

Lempert bone rongeurs	A59	Orban hoes	C15	Suction tubes	A95
Lessmann knives	G4	Orban knives	C18	Sugarman files	C19
Ligature forceps	F16-F17	Oringer gags	A97	Superior cut scissors	A72
Ligature instruments	F18-F19	Osteotomes	E2-E6	Suture scissors	A78
Lindo-Levian elevators	A40			Suture tweezers	A93
Locklin scissors	A68	P		Swedish needle holders	A90
London Hospital elevators	A35	Parmly forceps	A18	Swiss scalars	C13
Lorna forceps	A95	Partsch chisels	E11	Syndesmotomes	A48
Lucas bone curettes	A61	Partsch mallets	E7	Syringes	A106-A111
Luer bone rongeurs	A58	Peet plier	D47	Syringes for elastomers	G13
Luks pluggers	D42	Periodontal chisels	C20		
Luniatscheck packers	A95	Periodontal files	C19	T	
Lussatore elevators	A39	Periodontal knives	C18	Tanner plastic filling	D16
		Periodontal probes	B9-B12	Taylor scalars	C11
M		Periosteals elevators	A50-A51	Taylor tweezers	A112
Malleable retractors	A101	Periotome	A52	TC scissors	A74
Mallets	E7, G10	Perry tweezers	B5	TC tweezers	A115
Manicure instruments	H18-H19	Physick forceps	A19	TG chisels	C21
Marilyn scissors	A67	Pin holding tweezer	D47	Tissue nipper	A78
Markley plastic filling	D16	Pins and nerve forceps	A15	Tofflemire matrix retainers	D28
Mathieu for ligature	F16	Pins e abutment tweezers	E16	Tomes forceps	A9
Mathieu needle holders	A86-A87	PK Thomas	G2-G3	Tongue forceps	A96
Mathieu-Olsen neendle holders	A91	Placement instruments	D19	Tooth forceps	A4-A27
Matrix bands	D29	Plaster shears	G10	Tooth forceps pedo	A4-A9
Matrix retainers	D28	Plaster spatulas	G7	Towel forceps	A96
Mayo scissors	A71	Plastic-Filling instruments	D16-D20	Towner scalars	C12
Mayo table	H17	Pliers holder	F24	Trays aluminium	H12
Mayo-Hegar needle holders	A89	Pluggers endodontic	D40-D42	Trays polysulfone	H8-H9
McCall curettes	C9	Pott elevators	A37	Trays universal	H10 -H11
McCall scalars	C13	Prichard periosteals	A51	Trephines	E20
Me-1 curettes	C9	Protesis carrier	H16	Trolley	H21
Mead mallets	E7			Tucker for ligature	F18
Mead periosteals	A51	R		Tweed pliers	F8-F10
Medan-Bein elevators	A34	Rack for trays	H11	Tweezers	A112-A117
Medan-Cryer elevators	A34	Ragnell-Davis retractors	A100	Tweezers dressing	B5
Medan-Flohr elevators	A34	Retractors	A98-A103		
Medimpla elevators	A45	Reynolds pliers	F13	U	
Membrane instr.	E16	Rhodes chisels	C20	Ultrasonic cleaner	H22
Mercury probes	B10	Ring Lock scissors	A77	USC carvers	D22
Meriam tweezers	B5	Rochester-Kocher forceps	A94	USC Towner knives	C18
Merrit probes	B10	Rochester-Pean forceps	A94	Utility pliers	F6
Metzenbaum scissors	A70	Romerowski condenser	D20		
Michigan probes	B10	Root elevators	A28-A47	V	
Micro Cooley tweezers	A114	Roser-Konig gags	A97	Vestibulum retractors	A99
Middeldorp retractors	A102	Routurier forceps	A16	Volkman bone curettes	A60
Midelux elevators	A44	Rowe forceps	E22	V-Stop plier	F13
Miller bone curettes	A61	Rowney forceps	A12		
Miller bone files	A56-A57	Ruler	G20	W	
Miller elevators	A31	Russian tweezers	A115	W. Barry elevators	A33
Miller forceps	G19			Wahl bone files	A56
Minnesota retractors	A98	S		Wakefield chisels	E10
Mirrors	B2-B3	Saliva ejectors	H16	Ward carvers	D21
Mirrors handles	B4	Sanders knives	C18	Warwick-James elevators	A37
Miscellaneous cups	H14	Saws	G10	Wassmund retractors	A102
Mish retractors	A101	Scalars	C11-C14	Waste container	H15
Mitchel scalars	C14	Scalars titanium	C17	Wax & modelling instr.	G2-G3
Mixing bowls	H14	Scalpel handles	A53-A55	Wax knives	G4-G5
Mixing glass	H14	Scalpels	A53-A55	Wedelstaedt chisels	D22
Modelling knives	G13	Scalpels micro	A55	Weingart pliers	F6
Molt gags	A97	Schluger files	C19	Westcott composite	D7, D20
Molt periosteals	A50	Schmeckebier elevators	A31	White condenser	D20
Montfort for crowns	D39	Schwarz pliers	F9, F13	Wieder retractors	A99
Morse scalars	C13	Scissors	A62-A81	Wiland carvers	D22
Mouth gags	A97	Seizing and sterilizing forceps	H7	Williams probe	B10
Mucotomes	E20	Seldin elevators	A31-A32	Williger bone curettes	A60
		Seldin periosteals	A48	Williger periosteals	A48
N		Semken tweezers	A113	Williger scalars	C14
Nabers probes	B11	Senn-Miller retractors	A100	Winter elevators	A33
Nance pliers	F12	Sharpening oil	C23	Wire bending pliers	F7-F13
Napkin holders	H16	Sharpening stones	C23	Wire scissors	A79, F21
Nebraska scalars	C14	Sharpening testers	C22	Witzel forceps	A16
Needle holders	A82-A93	Shoshan carvers	D22	Wood forceps	A12
Neumann scissors	A68	Sickle scissors	A66	Woodson composite	D5
Nevius forceps	A18	Sinus lift instr.	E8-E9	Wynman for crowns	D38
Noyes scissors	A80	Siqueland matrix retainers	D28		
Nystrom carvers	D21	Smaha forceps	F16	Y	
Nystrom matrix retainers	D28	Soldering forceps	G19	Young forceps	A96
		Spreaders endodontic	D41	Young pliers	F10
O		Sprengel carvers	D22	Younger-Good curettes	C9
Obwegeser retractors	A101-A103	Square-Ring scissors	A67		
Occluder	G11	Standard scissors	A71	Z	
Ochsenbein chisels	C20, E10	Steiner for ligature	F17	Zahle knives	G5
Oil lubricant	F11, H17	Step plier	F13	Zed scissors	A73
Olsen-Hegar needle holders	A92	Sternberg retractors	A99	Zerfing chisels	C21
Optical pliers	F11	Stieglitz forceps	A15	Zuricher calipers	G20

Medan-Flohr leve	A34
Medimpla leve	A45
Mercury sonda	B10
Meriam pinzette	B5
Merrit sonda	B10
Metzenbaum forbici	A70
Michigan sonda	B10
Micro Cooley pinzette	A114
Middeldorp divaricatori	A102
Midelux leve	A44
Miller cucchiaini alveolari	A61
Miller leve	A31
Miller lime per osso	A56-A57
Minnesota divaricatori	A98
Mish divaricatori	A101
Mitchell scalers	C14
Molt apribocca	A97
Molt scollaperiosteo	A50-A51
Montfort per corone	D37
Morse scalers	C13
Mortain per amalgama	D27
Mortain per osso	E12
Mucotomi	E20

N	
Nabers sonda	B11
Nance pinze	F12
Nebraska scalers	C14
Neumann forbici	A68
Nevius pinze estrazione	A18
Nistrom per amalgama	D21
Noyes forbici	A80
Nystrom portamatrici	D28

O	
Obwegeser divaricatori	A101-A103
Occlusore	G11
Ochsenbein scalpelli	C20, E10
Olio lubrificante	F11, H17
Olio per pietre	C23
Olsen-Hegar porta aghi	A92
Optical pinze	F11
Orban bisturi	C18
Orban scalpelli	C15
Oringer apribocca	A97
Osteotomi	E2-E6
Otturatori	D16-D20

P	
Parmly pinze	A18
Partsch martelli	E7
Partsch scalpelli	E11
Peet endodontiche	D47
Periotomo	A52
Perry pinzette	B5
Physick pinze	A19
Pietre per affilare	C23
Pinza macina osso	E12
Pinza rompi lama	A55
Pinze cogli strumenti	H7
Pinze emostatiche	A94-A95
Pinze endodontiche	D46-D47
Pinze ossivore	A58-A59
Pinze per articolazione	G19
Pinze per attacchi	F20
Pinze per elastici	F17
Pinze per estrazione	A4-A27
Pinze per estrazione Albrecht	A8
Pinze per estrazione Pedro	A5-A9
Pinze per frammenti Stieglitz	A14
Pinze per legature	F16
Pinze per tamponi	A96
Pinze per teli	A96
Pinze per uncini	D36
Pinze piega fili ortodontiche	F7-F13
Pinze tiralingua	A96
Pinze togli adesivo	F15
Pinze togli bande	F14
Pinze togli braket	F14
Pinze togli lama	A55
Pinze trattieni osso	E22
Pinze utilità ortodontiche	F6
Pinzette	A112-A117
Pinzette per medicazione	B5
Pinzette per pins	E16

Pinzette per saldature	G19
PK Thomas	G2-G3
Pluggger endodontici	D40, D42
Porta aghi	A82-A92
Porta frese	D50
Portaimpronte	G12-G19
Portamatrici	D28
Portaprotesi	H16
Portatamponi	A95
Pott leve	A37
Potts Smith pinzette	A115
Prichard scollaperiosteo	A51

R	
Ragnell-Davis divaricatori	A100
Rastrelliere porta pinze	F24
Renette	H10
Reynolds pinze	F13
Ring Lock forbici	A77
Rochester-Kocher pinze emostatiche	A94
Rochester-Pean pinze emostatiche	A94
Romerowski otturatori	D20
Roser-Konig apribocca	A97
Routurier pinze	A16
Rowe pinze	E22
Rowney pinza per estrazione	A12
Russian pinzette	A115

S	
Sanders bisturi	C18
Scalers	C11-C14
Scalpelli chirurgici	C20
Scalpelli parodontali	C15
Scalpelli per osso	E10-E11
Schluger lime	C19
Schmeckeber leve	A31
Schwarz pinze	F9, F13
Scollaperiostei	A50-A51
Seghetti	G10
Seldin leve	A29, A32
Seldin scollaperiostei	A48
Semken pinzette	A113
Senn-Miller divaricatori	A100
Shoshan per amalgama	D22
Sickle forbici	A66
Silicone anelli	C14
Sindesmotomi	A48-A49
Siqueland portamatrici	D28
Siringhe	A106-A111
Siringhe per elastomeri	G13
Smaha per legature	F16
Sonda parodontali	B9-B12
Spatole per alginato	G7
Spatole per cementi	G6
Spatole per elastomeri	G7
Specchiotti	B2-B3
Specilli	B6-B8
Specilli endodontici	D44
Spencer forbici	A78
Spingi amalgama	D26-D27
Splinter pinze	A15
Spreader endodontici	D39
Sprengel per amalgama	D22
Square ring forbici	A67
Standard forbici	A71
Stecca endodontica	D51
Steiner per legature	F17
Step pinza	F13
Sternberg divaricatori	A99
Stieglitz pinza	A15
Strumenti ausiliari ortodontici	F18-F19
Strumenti canalari	D43
Strumenti di riporto	D19
Strumenti in titanio	E17
Strumenti per attacchi	F20
Strumenti per bande	F21
Strumenti per ceramica	G8
Strumenti per composito	D2-D11
Strumenti per corone	D38-D39
Strumenti per filo retrattore	D25
Strumenti per il rialzo del seno	E8-E9
Strumenti per membrane	F16
Strumenti per modellare	D16-D20
Strumenti taglia smalto-dentina	D15
Sugarmann lime	C19

Superior cut forbici	A72-A73
Suture pinzette	A93
Swedish porta aghi	A90
Swiss scaler	C13

T	
Tanner otturatori	D16
Taylor pinzette	A112
Taylor scalers	C11
Tazze per alginato	H14
Tazze per amalgama	D27
TC forbici	A74-A75
Telaio per diga	D34
Tessier divaricatori	A101
TG scalpelli	C21
Thorne pinza per estrazione	A14
Titanio currettes	C16
Titanio scalers	C17
Tofflemire portamatrici	D28
Tomes pinza per estrazione	A9
Towner scalers	C12
Trephines	E20
Tronchese per lembi	A78
Tronchesi ortodontici	F4-F5
Tucker per legature	F18
Tweed pinze	F8-F10

U	
Uncini per diga	D31-D35
USC per amalgama	D22
USC tonner bisturi	C18

V	
Vasca ultrasuoni	H22
Vassoi in alluminio	H12-H13
Vassoi in polysulfone	H8
Vassoi universali	H10
Vestibulum divaricatori	A99
Vetro per impasti	D27
Volkman cucchiaini alveolari	A60

W	
Wahl lime per osso	A56
Wakefield scalpelli	E10
Ward per amalgama	D21
Warwick-James leve	A37
Washington pinze uncini	D36
Wassmund divaricatori	A102
Wedelstaedt	D22
Weingart pinze	F6
Westcott strumento composito	D7, D20
White leve	A29
White otturatori	D20
White pinze uncini	D36
Wieder divaricatori	A99
Wiland per amalgama	D22
Williams sonda	B10
Williger cucchiaini alveolari	A60
Williger scalers	C14
Williger scollaperiostei	A48
Winter leve	A33
Witzel pinze	A16
Wood pinza per estrazione	A12
Woodson spatole	D5
Wynman per corone	D38

Y	
Young pinze	F10
Young tiralingua	A96
Younger-Good currettes	C9

Z	
Zahle per cera	G5
Zed forbici	A73
Zerfing scalpelli	C21
Zuricher calibri	G20

100	H19	492/1T	D6	540/1	D42	560/1.HL8	B8	599/2	G4
101	H19	492/2	D2	540/2	D42	560/2	B8	599/3	G4
115	G7	492/2T	D6	540/3	D42	560/2.HL8	B8	599/4	G4
116	G7	492/3	D2	540/4	D42	560/3	B8	599/5	G4
117	G6	492/3T	D6	542/1.C6	D40	560/3.HL8	B8	599/KIT	G4
118	G6	492/4	D2	542/2.C6	D40	560/4	B8	600/1	D21
119	G6	492/4T	D6	542/3.C6	D40	560/4.HL8	B8	600/2	D21
150	H4	492/11	D2	542/4.C6	D40	560/5-6	B8	600/3	D21
150/V	H4	492/11T	D6	542/5.C6	D40	560/5-6.HL8	B8	601/2	D21
151	H4	492/14	D2	542/6.C6	D40	560/17-3A	B8	601/3	D21
151/V	H4	492/14T	D6	542/7.C6	D40	560/17-3A.HL8	B8	601/4	D21
152	H4	494/1	D5	542/KIT	D40	563/1	B11	602	D22
152/V	H4	494/1T	D8	543/1.C6	D41	563/2	B11	602/1	D22
153	H4	494/2	D5	543/2.C6	D41	563/3	B11	603	D22
153/V	H4	494/2T	D8	543/3.C6	D41	565/1	D44	604/1	D21
154	H4	494/3	D5	543/4.C6	D41	565/2	D44	604/2	D21
154/V	H4	494/3T	D8	543/5.C6	D41	565/3	D44	605/1	D22
155	H4	497/1	D5	543/KIT	D41	566/16	B12	605/3	D22
155/V	H4	497/1T	D8	544/1-3	D42	566/17	B12	605/4	D22
156	H4	497/2	D5	544/5-7	D42	566/23	B12	605/8	D22
156/V	H4	497/2T	D8	544/9-11	D42	567/3	B12	607	D22
201	G4	497/3	D5	545/1	D42	567/16	B12	608/0	D23
202	G4	497/3T	D8	546/1	B10	567/17	B12	608/1	D23
203	G4	499/1T	D7	546/2	B10	567/23	B12	608/2	D23
204	G4	499/9T	D7	546/3	B10	568/1	B11	608/3	D23
205	G4	499/20T	D7	546/4	B10	569/1	B11	608/4	D23
206	G4	499/KIT	D7	546/5	B10	569/2	B11	608/5	D23
208	G7	500/0	D19	546/6	B10	569/2 COL	B11	609/1	D15
209	G7	500/1	D19	546/7	B10	570/1	B12	609/2	D15
210	G7	500/1T	D9	547/4	B10	570/2	B12	609/3	D15
211	G7	500/2	D19	547/4 PT	B10	570/3	B12	609/4	D15
213	G7	500/2T	D9	548/1	B9	570/4	B12	609/5	D15
213/2	G7	500/3	D19	548/1 PT	B9	570/5	B12	609/6	D15
214	G4	500/3T	D9	548/2	B9	571/16	B12	609/7	D15
215/1	H14	500/4	D19	548/2 PT	B9	571/23	B12	609/8	D15
215/2	H14	500/5	D19	548/3	B9	574	G13	609/9	D15
215/3	H14	502/1	D19	548/3 PT	B9	575/1	G8	610	G5
216/A	D27	502/2	D19	548/4	B9	575/2	G8	610/1	D21
216/B	D27	507/6	D3	548/4 PT	A119, B9	575/3	G8	610/2	D21
216/V	D27	507/6T	D8	548/5	B9	576/1	G8	610/3	D21
220	H16	507/11	D3	548/5 PT	B9	576/2	G8	611/243	D14
221	G19	507/11T	D8	548/6	B9	576/3	G8	611/244	D14
222	G19	507/179	D3	548/6 PT	B9	577/1-2-3	G8	611/245	D14
304/D	H19	507/179T	D8	548/7FI	B10	577/4-5-6	G8	612/26	D15
304/T	H19	509/10	D3	550/6-7.HL8	C15	578/1	D4	612/27	D15
466/1	D16	509/10T	D8	550/8-9.HL8	C15	578/2	D4	612/28	D15
466/2	D16	509/11	D3	551/1.HL8	C15	578/3	D4	612/29	D15
466/3	D16	509/11T	D8	551/3.HL8	C15	579/1	D4	613/78	D15
466/4	D16	509/12	D3	551/5.HL8	C15	579/2	D4	613/80	D15
470/0	D16	509/12T	D8	555/2	B6	579/3	D4	614/52	D15
470/1	D16	509/13	D3	555/2.HL8	B6	580/1	D4	614/54	D15
470/2	D16	518/1	D3	555/3	B6	580/2	D4	615/1	D15
470/3	D16	518/2	D3	555/3A	B6	580/3	D4	615/2	D15
472/2	D20	518/3	D3	555/3A.HL8	B6	581/1	G3	616/2	D22
473/1	D5	521/1	D20	555/3.HL8	B6	581/2	G3	616/4	D22
473/2	D5	521/1T	D7	555/5	B6	581/3	G3	616/6	D22
473/3	D5	521/2	D20	555/5.HL8	B6	581/4	G3	619/1	A95
474/2	D18	521/3	D20	555/6	B6	581/5	G3	619/2	A95
474/3	D18	523/1	D18	555/6.HL8	B6	582	D19	620/1.HL8	C10
475/15	D20	523/1Z	D18	555/8	B6	583/1	G2	620/2.HL8	C10
475/16	D20	523/2	D18	555/8A	B6	583/2	G2	620/3.HL8	C10
475/18	D20	523/2Z	D18	555/8A.HL8	B6	583/3	G2	621/128.HL8	C14
475/18T	D9	523/3	D18	555/8.HL8	B6	583/4	G2	622/1-2.HL8	C10
475/28	D20	523/3Z	D18	555/9	B6	583/5	G2	622/3-4.HL8	C10
475/28T	D9	527/0	D17	555/9.HL8	B6	584	D19	622/5-6.HL8	C10
475/29	D20	527/0Z	D17	555/10	B6	585	D25	622/7-8.HL8	C10
475/30	D20	527/1	D17	555/10.HL8	B6	585/4-L	D25	623/1.HL8	C9
477/32	D20	527/1Z	D17	555/11	B6	585/81	D25	623/5.HL8	C9
477/33	D20	527/2	D17	555/11.HL8	B6	585/81-L	D25	623/412.HL8	C8
478	D20	527/2Z	D17	555/12	B6	585/MSY	D25	623/414.HL8	C8
479/29	D20	527/3	D17	555/12.HL8	B6	585/MSY-L	D25	624/00.HL8	C13
484/1	D5	527/3Z	D17	555/16	B6	586/1	D20	624/1.HL8	C13
484/2	D5	527/4	D17	555/16.HL8	B6	587	D19	624/2.HL8	C8
485/1	D5	527/4Z	D17	555/17	B6	588	G5	624/3.HL8	C8
485/2	D5	530/1	D18	555/17A	B6	589	G5	624/4.HL8	C8
488/1	D16	530/2	D18	555/17A.HL8	B6	590	G5	624/5.HL8	C15
488/2	D16	530/3	D18	555/17.HL8	B6	591	G5	624/6.HL8	C15
488/3	D16	538/1	D42	555/23	B6	592	G5	624/21.HL8	C13
488/4	D16	538/2	D42	555/23.HL8	B6	593	G5	625/1-2.AL	C4
488/5	D16	539/1	D43	556/2	B7	594	G5	625/1-2.C8	C4
488/6	D16	539/2	D43	556/6	B7	595	G5	625/1-2.HL8	C4
490/PF1A	D3	539/3	D43	556/8A	B7	596	G5	625/1-2.HL10	C4
490/PF1AT	D7	539/4	D43	556/9	B7	597	G5	625/3-4.AL	C4
491/PF1	D3	539/5	D43	556/11-12	B8	598	G5	625/3-4.C8	C4
491/PF1T	D7	539/6	D43	556/23	B7	599	G5	625/3-4.HL8	C4
492/1	D2	539/7	D43	560/1	B8	599/1	G4	625/3-4.HL10	C4

625/5-6.AL	C4	640/1.HL8	C11	660/1.HL8	A60	670/1.HL8	D13	680/9	A29
625/5-6.C8	C4	640/1Ti.HL8	C17, E19	660/1.HL10	A60	670/2	D13	680/11	A29
625/5-6.HL8	C4	640/1Ti.HL10	C17, E19	660/2	A60	670/2.HL8	D13	680/12	A29
625/5-6.HL10	C4	640/2.HL8	C11	660/2.HL8	A60	670/3	D13	680/13	A29
625/7-8.AL	C4	640/3.HL8	C11	660/2.HL10	A60	670/3.HL8	D13	680/14	A29
625/7-8.C8	C4	640/5.HL8	C11	660/3	A60	670/4	D13	680/SET	A47
625/7-8.HL8	C4	640/5Ti.HL8	C17, E19	660/3.HL8	A60	670/4.HL8	D13	682/SET	A47
625/7-8.HL10	C4	640/5Ti.HL10	C17, E19	660/3.HL10	A60	670/KIT	D13	684/SET	A46
625/9-10.AL	C4	640/6.HL8	C11	660/4	A60	671/1	D13	686/SET	A46
625/9-10.C8	C4	640/7.HL8	C11	660/4.HL8	A60	671/2	D13	690/3	A29
625/9-10.HL8	C4	640/13.HL8	C11	660/4.HL10	A60	671/125-126	D14	690/4	A29
625/9-10.HL10	C4	640/23.HL8	C11	660/9	A61	671/127-128	D14	690/5	A29
625/11-12.AL	C4	640/24.HL8	C11	660/9.HL8	A61	671/129-130	D14	690/6	A29
625/11-12.C8	C4	640/107.HL8	C11	660/10	A61	671/131-132	D14	690/7	A29
625/11-12.HL8	C4	641/1	E10	660/10.HL8	A61	671/133-134	D14	690/8	A29
625/11-12.HL10	C4	641/2	E10	661/84	A61	671/153-154	D14	700/1	A37
625/13-14.AL	C4	641/3	C21	661/84.HL8	A61	671/155-156	D14	700/2	A37
625/13-14.C8	C4	641/3.HL8	C21	661/84.HL10	A61	672/0	F18	700/3	A37
625/13-14.HL8	C4	642/1	C20	661/85	A61	672/0.HL8	F18	700/8	A42
625/13-14.HL10	C4	642/1.HL8	C20	661/85.HL8	A61	672/0.HL10	F18	700/9	A42
625/15-16.AL	C4	642/2	C20	661/85.HL10	A61	672/1	F18	700/10	A42
625/15-16.C8	C4	642/2.HL8	C20	661/86	A61	672/1.HL8	F18	700/11	A42
625/15-16.HL8	C4	642/3	C20	661/86.HL8	A61	672/1.HL10	F18	700/12	A42
625/15-16.HL10	C4	642/3.HL8	C20	661/86.HL10	A61	672/2	F18	700/13	A42
625/KIT.AL	C4	643/3	C20	661/87	A61	672/2.HL8	F18	705/1	A42
625/KIT.C8	C4	643/3.HL8	C20	661/87.HL8	A61	672/2.HL10	F18	705/2	A42
625/KIT.HL8	C4	643/13.HL8	C20	661/87.HL10	A61	672/3	D14	705/3	A42
625/KIT.HL10	C4	643/14.HL8	C20	661/88	A61	672/4	D14	705/4	A42
626/2.HL8	C8	643/37	C20	661/88.HL8	A61	672/5	D14	705/6	A42
626/2Ti.HL8	C16, E18	643/37.HL8	C20	661/88.HL10	A61	672/10	F18	705/7	A42
626/2Ti.HL10	C16, E18	645/1	C18	663/17	D12	672/10.HL8	F18	705/8	A42
626/4.HL8	C8	645/2	C18	663/18	D12	672/10.HL10	F18	705/9	A42
626/6.HL8	C8	645/3	C21	663/19	D12	673	F19	720/1	A31
627/2.HL8	C8	645/3.HL8	C21	664/14	D12	673/1	F19	720/2	A31
627/4.HL8	C8	646/3.HL8	C18	664/17	D12	673/1.HL8	F19	720/3	A31
627/4Ti.HL8	C16, E18	647/1	C18	664/18	D12	673/1.HL10	F19	720/4	A31
627/4Ti.HL10	C16, E18	647/2	C18	664/19	D12	673/2C	F19	720/5	A31
627/14.HL8	C8	648/3.HL8	C18	665/11	D45	673/2C.HL8	F19	720/6	A31
628/1-2.C8	C5	649/3-7	C19	665/12	D45	673/2C.HL10	F19	720/7	A31
628/1-2.HL8	C5	649/3-7.HL8	C19	665/13	D45	673.HL8	F19	720/8	A31
628/1-2.HL10	C5	649/5-11	C19	665/21	D45	673.HL10	F19	720/9	A31
628/3-4.C8	C5	649/5-11.HL8	C19	665/22	D45	674	F19	720/10	A31
628/3-4.HL8	C5	649/9-10	C19	665/23	D45	674.HL8	F19	720/11	A31
628/3-4.HL10	C5	649/9-10.HL8	C19	665/31	D12	674.HL10	F19	720/15	A31
628/5-6.C8	C5	650/2	C19	665/32	D12	675/00	G6	720/20	A31
628/5-6.HL8	C5	650/2.HL8	C19	665/33	D12	675/1	G6	720/21	A32
628/5-6.HL10	C5	650/4	C19	668/39	D12	675/2	G6	720/22	A32
628/7-8.C8	C5	650/4.HL8	C19	668/64	D12	675/3	G6	720/23	A32
628/7-8.HL8	C5	650/10	C19	668/66	D12	675/4	G6	720/24	A32
628/7-8.HL10	C5	650/10.HL8	C19	669/1-2.C8	C6	675/MBC	E13	720/25	A32
628/9-10.C8	C5	650/12	C19	669/1-2.HL8	C6	676/1	G6	720/25S	A32
628/9-10.HL8	C5	650/12.HL8	C19	669/1-2.HL10	C6	676/24	G6	720/26	A32
628/9-10.HL10	C5	651/8.HL8	C12	669/1-2Ti.HL8	C16, E18	677/1	G6	720/26S	A32
628/11-12.C8	C5	651/9.HL8	C12	669/1-2Ti.HL10	C16, E18	678/3	G6	720/27	A32
628/11-12.HL8	C5	651/11.HL8	C12	669/3-4.C8	C6	679/1-2.C8	C7	720/27S	A32
628/11-12.HL10	C5	651/11Ti.HL8	C17, E19	669/3-4.HL8	C6	679/1-2.HL8	C7	720/28	A32
628/13-14.C8	C5	651/11Ti.HL10	C17, E19	669/3-4.HL10	C6	679/1-2.HL10	C7	720/28S	A32
628/13-14.HL8	C5	651/12.HL8	C12	669/5-6.C8	C6	679/3-4.C8	C7	720/29	A31
628/13-14.HL10	C5	651/30-33.HL8	C13	669/5-6.HL8	C6	679/3-4.HL8	C7	720/30	A31
628/KIT.C8	C5	651/31-32.HL8	C13	669/5-6.HL10	C6	679/3-4.HL10	C7	720/31	A31
628/KIT.HL8	C5	651/34-35.HL8	C13	669/5-6Ti.HL8	C16, E18	679/5-6.C8	C7	720/32	A31
628/KIT.HL10	C5	651/37-38.HL8	C13	669/5-6Ti.HL10	C16, E18	679/5-6.HL8	C7	725/1	A40
629/12.HL8	C13	651/H5-30.HL8	C12	669/7-8.C8	C6	679/5-6.HL10	C7	725/2	A40
629/13.HL8	C13	651/H5-33.HL8	C12	669/7-8.HL8	C6	679/7-8.C8	C7	725/3	A40
629/14.HL8	C9	651/U15-30.HL8	C12	669/7-8.HL10	C6	679/7-8.HL8	C7	725/4	A40
629/15.HL8	C9	651/U15-33.HL8	C12	669/7-8Ti.HL8	C16, E18	679/7-8.HL10	C7	725/5	A40
629/17.HL8	C9	652/50	C14	669/7-8Ti.HL10	C16, E18	679/9-10.C8	C7	725/6	A40
629/19.HL8	C9	653/1	C14	669/9-10.C8	C6	679/9-10.HL8	C7	725/SET	A40
629/20.HL8	C9	653/11	C14	669/9-10.HL8	C6	679/9-10.HL10	C7	726/1C	A30
630/1	C21	653/12	C14	669/9-10.HL10	C6	679/11-12.C8	C7	726/1S	A30
632/1.HL8	C10	653/U15.HL8	C12	669/11-12.C8	C6	679/11-12.HL8	C7	726/2C	A30
632/2.HL8	C10	654	C14	669/11-12.HL8	C6	679/11-12.HL10	C7	726/2S	A30
633/8.HL8	C9	655	C14	669/11-12.HL10	C6	679/13-14.C8	C7	726/3C	A30
633/17.HL8	C9	656/1.HL8	C9	669/11-12Ti.HL8	C16, E18	679/13-14.HL8	C7	726/3S	A30
634/7.HL8	C18	657/0	A60	669/11-12Ti.HL10	C16, E18	679/13-14.HL10	C7	726/4C	A30
634/8.HL8	C18	657/1	A60	669/13-14.C8	C6	679/KIT.C8	C7	726/4S	A30
634/9.HL8	C18	657/2	A60	669/13-14.HL8	C6	679/KIT.HL8	C7	726/5C	A30
634/11.HL8	C18	657/3	A60	669/13-14.HL10	C6	679/KIT.HL10	C7	726/5S	A30
635/4.HL8	C18	658	A60	669/13-14Ti.HL8	C16, E18	680/1	A29	726/6C	A30
635/6.HL8	C18	658/0	A60	669/13-14Ti.HL10	C16, E18	680/2	A29	726/6S	A30
636/2.HL8	C18	658/1	A60	669/KIT.C8	C6	680/3	A29	726/SET	A30
636/5.HL8	C18	658/2	A60	669/KIT.HL8	C6	680/4	A29	727/50	A41
637/20.HL8	C18	660/0	A60	669/KIT.HL10	C6	680/5	A29	728/1	A34
638/3.HL8	C18	660/0.HL8	A60	670/0	D13	680/6	A29	728/2	A34
639/23.HL8	C13	660/0.HL10	A60	670/0.HL8	D13	680/7	A29	730/3C	A39
639/24.HL8	C13	660/1	A60	670/1	D13	680/8	A29	730/3S	A39

730/4C	A39	826/B	A97	907/P	A98, A119	965/2	D50	998/AS	H13
730/4S	A39	826/G	A97	907/Z	A98	965/3	D50	998/B	H12
730/5C	A39	850	A51	908/1	A99	965/4	D50	998/BS	H13
730/5S	A39	851/HP3	A50, A119	908/2	A99	966/1	D50	998/D	H12
730/301	A38	851/HP3 Ti	A50, C28	909/1	A99	966/2	D50	998/DS	H13
730/302	A38	852/HP3	A50	909/2	A99	966/3	D50	998/FA	H12
730/302CB	A38	854/H02	A50	910/1	A95	966/4	D50	998/FAS	H13
730/303	A38	854/H02 Ti	A50	910/3	A95	967/1	D50	998/FB	H12
730/303CB	A38	856	A50, A119	910/4	A95	967/2	D50	998/FBS	H13
730/304W	A38	868/1	A52	910/5	A95	967/3	D50	998/FD	H12
730/SET	A39	868/2	A52	911/2	A95	974/B	H15	998/FDS	H13
735/SET	A38	868/3	A52	911/3	A95	974/D	H15	998/FR	H12
740/1	A35	868/4	A52	911/4	A95	974/G	H15	998/FRS	H13
740/2	A35	868/KIT	A52	911/5	A95	974/R	H15	998/FV	H12
740/3	A35	869	A51	912/1	A95	974/V	H15	998/FVS	H13
740/4	A35	870	A51	912/2	A95	975/B	H15	998/R	H12
740/5	A35	871/2-4	A50	912/3	A95	975/D	H15	998/RS	H13
750/1	A37	871/2-4 Ti	A50, C28	913	A98	975/G	H15	998/V	H12
750/2	A37	872/P14	A50	914	A98	975/R	H15	998/VS	H13
780/1	A33	872/P14 Ti	A50	915	A102	975/V	H15	999/A	H12
780/2	A33	873/PH2	A51	916	A101	977	H7	999/AS	H13
780/3	A33	874/P1	A48	917	A97	978/AR	H4	999/FG	H12
780/4	A33	874/P2	A48	918/1	A101	978/AZ	H4	999/FGS	H13
785/1L	A33	875/12 S	A48	918/2	A101	978/BL	H4	1000/V	H11
785/1R	A33	876/22	A48	918/3	A101	978/GI	H4	1000/VF	H11
785/11L	A33	876/23	A48	918/4	A101	978/RA	H4	1001/C	H11
785/11R	A33	877/HK4	A51	919/1	A101	978/RO	H4	1001/CF	H11
785/12L	A33	877/HK4 Ti	A51	919/2	A101	978 (UN)	H4	1002/1	H10
785/12R	A33	878	A51	919/3	A101	978/VE	H4	1002/2	H10
790/1	A32	879	A51	919/4	A101	979/BL	H9	1003	D50
790/2	A32	880	A48	920/2	A120	979/G	H9	1004/0	H7
795/1	A34	881	A48	921/1	A100	979/R	H9	1004/1	H7
795/2	A34	882	A51	921/2	A100	979/W	H9	1004/2	H7
795/3	A34	882/Ti	A51	922/1	A100	980/9-AR	H4	1005/C	H11
795/4	A34	883	A50	922/2	A100	980/9-AZ	H4	1005/FC	H11
795/5	A34	884	A50	922/3	A100	980/9-BL	H4	1005/FV	H11
796/1	A37	885	A51	923	A102	980/9 (DOI)	H4	1005/V	H11
796/2	A37	886	A100	924	A102	980/9-GI	H4	1006	F20
796/3	A37	886/2	A100	925/1	A103	980/9-RA	H4	1007/10-R	A114
797/1	A35	886/3	A100	925/2	A103	980/9-RO	H4	1007/10-TO	A114
797/2	A35	887/1	A102	925/3	A103	980/9-VE	H4	1007/10-TS	A114
797/3	A35	887/2	A102	925/4	A103	980/10-AR	H4	1007/A	A114, A120
797/4	A35	887/3	A102	925/5	A103	980/10-AZ	H4	1007/R	A114
798/1	A35	888/1	A102	925/6	A103	980/10-BL	H4	1008	F20
798/2	A35	888/2	A102	926/1	A103	980/10-GI	H4	1009	F20
798/3	A35	888/3	A102	926/2	A103	980/10-RA	H4	1011	H7
799/2	A34	888/4	A102	926/3	A103	980/10-RO	H4	1012/OY	A115, A120
799/3	A34	888/5	A102	926/4	A103	980/10 (TRE)	H4	1013/TC	A115
799/5	A34	889/1	A102	926/5	A103	980/10-VE	H4	1014/TC	A115
799/6	A34	889/2	A102	926/6	A103	981/19-AR	H5	1015/TC	A115
799/7	A34	890	A99	941	E10	981/19-AZ	H5	1016/OY	A115
799/8	A34	891	A99	942	E10	981/19-BL	H5	1017	A115
799/9	A34	892	A99	947	G10	981/19-GI	H5	1019	D47
799/10	A34	893	A99	948	G10	981/19 (QUATRI)	H5	1020/0,9-OY	A113, A120
800/1	A36	894/1	A56	949	G10	981/19-RA	H5	1021/1	C21
800/2	A36	894/2	A56	950	E7	981/19-RO	H5	1021/2	C21
800/3	A36	894/3	A56	951	E7	981/19-VE	H5	1022/130	B5
800/4	A36	895/1	A56	952	E7	981/20-AR	H5	1022/150	B5
800/5	A36	895/2	A56	952/20	E7	981/20-AZ	H5	1023	B5
800/6	A36	895/3	A56	952/25	E7	981/20-BL	H5	1024	B5
810/1Ti	A44	896	A98	953/3	E11	981/20 (CINC)	H5	1026	B5
810/2Ti	A44	897/2	A100	953/4	E11	981/20-GI	H5	1027/90	A112
810/3Ti	A44	897/3	A100	953/5	E11	981/20-RA	H5	1027/120	A112
810/4Ti	A44	897/4	A100	953/6	E11	981/20-RO	H5	1027/150	A112
810/5Ti	A44	898/1	A57	954/3	E11	981/20-VE	H5	1027/180	A112
810/6Ti	A44	898/2	A57	954/4	E11	981/ORTO	F25	1028/90-OY	A112
810/7Ti	A44	898/3	A57	954/5	E11	982	H11	1028/120-OY	A112
810/KIT	A44	898/4	A57	954/6	E11	982/A	H11	1028/150-OY	A112
812/1Ti	A45	898/5	A57	955/3	E11	983	H11	1028/180-OY	A112
812/2Ti	A45	899	A97	955/4	E11	983/A	H11	1029	A8
812/3Ti	A45	899/G	A97	955/5	E11	984	H11	1030	A8
812/4Ti	A45	900	A97	955/6	E11	984/A	H11	1031/0,6-OY	A113
812/5Ti	A45	900/G	A97	956/3	E11	985	D48	1032	A93
812/6Ti	A45	901	A99	956/4	E11	986	D48	1033	A93
812/7Ti	A45	902/1	A100	956/5	E11	987	D48	1033/T	A93
812/8Ti	A45	902/2	A100	956/6	E11	988	D48	1034	A117
812/9Ti	A45	902/3	A100	957/1	E20	989	D48	1035/0,6-OY	A113
812/KIT	A45	903/1	A101	957/2	E20, H8	990	D48	1037	A117
818	A98	903/2	A101	957/5	H8	991	D49	1038	A117
820/1	A97	903/3	A101	957/6	H8	992	D49	1040/0,9-OY	A113, A120
820/2	A97	903/4	A101	957/7	H9	993	D49	1042	A113
820/3	A97	905/1	A102	962	H6	994	D49	1044	A113
825/A	A97	905/2	A102	963	H6	995	D49	1045/OY	A115
825/B	A97	906	A99	963/F	H6	996	D49	1046	A115
825/G	A97	907	A98	964	H6	997	D49	1048	A114
826/A	A97	907/C	A98	965/1	D50	998/A	H12	1048/R	A114

1049	A113	1315/2,0	E20	1512	A96	1740	A89	2163	A15
1049/D	A113, B5	1315/2,5	E20	1513	A96	1740/TC	A89	2164	A15
1049/OY	A113, A118	1315/3,0	E20	1517	A94	1741	A89	2168	D46
1050	A113	1315/3,5	E20	1518	A94	1741/TC	A89	2170	D47
1050/D	A113, B5	1315/4,0	E20	1519	A94, F17	1742	A89	2171/1	D44
1050/OY	A113, A118	1315/4,5	E20	1520	A94	1742/TC	A89	2171/2	D44
1052	A115	1315/5,0	E20	1521	A94	1743	A90	2400/1	A23
1059/TC	A115	1315/5,5	E20	1522	A94	1743/C-TC	A90	2400/7	A23
1060/TC	A115	1315/6,0	E20	1523	A94	1743/TC	A90	2400/13	A25
1063	A116, A119	1315/6,5	E20	1524	A94	1744	A92	2400/17	A23
1063/TC	A116	1315/7,0	E20	1526	A94	1744/TC	A92	2400/18	A23
1064/D	A116	1315/7,5	E20	1527	A94	1748	A88	2400/22	A25
1064/OY	A116	1315/8,0	E20	1528	A94	1748/TC	A88	2400/34-N	A23
1064/T	A116	1315/8,5	E20	1529	A94	1749	A92	2400/35-N	A23
1070	A117	1315/9,0	E20	1530/1	A95	1749/TC	A92	2400/51	A25
1072	A117	1315/9,5	E20	1530/2	A95	1750	A91	2400/51-AL	A25
1074	A117	1315/10,0	E20	1530/3	A95	1750/TC	A91	2400/67	A25
1078	A117	1316/1.HL8	E16	1531	A95	1850	F16	2400/67-N	A25
1112	E16	1317/1.HL8	E14	1532	A95	1851	F16	2400/70	A20
1113	E16	1317/1.HL10	E14	1533	A94	1852	F16	2400/74	A25
1118	B5	1317/2.HL8	E14	1534	A94	1853	A87	2400/79	A26
1120	B5	1317/2.HL10	E14	1540	E22	1853/TC	A87	2400/79-N	A26
1122	B5	1317/5.HL8	E12	1541	E22	1854	A87	2400/86	A25
1123	B5	1317/5.HL10	E12	1542	E22	1854/TC	A87	2400/101-BC	A8
1124	B5	1318/2,3	E20	1545	E22	1855	A86	2400/133-BC	A8
1124/D	B5	1318/3,5	E20	1546	E22	1855/TC	A86	2400/151-BC	A8
1126	B5	1318/4,1	E20	1580	D39	1856	A86	2400/187	A26
1126/L	B5	1318/4,6	E20	1629	A96	1856/TC	A86	2400/SET	A26
1128	E16	1318/5,1	E20	1633	A96	1857	A86	2500/1	A10
1129	E16	1319/4C	E20	1634	A96	1857/TC	A86	2500/2	A10
1130	F20	1319/4R	E20	1635	A96	1858/MV	A87	2500/3	A10
1132	F20	1319/5C	E20	1640	H7	1858/MV-TC	A87	2500/4	A10
1134	F20	1319/5R	E20	1641	H7	1862	A91	2500/7	A10
1140	E17	1319/6C	E20	1642	H7	1862/TC	A91	2500/8	A10
1141	C28, E17	1319/6R	E20	1645/1	G10	1910	A83	2500/13	A10
1144/Ti	E16	1320/1	E14	1645/2	G10	1910/TC	A83	2500/13-S	A7
1145/Ti	E16	1320/2	E14	1650/1	A48	1911	A83	2500/17	A11
1148	H14	1321/1	E2	1650/2	A48	1911/TC	A83	2500/18	A11
1149	H14	1321/2	E2	1650/3	A48	1920/C-D	A117	2500/18-A	A11
1150	H14	1321/3	E2	1650/4	A48	1920/D-D	A117, A119	2500/19	A11
1151	H14	1321/4	E2	1651/0	A49	1922/A	A84	2500/20	A12
1152	H14	1321/5	E2	1651/1	A49	1922/A-TC	A84	2500/21	A12
1155	H10	1321/6	E2	1651/2	A49	1922/B	A84	2500/22	A12
1160	H10	1321/7	E2	1651/3	A49	1922/B-TC	A84	2500/22-S	A7
1162	E13	1321/8	E2	1651/4	A49	1922/C	A84	2500/23	A12
1165	H10	1321/9	E2	1651/5	A49	1922/C-TC	A84, A120	2500/24	A12
1200	C23	1321/10	E2	1651/6	A49	1922/D	A84	2500/29	A13
1201	C23	1321/KIT	E2	1651/7	A49	1922/D-TC	A84, A118	2500/29-S	A6
1202	C23	1322/1	E3	1651/8	A49	1923	A90	2500/30	A13
1204	C23	1322/2	E3	1651/9	A49	1923/TC	A90	2500/33	A14
1208	C23	1322/3	E3	1651/11	A49	1924	A88	2500/33-A	A14
1210	C23	1322/4	E3	1651/KIT	A49	1924/TC	A88	2500/33-L	A14
1300/1	E6	1322/5	E3	1651/MN	A49	1925/A	A88	2500/37	A6
1300/2	E6	1322/6	E3	1651/OTT	A49	1925/A-TC	A88	2500/38	A7
1300/3	E6	1322/7	E3	1651/VS	A49	1925/B	A88	2500/39	A6
1300/4	E6	1322/8	E3	1655/1 RS	A48	1925/B-TC	A88	2500/39-A	A6
1300/5	E6	1322/9	E3	1655/2 CB	A48	1925/C	A88	2500/39-L	A6
1300/6	E6	1322/10	E3	1660/1	H7	1925/C-TC	A88	2500/39-R	A6
1300/KIT	E6	1322/KIT	E3	1670/1	B7	1950/KIT	A120	2500/40	A7
1301	E21	1323/1	E4	1671/1	C24	1951/KIT	C27	2500/41	A13
1304/901	E8	1323/2	E4	1671/2	C25	1953/KIT	C26	2500/46	A15
1304/902	E8	1323/3	E4	1671/3	C17	1954/KIT	A118	2500/49	A13
1304/903	E8	1323/4	E4	1671/6	C24	1955/KIT	E23	2500/51	A13
1304/904	E8	1323/5	E4	1671/7	C28	1956/KIT	A119	2500/51-A	A13
1304/905	E8	1323/6	E4	1672/1	A93	1957	A81	2500/51-L	A13
1304/906	E8	1323/7	E4	1672/2	A104	1958	A81, A118	2500/52	A13
1304/907	E8	1323/8	E4	1672/3	A105	1959	A81, A120	2500/54	A11
1304/908	E8	1323/9	E4	1673/1	E15	1960	A81, A120	2500/55	A11
1304/KIT	E8	1323/10	E4	1673/5	E24	1961	A81	2500/67	A11
1305/KIT	E5	1325	E12	1673/7	E24	1970	A81, E17	2500/67-A	A11
1306/8.HL8	E14	1325/A	E12	1675/1	D24	1971	A81, C28, E17	2500/68	A15
1309/1	E9	1325/LR	E12	1675/2	D24	2000/A	A85	2500/73	A12
1309/2	E9	1325/LRA	E12	1675/3	D10	2000/A-TC	A85	2500/73-L	A12
1309/3	E9	1330	E15	1675/4	D10	2000/B	A85	2500/73-S	A12
1309/4	E9	1330/F	E15	1675/5	D11	2000/B-TC	A85	2500/74	A14
1309/5	E9	1331/1	E15	1675/9	D52	2000/C	A85	2500/74-D	A14
1309/6	E9	1331/1F	E15	1675/10	D35	2000/C-TC	A85	2500/74-M	A14
1309/7	E9	1331/2	E15	1680/1	F22	2000/D	A85	2500/74-N	A14
1309/8	E9	1331/2F	E15	1680/2	F22	2000/D-TC	A85	2500/75	A10
1309/9	A118, E9	1340/1R	E10	1680/3	F23	2004	A86	2500/75-A	A10
1310/1S	E11	1340/2A	E10	1680/4	F23	2004/TC	A86	2500/76	A14
1310/2S	E11	1340/3R	E10	1736	A89	2010	A92, E17	2500/76-N	A14
1310/3S	E11	1340/4A	E10	1736	A90	2012	A92, C28, E17	2500/79	A12
1310/4D	E11	1350/KIT	E23	1736/TC	A90	2162/A	A15, D47	2500/79-A	A12
1310/5D	E11	1510	A96	1739	A89	2162/C	A15, D47	2500/86	A12
1310/6D	E11	1510/1	A96	1739/TC	A89	2162/R	A15, D47	2500/86-C	A12

2500/87	A12	2650/150 Pedo	A9	3000/95	F10	3541	A67	3638/69	A55, C28
2500/88	A27	2650/151	A19	3000/96	F10	3542	A67	3638/Ti	A55, C28
2500/89	A11	2650/151-A	A19	3000/97	F10	3543/AN	A72	3639	A55
2500/90	A11	2650/151-AS	A19	3000/98	F10	3543/OR	A73	3640/1	A54
2500/91	A12	2650/151 Pedo	A9	3000/99 TC	F4	3544/AN	A72	3640/2	A54
2500/94	A11	2650/203	A19	3000/171	F13	3544/OR	A73, A119	3640/3	A54
2500/95	A11	2650/203 Pedo	A9	3000/PR5	F14	3545/AN	A72	3801	A58
2500/96	A11	2650/210	A19	3000/PR8	F15	3545/OR	A73	3802	A58
2500/97	A11	2650/222	A19	3161	H18	3546/AN	A72	3803	A58
2500/98	A27	2650/286	A19	3162	H18	3546/OR	A73	3804	A58
2500/99	A12	2650/SET PEDO	A9	3163	H18	3547	A67	3805	A58
2500/101	A13	2810	G20	3164	H18	3548	A67	3806	A59
2500/107	A10	2811	F20	3175/O	H18	3549/AN	A72	3807	A59
2500/108	A14	2815/1	F20	3175/R	H18	3550	A79, F21	3808	A59
2500/110	A14	2815/2	F20	3180	H18	3550/TC	A79	3809	A59
2500/111	A14	2817	F21	3182	H18	3551	A79, F21	3810	A59
2500/113	A13	2821	H16	3184	H18	3551/TC	A79	3811	A59
2500/114	A14	2822	F17	3187	H18	3552	A67	3812	A58
2500/122	A10	2823	D36, F17	3188	H18	3553	A67	4155	F11, H17
2500/123	A7	2824	F17	3190	H18	3557	A68	4160	F11, H17
2500/130	A16	2825	F17	3191	H18	3558	A73	4558	G10
2500/136	A10	2825/ORTO	F16	3192	H18	3558/TC	A73	4559	G10
2500/137	A10	2826	F17	3501	A69	3559	A73	4562	D38
2500/138	A6	2915	H21	3502	A69	3559/TC	A73	4562/1	D38
2500/139	A13	2918	H20	3503	A68	3560/C	A67	4563	D38
2500/143	A14	2918/1	H20	3504/1	A69	3560/R	A67	4564	D38
2500/147	A13	2918/2	H20	3504/2	A69	3562/C	A67	4565	D38
2500/148	A12	2918/3	H20	3504/LH	A76	3562/R	A67	4566	D39
2500/157	A6	2918/O	F26	3505	A66	3564/C	A67	4567	D39
2500/158	A6	3000/15	F13	3506	A68	3564/R	A67	4567/R	D39
2500/159	A6	3000/18 TC	F5	3506/120	A68	3565	A70	4568/TC	D38
2500/160	A7	3000/20	F8	3508	A68	3566	A70	4569	D37
2500/161	A7	3000/21	F7	3509	A69	3567	A70	4569/1	D37
2500/162	A7	3000/23	F7	3509/TC	A74	3568	A70	4569/2	D37
2500/163	A6	3000/23 TC	F7	3510	A69	3570/9	A79	4569/3	D37
2500/180	A10	3000/25 TC	F6	3510/AN	A72	3570/11	A79	4569/4	D37
2500/181	A10	3000/28	F11	3510/TC	A74	3571	A71	4569/6	D37
2500/182	A10	3000/29	F13	3511	A66	3572	A71	4570	D37
2500/185	A15	3000/30	F9	3511/90	A66	3573	A71	4571	D37
2500/187	A15	3000/31	F6	3511/TC	A74	3574	A71	4571/1	D37
2500/189	A13	3000/32	F6	3512	A66	3575	A71	4571/2	D37
2500/190	A13	3000/34	F9	3512/90	A66	3576	A71	4571/3	D37
2500/221	A16	3000/35	F9	3512/LH	A76	3577	A71	4572	D37
2500/223	A16	3000/36	F15	3512/TC	A74	3580	A71	4572/1	D37
2500/350	A16	3000/38C TC	F8	3513	A66	3581	A71	4572/2	D37
2500/351	A16	3000/39 TC	F7	3514	A68	3584	A71	4573/D	D38
2500/SET-10	A17	3000/40C TC	F8	3515	A71	3585	A63	4574/D	D38
2500/SET-12	A17	3000/43	F12	3515/TC	A75	3585/BLK	A65	4575	D39
2600/101	A5	3000/45	F15	3516	A71	3586	A63	4576/A	D38
2600/111	A5	3000/47 TC	F7	3516/TC	A75	3586/BLK	A65	4576/R	D38
2600/115	A5	3000/49	F14	3517	A71	3587	A63	4577/1	D39
2600/122	A5	3000/50	F14	3518	A68	3587/BLK	A65	4577/2	D39
2600/150	A5	3000/51	F9	3518/TC	A74	3588	A63	4577/3	D39
2600/160	A5	3000/52	F9	3519	A68	3588/BLK	A65	4577/4	D39
2600/170	A5	3000/53	F11	3519/LH	A76	3589	A63	4578	E21
2600/SET	A5	3000/54	F8	3519/TC	A74	3589/BLK	A65	4580	E21
2650/1	A18	3000/55	F10	3520	A78, A93	3590	A77	4583	G19
2650/5	A19	3000/56	F12	3521	A78, A93	3591	A63	4584	G19
2650/6	A19	3000/57	F8	3521/160	A78	3591/BLK	A65	4585	G19
2650/10-S	A18	3000/58	F9	3522	A79, F21	3594	A77	4854	D27, E13
2650/15	A19	3000/59	F13	3522/TC	A79, F21	3596	A77	4855	D27
2650/16	A19	3000/60	F12	3523	A70	3621	A80	4856	D27
2650/16 Pedo	A9	3000/61	F13	3523/TC	A75	3624	A80	4856/1	D27
2650/17	A19	3000/62	F15	3524	A70	3626	A80	4857	D27
2650/17 Pedo	A9	3000/63	F12	3524/TC	A75	3627	A80	4857/2	D27
2650/18-L	A18	3000/69 TC	F3	3525	A68	3628	A80	4858	D27
2650/18-L Pedo	A9	3000/69 TC LL	F3	3525/TC	A74	3629	A53	4858/3	D27
2650/18-R	A18	3000/70	F11	3526	A70	3630	A53	4859	D26
2650/18-R Pedo	A9	3000/72	F6	3526/TC	A75	3631	A53	4861/1	D26
2650/23	A19	3000/74 TC	F3	3527	A70	3632/A	A53	4861/2	D26
2650/24	A18	3000/76 TC	F3	3527/TC	A75	3633	A53	4861/3	D26
2650/32	A18	3000/79	F11	3528	A78, A93	3634	A53	4861/4	D26
2650/32-A	A18	3000/80	F12	3528/TC	A75	3635/10	A53	4861/MOD	E13
2650/53-L	A18	3000/81	F11	3529/TC	A75	3635/11	A53	4862/1	D26
2650/53-R	A18	3000/82	F14	3530	A78	3635/12	A53	4862/2	D26
2650/65	A19	3000/83	F14	3531	A78	3635/12D	A53	4862/3	D26
2650/65 Pedo	A9	3000/84	F6	3532	A78	3635/13	A53	4863	D27
2650/69	A19	3000/85 TC	F4	3533	A78	3635/15	A53	4864	D27
2650/69 Pedo	A9	3000/85 TC 15°	F4	3534	A78	3635/15C	A53	4865	D26
2650/88-L	A18	3000/86 TC	F7	3535	A71	3636	A55	4866	D26
2650/88-R	A18	3000/87 TC	F5	3536	A71	3637/11	A54	4867	D26
2650/99-C	A18	3000/87 TC 15°	F5	3537/TC	A75	3637/16	A54	4869	D27
2650/103	A19	3000/89 TC	F4	3538	A78	3638	A55, A118-A120	4870	F21
2650/150	A18	3000/91 TC	F4	3538/TC	A75	3638/64	A55	4871	F21
2650/150-A	A18	3000/92 TC	F5	3539/TC	A75	3638/65	A55	4873	F21
2650/150-AS	A18	3000/94 TC	F5	3540/TC	A75	3638/67	A55, A118	4873/PR	F21

4874/1	F20	4979/1	D29	6000/KIT	G12	6008/24 KIT	G18	6018/L2	G17
4874/2	F20	4979/2	D29	6000/KIT-SB	G19	6008/L1	G18	6018/L3	G17
4876/1	F20	4979/3	D29	6000/L1	G12	6008/L2	G18	6018/L4	G17
4876/2	F20	4979/4	D29	6000/L2	G12	6008/L3	G18	6018/U1	G17
4880	D26	4979/5	D29	6000/L3	G12	6008/L4	G18	6018/U2	G17
4881	E13	4979/6	D29	6000/L4	G12	6008/L5	G18	6018/U3	G17
4882	E13	4979/7	D29	6000/L5	G12	6008/L6	G18	6018/U4	G17
4883	E13	4979/8	D29	6000/L6	G12	6008/L7	G18	6100/15	H16
4884	E13	4979/9	D29	6000/U1	G12	6008/L8	G18	6100/15 Blu	H16
4885/BC	E13	4979/10	D29	6000/U2	G12	6008/L9	G18	6100/15 Verdi	H16
4886	E13	4979/11	D29	6000/U3	G12	6008/L10	G18	6140	F24
4887	E13	4979/12	D29	6000/U4	G12	6008/L11	G18	6141	F24
4888	E13	4979/13	D29	6000/U5	G12	6008/L12	G18	6142	F24
4892	E12	4980/C	G20	6000/U6	G12	6008/L13	G18	6150	D51
4895	E12	4981/M	G20	6001/KIT	G15	6008/P1	G18	6152	D51
4900	B4	4982	G20	6001/L1	G15	6008/P2	G18	6152/SCR	D51
4902	B4	4983	G20	6001/L2	G15	6008/P3	G18	6160/B	D51
4902/MM	D47	4984	G20	6001/L3	G15	6008/P4	G18	6160/G	D51
4903/3	B3	4985	G20	6001/L4	G15	6008/U1	G18	6160/R	D51
4903/4	B3	4986	G20	6001/L5	G15	6008/U2	G18	6161/A	H15
4903/4MA	B3	4987/1R	E21	6001/U1	G15	6008/U3	G18	6161/B	H15
4903/4RO	B3	4987/2A	E21	6001/U2	G15	6008/U4	G18	6161/W	H15
4903/5	B3	4988	G20	6001/U3	G15	6008/U5	G18	6162	H15
4903/5MA	B3	4989	E21, G20	6001/U4	G15	6008/U6	G18	6163	H16
4903/5RO	B3	4990	G10	6001/U5	G15	6008/U7	G18	6163/S	H16
4903/6	B3	4990/1	G10	6002/KIT	G15	6009/KIT	G14	6164	A108
4903/10RO	B2	4990/2	G10	6002/L1	G15	6009/L1	G14	6166	C14
4904	B4	4990/3	G10	6002/L2	G15	6009/L2	G14	6169	C22
4905/6	B4	4991	G10	6002/U1	G15	6009/L3	G14	6170	D51
4905/8	A119, B4	4991/1	G10	6002/U2	G15	6009/L4	G14	6200	D49
4905/8MV	B4	4991/2	G10	6003/4DR	G12	6009/L5	G14	6201/D	D49
4905/10	B4	4995/1R	E21	6003/4SL	G12	6009/L6	G14	6201/V	D49
4906/BL	B4	4995/2A	E21	6003/KIT	G12	6009/U1	G14	6204/G	D49
4906/GR	B4	5222	G11	6003/L1	G12	6009/U2	G14	6204/R	D49
4906/RE	B4	5223	G11	6003/L2	G12	6009/U3	G14	6210	H16
4906/SI	B4	5224	G11	6003/L3	G12	6009/U4	G14	6300	D27, H14
4906/YE	B4	5550	D36	6003/L4	G12	6009/U5	G14	7060	H22
4910/4RO	B3	5551	D36	6003/L5	G12	6010/KIT	G15	7120	H22
4910/5RO	B3	5552	D34	6003/L6	G12	6010/L1	G15	7500/20	A43
4930	D28	5553	D34	6003/U1	G12	6010/L2	G15	7500/22	A43
4940/1	A107	5554	D34	6003/U2	G12	6010/L3	G15	7500/KIT	A2
4940/2	A107	5560/2	D36	6003/U3	G12	6010/U1	G12	8330	A94
4941/1	A107	5570	D36	6003/U4	G12	6010/U2	G15	8332	A94
4941/2	A107	5580	D36	6003/U5	G12	6010/U3	G15	8334	A94
4942/1	A107	5590	D36	6003/U6	G12	6011/KIT	G14	8336	A94
4942/2	A107	5595/0	D31	6005/1LP	G13	6011/L1	G14	8338	A94
4953/1	A107	5595/1	D32	6005/1UP	G13	6011/L2	G14	8340	A94
4953/2	A107	5595/1A	D32	6005/4DR	G13	6011/L3	G14	8350	A94
4955/A	G13	5595/2A	D32	6005/4SL	G13	6011/L4	G14	8352	A94
4955/B	G13	5595/3	D34	6005/KIT	G13	6011/L5	G14	8354	A94
4955/P	G13	5595/4	D35	6005/L1	G13	6011/L6	G14	8356	A94
4955/R	G13	5595/5	D35	6005/L2	G13	6011/U1	G14	8358	A94
4955/S	G13	5595/7	D34	6005/L3	G13	6011/U2	G14	8360	A94
4956	A108	5595/8	D35	6005/L4	G13	6011/U3	G14	8400	H17
4958/1	A108	5595/8A	D33	6005/L5	G13	6011/U4	G14	8535	A94
4958/2	A108	5595/9	D31	6005/L6	G13	6011/U5	G14	8537	A96
4959/1	A108	5595/10	D33	6005/U1	G13	6012/UCB	G15	8538	A96
4959/1 NOA	A108	5595/11	D33	6005/U2	G13	6013/KIT	G16	8540	A96
4959/2	A108	5595/12A	D34	6005/U3	G13	6013/L1	G16	9952/160 TC	F5
4959/2 NOA	A108	5595/13A	D34	6005/U4	G13	6013/L2	G16		
4960	A108	5595/14	D33	6005/U5	G13	6013/L3	G16		
4961	A108	5595/14A	D33	6005/U6	G13	6013/L4	G16		
4962/1	A109	5595/18	D33	6006/4DR	G14	6013/U1	G16		
4962/2	A109	5595/27	D32	6006/4SL	G14	6013/U2	G16		
4963/1	A109	5595/28	D33	6006/L1	G14	6013/U3	G16		
4963/2	A109	5595/29	D32	6006/L2	G14	6013/U4	G16		
4964/AM-DA	A111	5595/51	D33	6006/L3	G14	6014/KIT	G16		
4964/AM-INOX	A110	5595/56	D34, D33	6006/L4	G14	6014/L1	G16		
4964/AM-OR	A111	5595/56S	D33	6006/L5	G14	6014/L2	G16		
4964/AM-SI	A111	5595/201	D35	6006/L6	G14	6014/L3	G16		
4964/EU-DA	A111	5595/202	D34	6006/U1	G14	6014/L4	G16		
4964/EU-INOX	A110	5595/203	D34	6006/U2	G14	6014/U1	G16		
4964/EU-OR	A111	5595/204	D34	6006/U3	G14	6014/U2	G16		
4964/EU-SI	A111	5595/205	D35	6006/U4	G14	6014/U3	G16		
4970	D28	5595/206	D32	6006/U5	G14	6014/U4	G16		
4971	D28	5595/208	D32	6006/U6	G14	6017/KIT	G17		
4972/NS	D28	5595/210	D31	6007/24	G18	6017/L1	G17		
4972/WL	D28	5595/212	D31	6007/100	G18	6017/L2	G17		
4973	D28	5595/W8A	D33	6007/L1	G18	6017/L3	G17		
4974/5	D29	5605	D34	6007/L2	G18	6017/L4	G17		
4974/6	D29	5610/M-B	D30	6007/L3	G18	6017/U1	G17		
4974/7	D29	5610/M-V	D30	6007/L4	G18	6017/U2	G17		
4975	D28	6000/1LP	G12	6007/U1	G18	6017/U3	G17		
4976	D28	6000/1UP	G12	6007/U2	G18	6017/U4	G17		
4977	D28	6000/4DR	G12	6007/U3	G18	6018/KIT	G17		
4978	D28	6000/4SL	G12	6007/U4	G18	6018/L1	G17		



Medesy thanks those who have contributed to the catalogue creation, in particular: Dr. Giuliano Corrozzatto.

Ideazione e direzione artistica
Studio Fabbro – Italy

Impaginazione grafica e realizzazione
Studio Fabbro – Italy

Impianti e Stampa
Lito Immagine srl – Rive d'Arcano (UD)

Edizione **G-M19**

Printed in November 2018
Stampato in Novembre 2018

© COPYRIGHT MEDESYS SRL

The present catalogue has been registered and referenced under your name nevertheless it will remain a full property of MEDESYS; its use is limited exclusively to the purchase or sale of MEDESYS products. The reproduction and the use of the images and/or texts illustrated on the catalogue are strictly prohibited. This catalogue is addressed only to dental specialists. MEDESYS reserves the right to undertake all the modifications on its products, which may be deemed necessary to obtain a technical improvement or to adapt to a different surgical utilization.

© DIRITTI MEDESYS SRL

Questo catalogo, che sarà sempre di nostra proprietà, è stato registrato e numerato sotto il Vostro nome; il suo uso è limitato esclusivamente all'acquisto o alla vendita di prodotti MEDESYS. La riproduzione o l'uso delle illustrazioni e/o testi riportati in questo catalogo, sono rigorosamente proibiti. Il presente catalogo è indirizzato esclusivamente a personale medico qualificato. MEDESYS si riserva modifiche sugli strumenti che si rendessero necessarie per ragioni di progresso tecnico o variazione di impiego chirurgico.



MEDESYS SRL

Viale dell'Industria, 1 – Industrial area
33085 Maniago, PN – Italy
Tel. (+39) 0427.72786
Fax (+39) 0427.71541
www.medesys.it – info@medesy.it